

Laboratory  
characterisation of  
exoplanetary  
atmospheres through  
infrared spectroscopy

Eszter DUDÁS



# CONTENTS

I. Objectives

II. Introduction

III. Experimental approach

IV. Results and conclusions

V. Further challenges



# I. Objectives

# e-PYTHEAS project

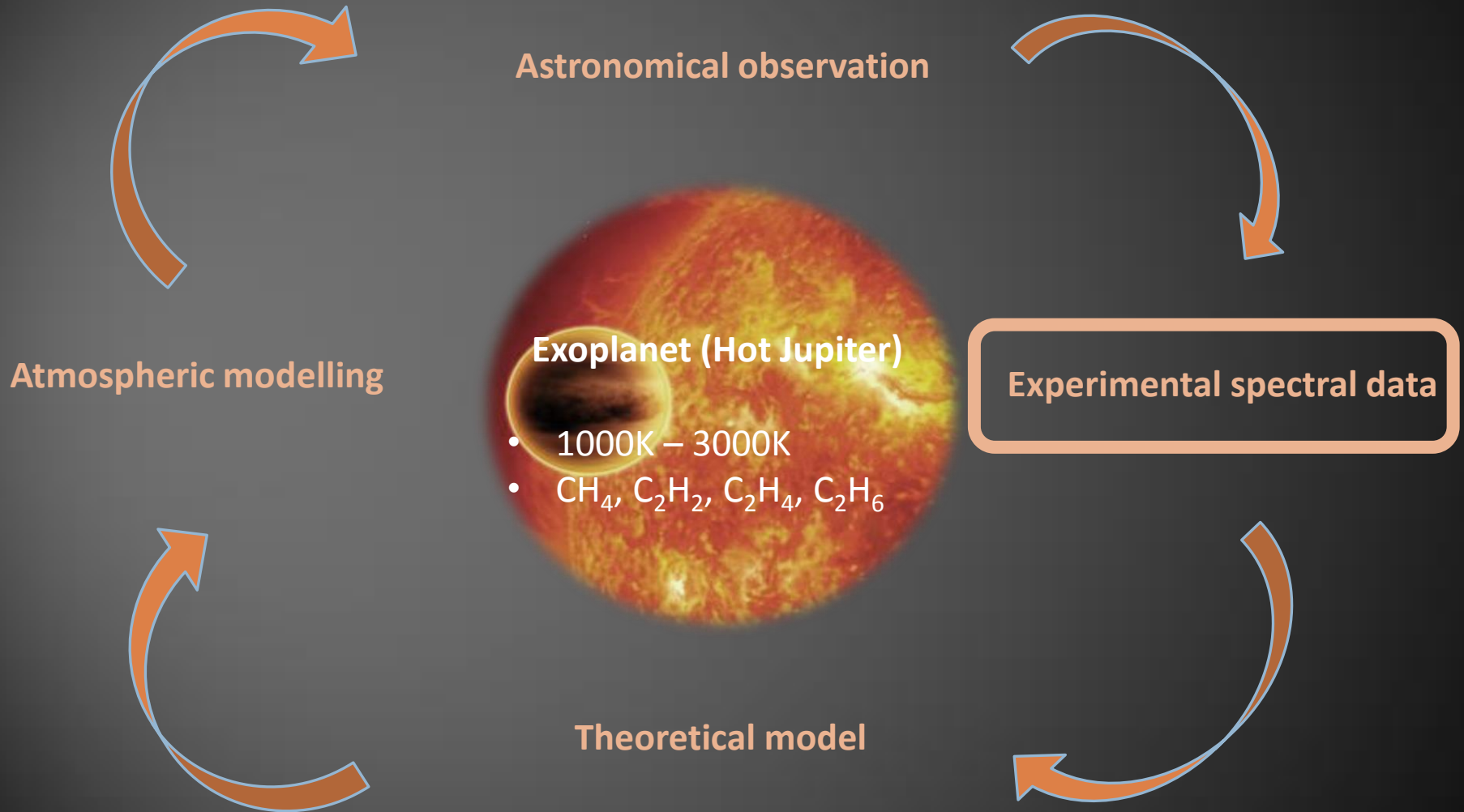



## II. Introduction

High energy

Excited states

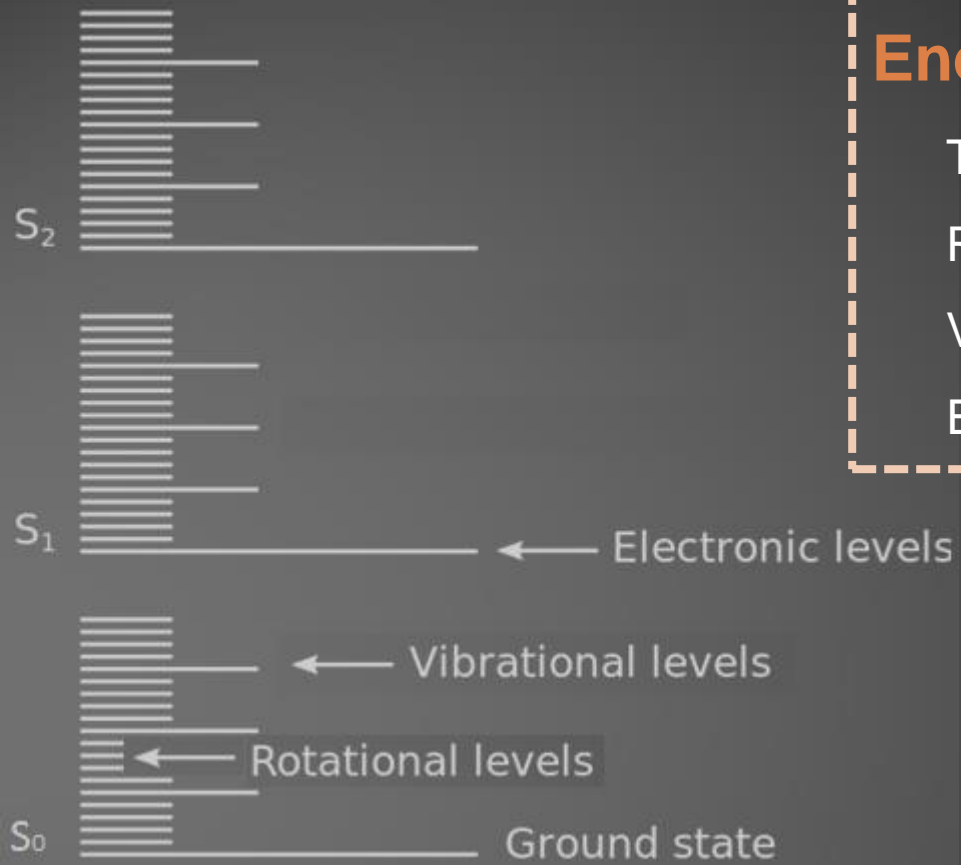

## Energy levels

- Translational
- Rotational
- Vibrational
- Electronic

Low energy

$S_0$

Ground state

$S_1$

Electronic levels

Vibrational levels

Rotational levels

$S_2$

High energy

Excited states

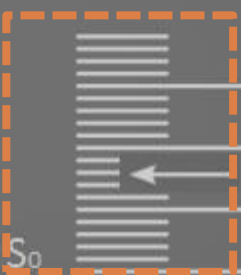

## Energy levels

- Translational
- Rotational
- Vibrational
- Electronic

Electronic levels

Vibrational levels

Rotational levels

Ground state

Low energy

Infrared

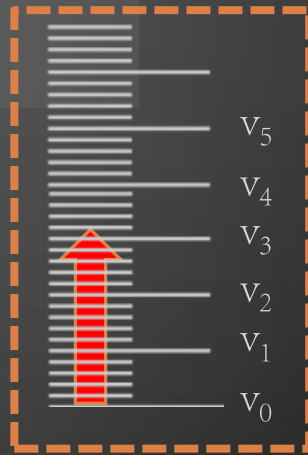

High energy

Excited states

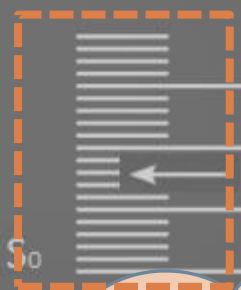

Low energy

← Electronic levels

← Vibrational levels

← Rotational levels

Ground state

## Energy levels

- Translational
- Rotational
- Vibrational
- Electronic

$$N_J \propto g_J \cdot e^{-\frac{E_J}{k.T}}$$

Thermal distribution

Infrared

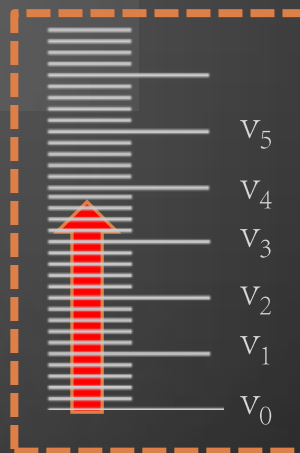



# Molecule CO

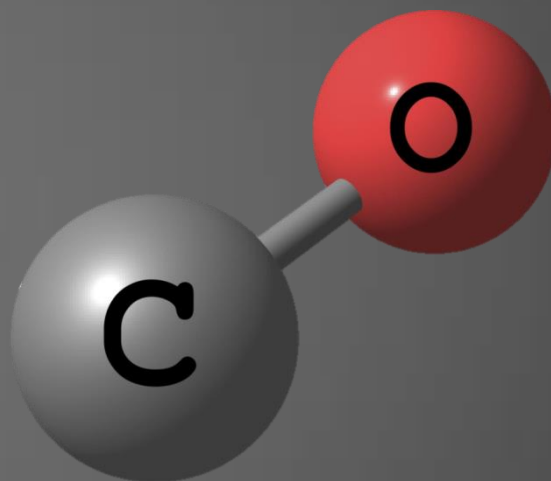

# Translation

$$M = \frac{u}{a} = \frac{u}{\sqrt{\gamma \cdot R \cdot T}}$$

1)  $u = 0 \frac{m}{s}$   $\triangleright \triangleright M = 0$

2)  $T \rightarrow 0 K$   $\triangleright \triangleright M \rightarrow +\infty$

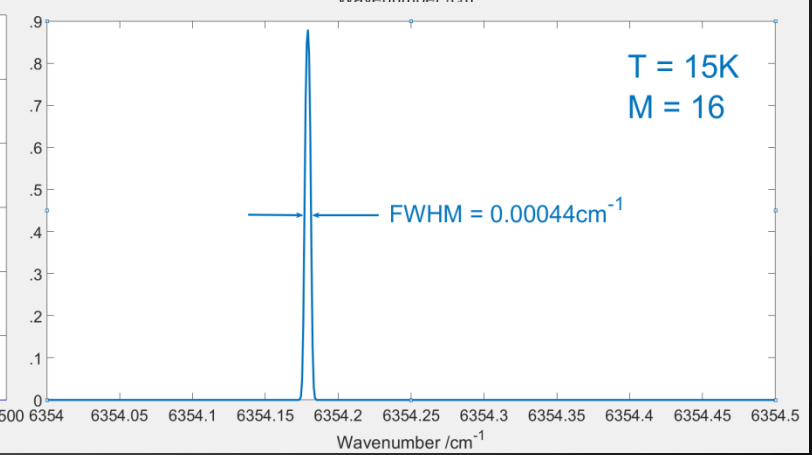
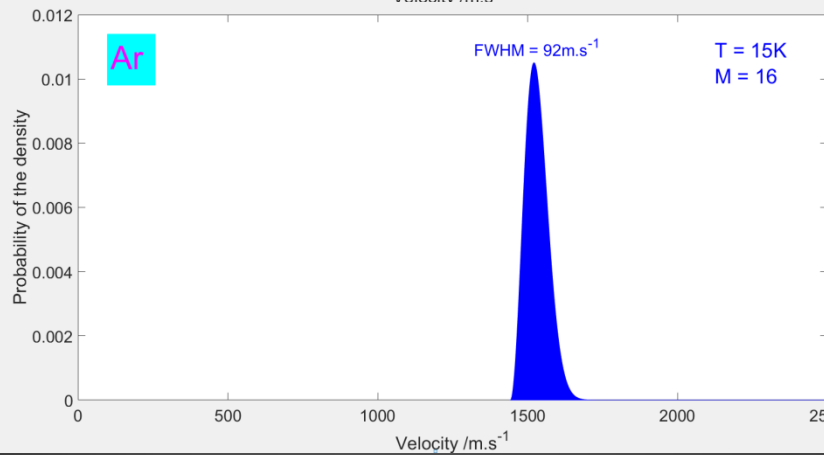
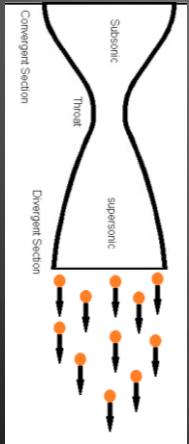
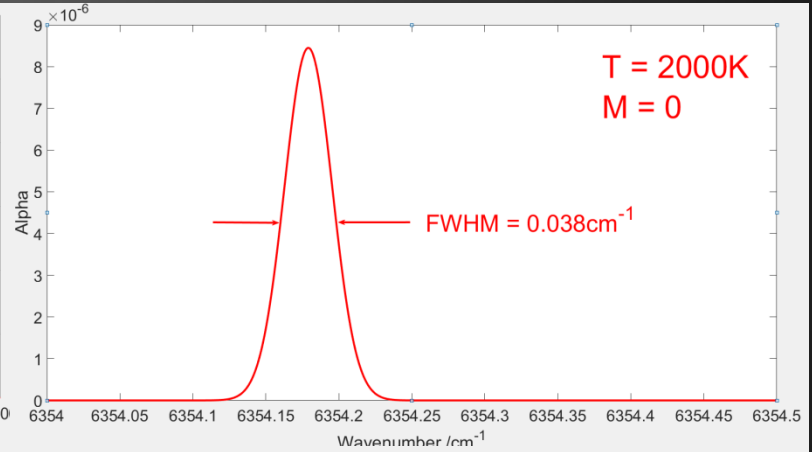
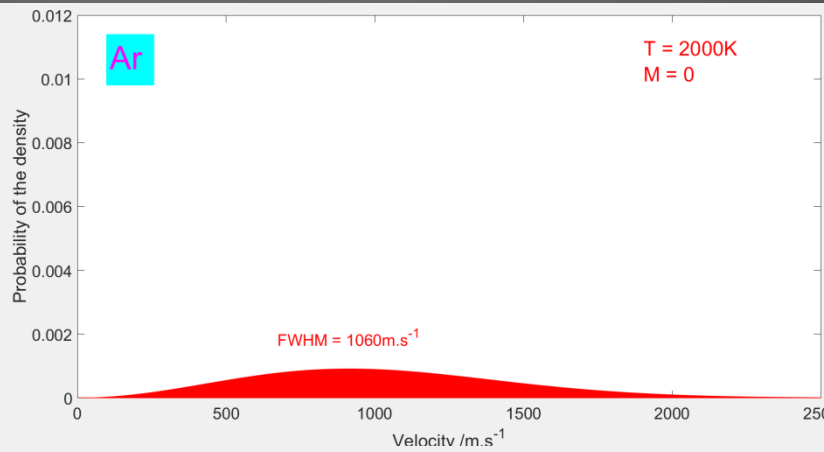

# Rotation

## Distribution of the population

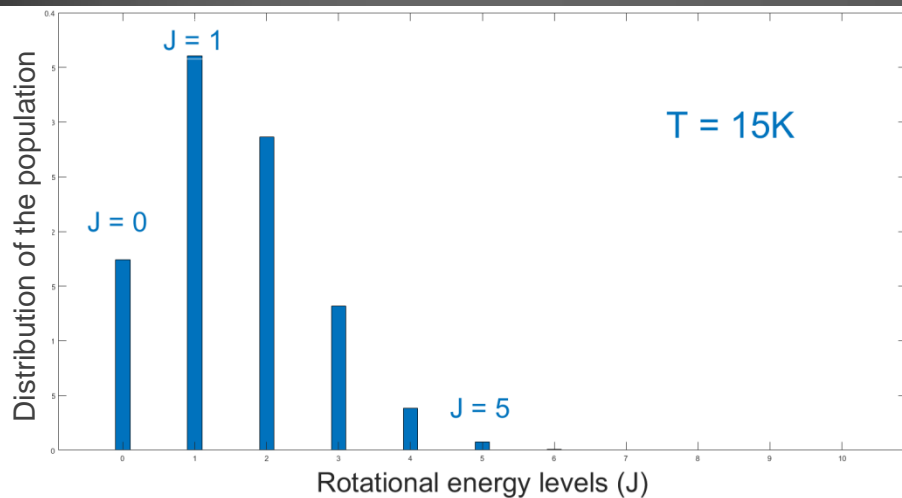

## Corresponding spectra

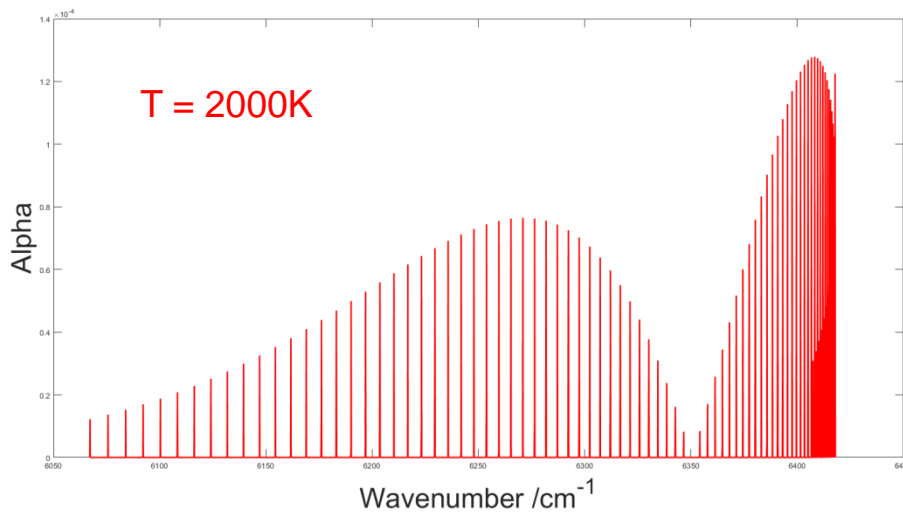
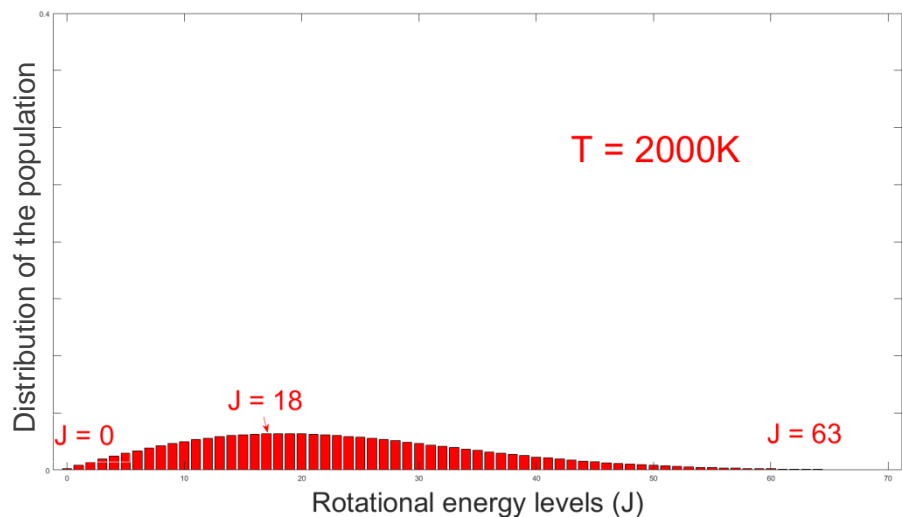
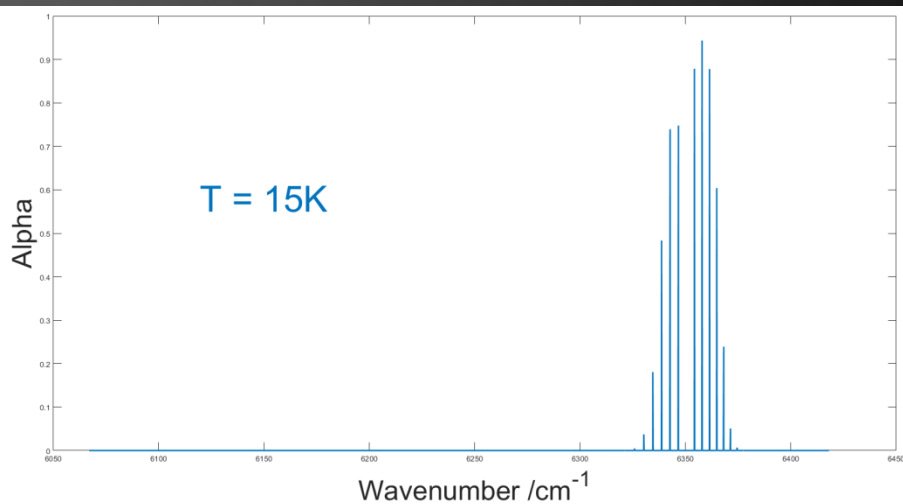

# Vibration

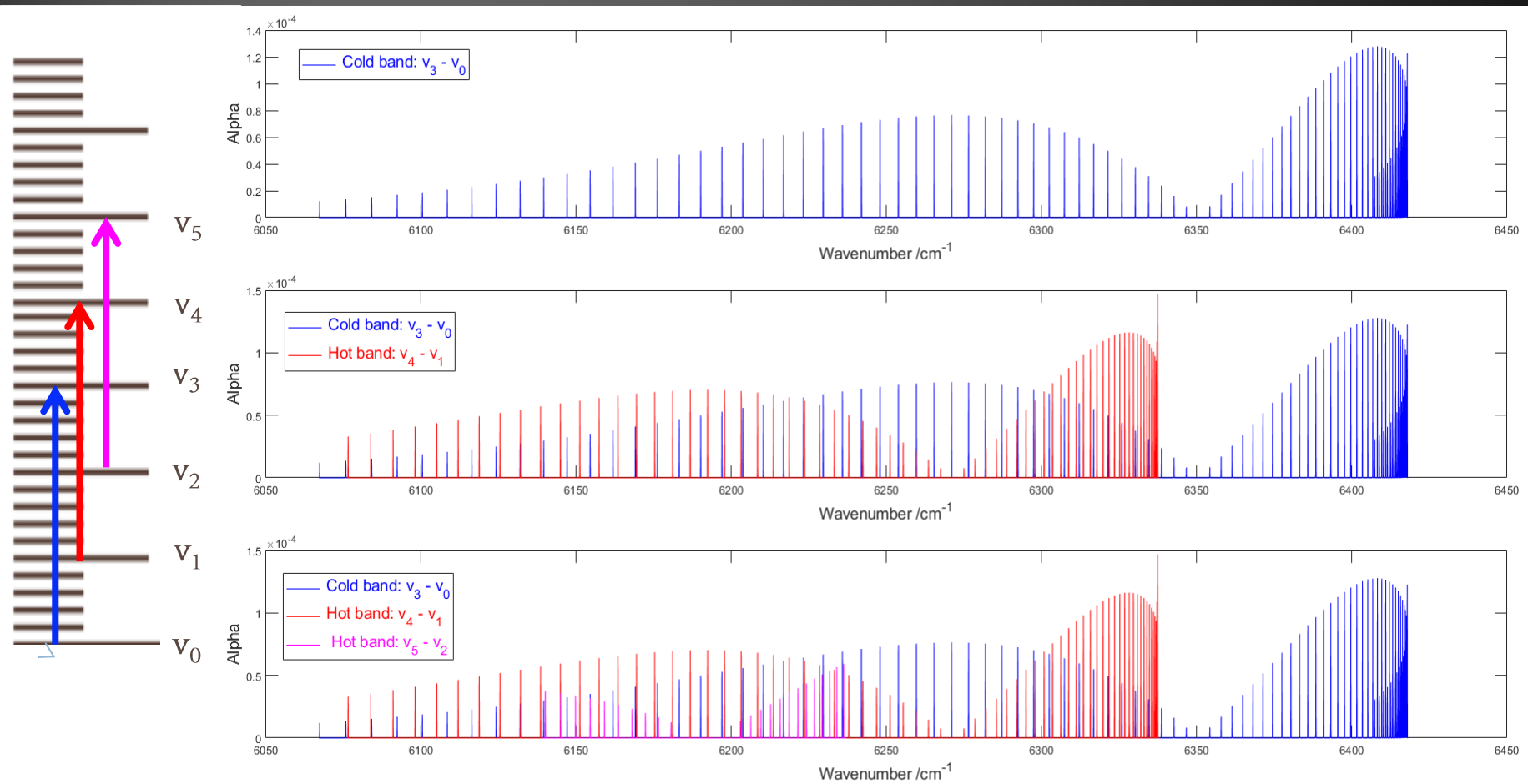

# Non Local Thermodynamic Equilibrium

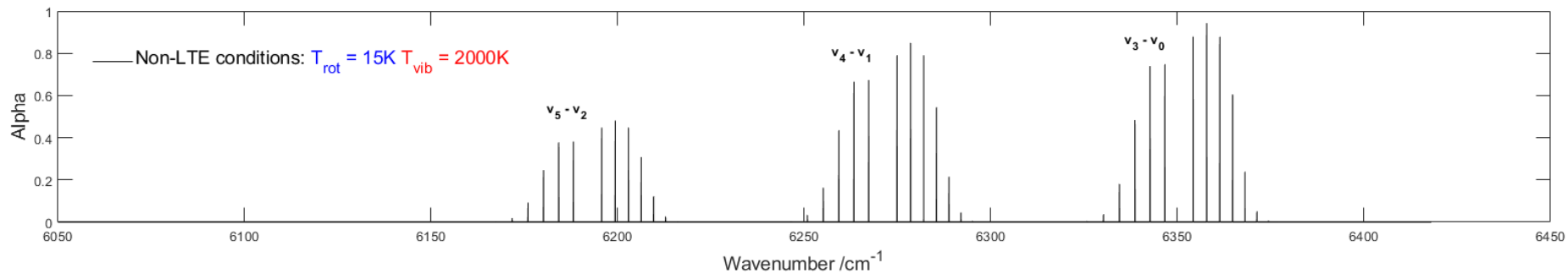
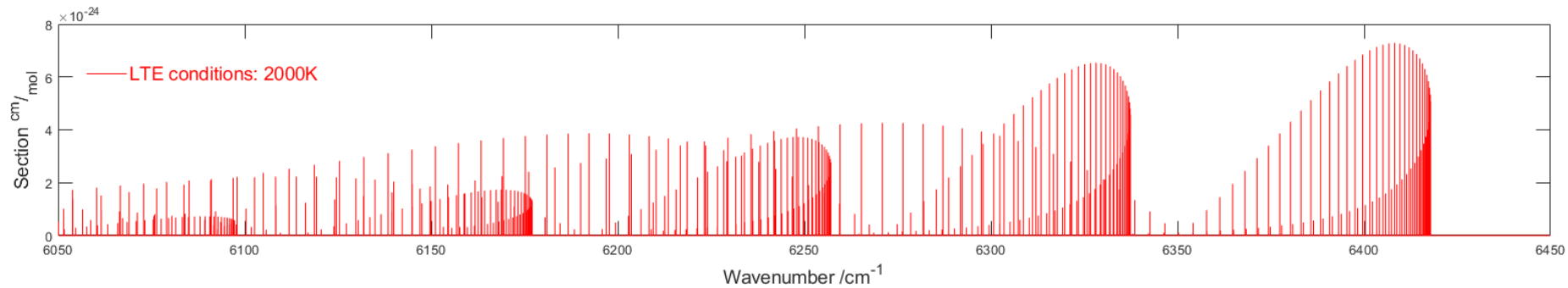
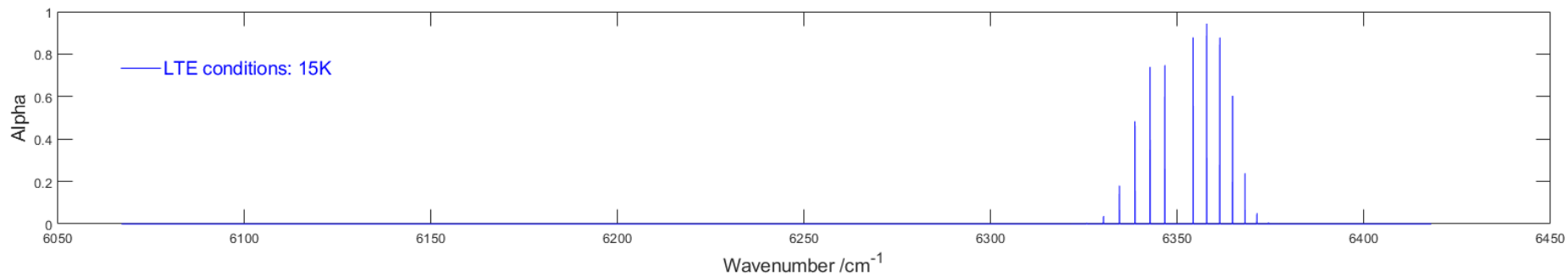



### III. Experimental approach

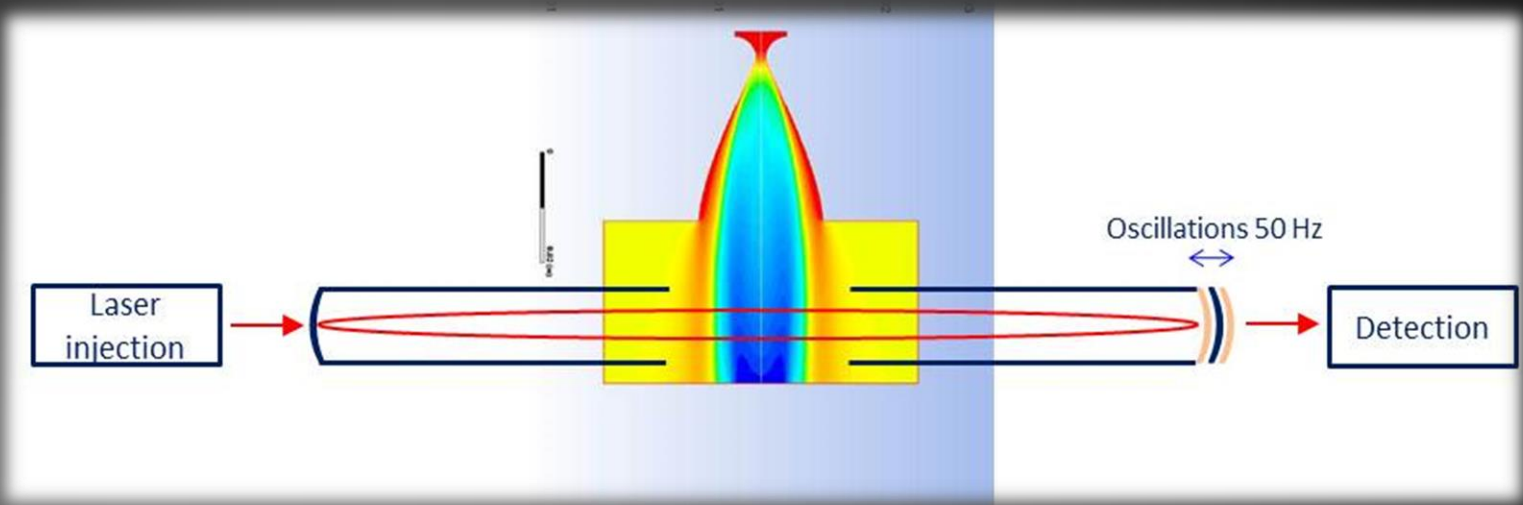

Hypersonic jet cavity ring down spectroscopy

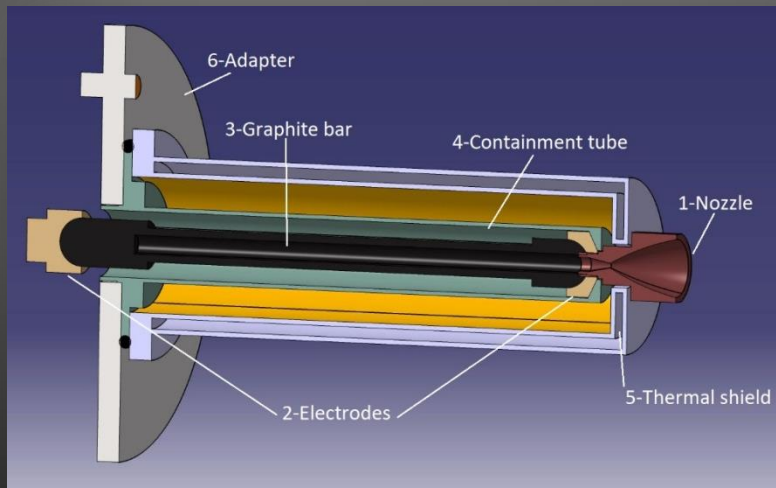

High Entalpy Source

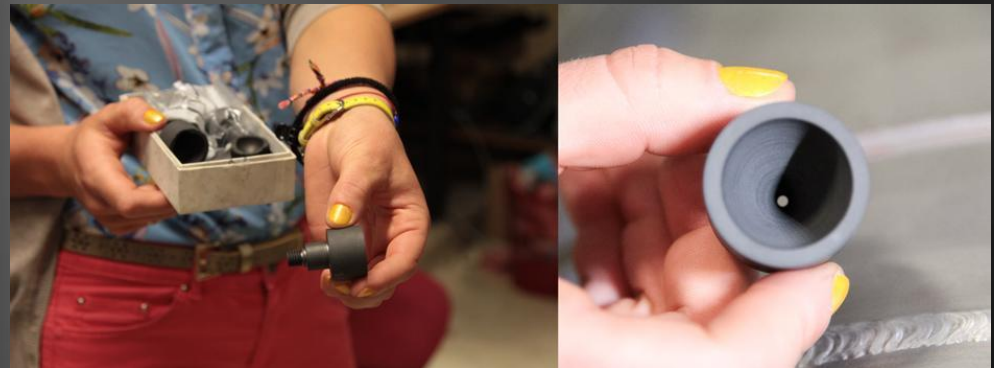

Small dimensional de Laval nozzle



## IV. Results & conclusions



# Cavity Ring Down Spectroscopy

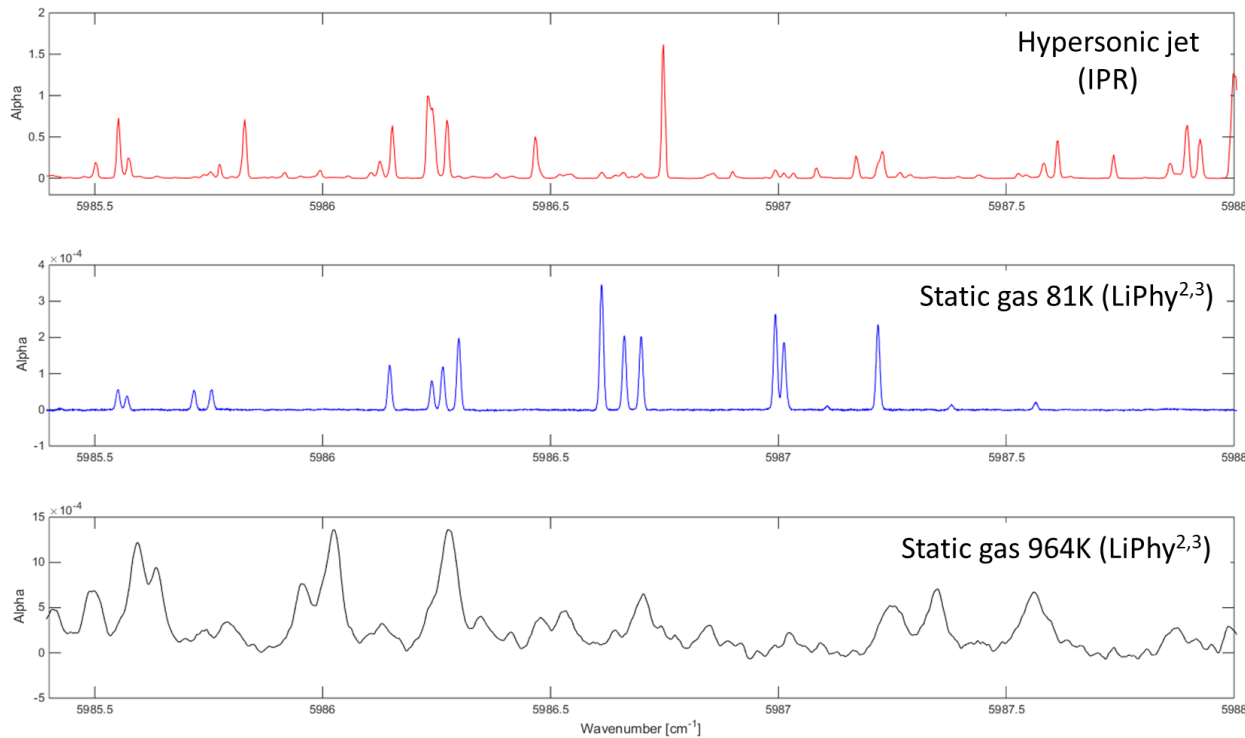

CRD Spectrum of methane

High  $T_{\text{vib}}$   
Low  $T_{\text{rot}}$   
Low  $T_{\text{trans}}$

$$T_{\text{vib}} = T_{\text{rot}} = T_{\text{trans}}$$

Overcrowded spectrum  
(super lines)

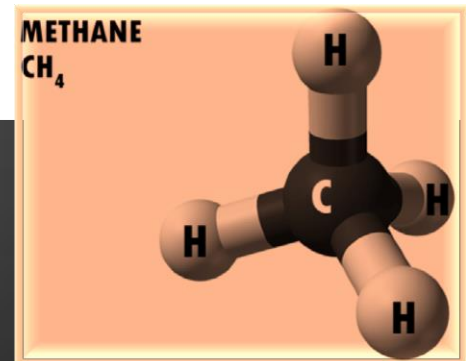

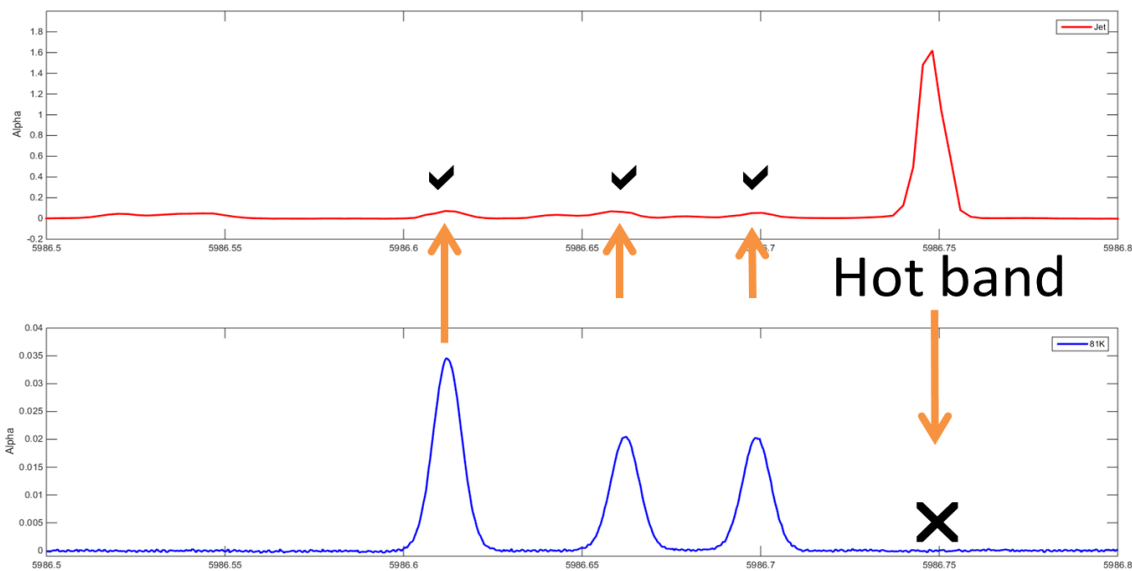

GS depopulated (low cold band intensity)  
High vibrational levels thermally populated (Intense hot bands)

Cold bands only (molecular population is mainly on GS)



## IV. Further challenges

Unwanted shear  
layer absorption

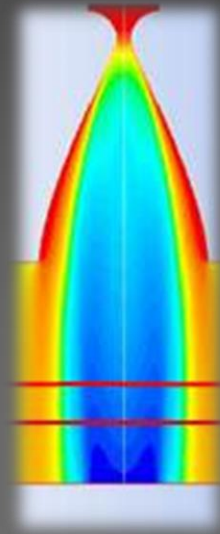

Design of a planar nozzle  
(*collaboration with Indian  
Institute of Technology  
Guwahati*)

New system for  
heating up the gases

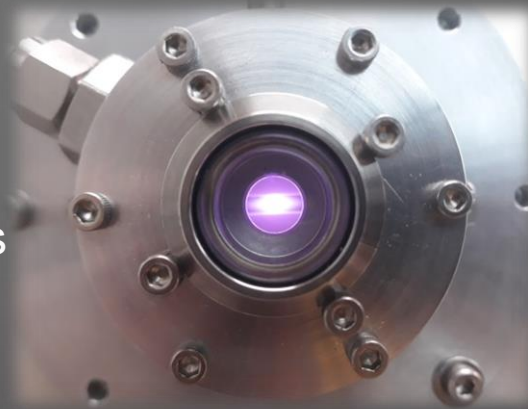

New plasma source  
(*collaboration with  
Division of Space Plasma  
Power and Propulsion  
ANU Australia*)

Thank you for your kind attention!

