



HAL
open science

Mothering influences domestic chick's laterality

Soline Galuret, Sophie Lumineau, Damien Pouzol, Isabelle George

► **To cite this version:**

Soline Galuret, Sophie Lumineau, Damien Pouzol, Isabelle George. Mothering influences domestic chick's laterality. *Animal Behaviour*, 2020, 159, pp.69-79. 10.1016/j.anbehav.2019.11.005 . hal-02329598

HAL Id: hal-02329598

<https://univ-rennes.hal.science/hal-02329598>

Submitted on 20 May 2020

HAL is a multi-disciplinary open access archive for the deposit and dissemination of scientific research documents, whether they are published or not. The documents may come from teaching and research institutions in France or abroad, or from public or private research centers.

L'archive ouverte pluridisciplinaire **HAL**, est destinée au dépôt et à la diffusion de documents scientifiques de niveau recherche, publiés ou non, émanant des établissements d'enseignement et de recherche français ou étrangers, des laboratoires publics ou privés.

Mothering influences domestic chick's laterality

Soline GALURET, Sophie LUMINEAU, Damien POUZOL and Isabelle GEORGE*

Univ Rennes, Normandie Univ, CNRS, EthoS (Éthologie animale et humaine) - UMR 6552, F-35000 Rennes, France

*Correspondence:

Isabelle George

UMR6552 – Ethologie Animale et Humaine

Université Rennes 1 – CNRS

263 Avenue du Général Leclerc

Campus de Beaulieu – Bât. 25

35042 Rennes Cedex, France

Tel: +33223236863, e-mail: isabelle.george@univ-rennes1.fr

© 2019. This manuscript version is made available under the CC-BY-NC-ND 4.0 license
<http://creativecommons.org/licenses/by-nc-nd/4.0/>

Publisher's version available at the following:
<https://dx.doi.org/10.1016/j.anbehav.2019.11.005>

Laterality is the prevalence of one side of the body to perform motor acts and perceptual functions. The evolution of directional biases that are consistent across individuals of a group may have been constrained by the opportunity for asymmetric animals to interact with other asymmetric animals. If we assume that social animals have more opportunity to interact with each other than solitary animals, we could expect that the more social animals are, the more lateralized and the more aligned they are. In precocial birds, the mother is the first and most important social partner and she has a strong influence on her young's social motivation. We therefore wondered whether she could also influence the laterality of its young. In order to see whether mothering influences the laterality of its young, we compared behaviours of non-brooded and brooded domestic chicks (*Gallus gallus domesticus*). We assessed both individual- and group-level laterality during the mothering period. We also measured sociality and emotivity of both types of chicks. We found that non-brooded chicks were more strongly lateralized, more social and less emotional than brooded chicks. Asymmetrical bias was also more consistent across non-brooded chicks than across brooded chicks. These results show a postnatal influence of mothering on the development of laterality in the domestic chick, and a link between laterality and sociality. Several hypotheses could explain how the mother's presence and behaviour can modify her young's laterality. We will have to test these hypotheses in order to uncover the mechanisms that are at play. The influence of mothering on the lateralisation of young may have implications in both individual and group performance and fitness. Studying it further may therefore help us to understand better the evolution of laterality and its potential benefits.

Keywords: emotivity, group bias, individual laterality, maternal deprivation, social motivation.

The first studies on asymmetries have been made on humans' brain and animals' behaviours in the middle of the 19th century (Broca, 1861; Soulé, 1967). Although clearly related, central (brain) asymmetries can be distinguished from peripheral asymmetries. Peripheral behavioural asymmetries, also called laterality, are defined as the prevalence of one side of the body to perform motor acts and perceptual functions (Azémar, 1975). Many forms of behavioural asymmetries have been observed, such as handedness, footedness, eye dominance, ear preference and turning biases. Indeed, laterality is widespread across animals, be it invertebrates (Frasnelli et al., 2014; Schnell, Bellanger, Vallortigara, & Jozet-Alves, 2018; Schnell, Jozet-Alves, Hall, Radday, & Hanlon, 2019; see also Frasnelli, 2017 and Frasnelli, Vallortigara, & Rogers, 2012 for reviews) or vertebrates (e.g. in fishes: Bisazza, Cantalupo, Capocchiano, & Vallortigara, 2000; amphibians: Bisazza, De Santi, Bonso, & Sovrano, 2002; Robins, Lippolis, Bisazza, Vallortigara, & Rogers, 1998; Vallortigara, Rogers, Bisazza, Lippolis, & Robins, 1998; lizards: Deckel, 1995; birds: Vallortigara, Regolin, & Pagni, 1999; terrestrial mammals: Farmer, Krüger, Byrne, & Marr, 2018 and aquatic mammals: Karenina, Giljov, Glazov, & Malashichev, 2013; see also Rogers, Vallortigara, & Andrew, 2013 and Vallortigara & Versace, 2017 for general reviews). Laterality thus probably appeared very early in the evolution of vertebrates and asymmetry in invertebrates may be homologous to that in vertebrates (Rogers & Vallortigara, 2015).

Two levels of laterality are usually distinguished. Individual-level lateralization is when an individual exhibits a directional bias or preference that is not necessarily the same as its conspecifics, whereas populational-level lateralization means that the majority of individuals within a population are lateralized in the same direction (Soulé, 1967). According to Vallortigara and Rogers (2005), these two levels of laterality would have evolved in two stages. First, the need for an increased brain efficiency would have led to individual-level lateralization. For instance, lateralized chicks are able to perform two tasks simultaneously, whereas non-

lateralised chicks are not (Rogers, Zucca, & Vallortigara, 2004). Then, when asymmetrical organisms have to interact with each other, it may be advantageous for individuals to align and to have the same directional bias (Ghirlanda, Frasnelli, & Vallortigara, 2009; Ghirlanda, & Vallortigara, 2004; Vallortigara, 2006). Thus, social pressures may have played a role in the evolution of a common direction of asymmetries among the individuals of a group (*i.e.* population-level lateralization). Some studies investigated whether population lateralisation might have been developed in relation to the need to maintain coordination among individuals in behaviours associated with social life. For instance, Bisazza and colleagues (2000) studied different species of fish in order to see whether shoaling was associated with an aligned detour bias. Out of 16 species, all species found to be gregarious showed a turning bias at the population-level whereas only 40% of the species found to be non-gregarious were lateralized at this level (Bisazza et al., 2000). Although the correlation was not perfect, population-level lateralization appears to be correlated with social behaviours. Similar results were found in invertebrates: social honeybees show a population-level bias in their antennal use that is not observed in solitary mason bees (Anfora, Frasnelli, Maccagnani, Rogers, & Vallortigara, 2010). Moreover, honeybees show a strong preference to use their right antenna in social interactions (Rogers, Rigosi, Frasnelli, & Vallortigara, 2013) and mason bees show a consistent directional bias when it comes to species-typical interactive behaviours such as agonistic interactions (Rogers, Frasnelli, & Versace, 2016).

Within social as well as solitary species, populational-level laterality has been observed in several social contexts. A left-side bias seems to exist during social interactions (e.g. in fishes: Sovrano, Bisazza, & Vallortigara, 2001; tadpoles: Bisazza et al., 2002; sheep: Versace, Morgante, Pulina, & Vallortigara, 2007 and apes: Quaresmini, Forrester, Spiezio, & Vallortigara, 2014), and also during mother-infant interactions (see Karenina & Giljov, 2018 for a review). This preference may be because the left side of the body usually predominates in

both agonistic (e.g. in flies: Benelli et al., 2015; lizards: Deckel, 1995 and monkeys: Casperd & Dunbar, 1996) and affiliative behaviours (e.g. in horses and ponies: Farmer et al., 2018; monkeys: Boeving, Belnap, & Nelson, 2017 and dolphins: Sakai, Hishii, Takeda, & Kohshima, 2006). A review of functional lateralization in social recognition points toward a right hemisphere dominance, in particular for discrimination of social companions and individual (or familiarity-based) recognition, whereas the left hemisphere could be specialized for “category-based” distinctions (e.g. conspecifics versus heterospecifics) (Rosa Salva, Regolin, Mascalcioni, & Vallortigara, 2012). However, probably because it depends on what message is conveyed, laterality appears less consistent across species when it comes to communication, with no consensus about the preference for one acoustic hemi-field while listening to conspecifics (e.g. left bias for dogs: Reinholz-Trojan, Włodarczyk, Trojan, Kulczyński, & Stefańska, 2012 and monkeys: Lemasson et al., 2010 and right bias for monkeys: Böye, Güntürkün, & Vauclair, 2005 and sea-lions: Hauser & Andersson, 1994). Moreover, in monkeys and apes, orofacial expressions (e.g. in monkeys: Hauser & Akre, 2001 and apes: Fernández-Carriba, Loeches, Morcillo, & Hopkins, 2002) and gestural communication (e.g. in monkeys: Meguerditchian, Molesti, & Vauclair, 2011 and apes: Prieur, Pika, Barbu, & Blois-Heulin, 2018) show opposite patterns of lateralization. In any case, conspecifics appear to be a crucial factor in laterality expression. For instance, mice and rats copy a task with the same laterality as their demonstrator (Collins, 1988; Heyes & Dawson, 1990). In birds, some precocial species monitor a familiar conspecific with one eye preferentially and an unknown conspecific with the other eye (e.g. in quails: Zucca & Sovrano, 2008; in domestic chicks: Vallortigara, Cozzutti, Tommasi, & Rogers, 2001).

Laterality has been extensively studied in the precocial bird model, especially the domestic chick (Rogers & Andrew, 2002). The domestic chick displays visual (Rogers et al., 2004), auditory (Miklósi, 1996), olfactory (Vallortigara & Andrew, 1994) and motor (Tommasi &

Vallortigara, 1999) asymmetries. This laterality is partly determined by perinatal experiences (Vallortigara et al., 2001). Post-hatching visual/social experience with other chicks for example influences the development of chicks' laterality (Deng & Rogers, 2002). However, a postnatal maternal influence on the development of chicks' laterality has never been observed. Yet, the mother increases its young's survival by modulating its physiology and its morphology, but also its behavioural development. For instance, brooded chicks have a more continuous feeding activity (chickens: Wauters, Richard-Yris, & Talec, 2002) and are less neophobic (Perré, Wauters, & Richard-Yris, 2002) than non-brooded chicks. They are also less aggressive (chickens: Perré et al., 2002) and stay closer to each other in a normal life situation (quails: Bertin & Richard-Yris, 2005). Since mothering has an influence on the emotivity and social behaviours of chicks, and if laterality and sociality have been intertwined through evolutionary social pressures, one would expect that the mother could influence the degree of laterality of her young. By comparing the laterality and the behavioural profile of brooded and non-brooded domestic chicks, our study evaluates for the first time the effect of the mother on its chick's laterality at both the individual and the group levels.

METHODS

Ethical Note

All the experiments were carried out in accordance with the European Communities Council Directive of 22th September 2010 (2010/63/EU) and were approved by the regional ethics committee (French "Comité Rennais d'Ethique en matière d'Expérimentation Animale / n°7", permit number: APAFIS#17476-2018110716226608 v2).

Replacement: Replacement was not possible to achieve our scientific objectives, which relied on behavioural observations of live animals.

Reduction: We reduced the numbers of animals affected by the experiment to the lowest number of individuals necessary while still ensuring the ability to achieve statistical power and the aims of the experiment.

Refinement: We made all efforts to design and conduct the study as carefully as possible to maximize the scientific benefit while minimizing suffering to the animals. We explain how below.

We monitored the weight of the animals throughout the experiments. We made daily observations in order to record the behaviour and to evaluate the general condition of the animals. This allowed us to detect any sign of discomfort or suffering. We treated any injury with an antiseptic (Vétédine®, Vetoquinol, Magny-Vernois, France) and applied a spray dressing (Aluspray) to protect the wound. Every chick showing signs of hypothermia or distress was isolated in a heated cage and returned to its home cage as soon as it recovered. If the chick could not return to its cage, another chick replaced it. No animal lost more than 10% of its weight, decreased its food intake or modified its behaviour to the point we needed to place it in an environment favouring recovery (e.g. individual cage with heating). We never had to use euthanasia (although we planned it as a last resort using a pentobarbital injection – 140 mg/kg).

Our procedures involved no invasive technique. We identified all the animals with one plastic ring on each leg. We made only behavioural observations and tests. We placed one-way mirrors in front of the cages in order not to disturb the animals during behavioural observations. The same person made all the observations and tests. Behavioural tests required us to place the animals individually in a dedicated experimental device. These tests lasted no more than 7 min for the hens and 5 min for the chicks, thus limiting the isolation period. We tested the animals only once a day as often as possible and twice a day exceptionally. Our procedure required that we removed chicks from the cages and thus separated them from their mother once a day during 28 days (exceptionally twice a day for three days) for no more than 30 min. We always removed

all the chicks of one cage together in order to limit isolation. Daily separation probably stressed the mothers but they showed no difference in their behaviour toward chicks before and after separation.

After about two months together in an outdoor aviary, we placed hens in individual cages progressively: we first placed two hens in a double cage (100x148x63 cm) before dividing the cage in two individual cages (100x74x63 cm) where they stayed until the end of the experiments. Hens had access to a sand bath once a week during one month (when in pair in double cages) and then continuously until two weeks before maternal induction. From the time when the hens moved to the experimental room to the time when the experiments with the chicks ended, housing conditions included enrichment such as a nest box with straw and a perch, artificial turf on about half of the cage, and 20 g of wheat every day. Non-brooded chicks had free access to a heater placed in the nest box. All the animals were in the same room. They could hear but not see each other across cages. We described all other experimental procedures in the manuscript. The person who made daily care was the same during the whole procedure. This person refilled food trays and water dispensers every day, and cleaned them three times a week. He/she made quick clean-ups two times a week, and a major clean-up involving intrusion into the cage once a week. There was no intrusion into the cage during brooding and maternal induction.

Before and after the experiments we kept the adult hens ($N = 10$) together in an outdoor aviary equipped with shelters, vegetation and food and water ad libitum. We did not use them for other experiments. At the end of the experiments, we gave all the remaining chicks ($N = 39$; two chicks died during the experiment and one died after the experiment while waiting for adoption) to foster families.

Subjects and Housing Conditions

Adoptive mothers

We used ten 8-month-old bantam Pekin hens that came from an industrial farm (La Ferme de Beaumont, Eu, France). One month before the start of the mothering experiment, we placed them in individual cages (100x74x63 cm) with opaque lateral walls that prevented visual and tactile contacts but not auditory communication. Artificial lighting followed a LD 12:12 cycle and the temperature of the room was 21 °C. Food (mixed corn and wheat pellets) and water were available *ad libitum* and we gave about 20 g of wheat once a week as an enrichment. Females had also access to a nest box (50x30x34 cm) filled with straw and equipped with a perch and to an artificial turf (74x45 cm) (Figure 1).

Chicks

Chicks came from eggs artificially incubated in the laboratory. These eggs came from a bantam line of the French National Institute of Agronomic Research (INRA, Nouzilly, France). We placed 165 fertilised eggs in an incubator for 18 days at 37.6 °C, 45% of humidity and 45° rotation every 90 min. After 18 days, we candled the eggs and kept 112 eggs containing embryos in hatching conditions for four days at 37.6 °C and 67% of humidity without rotation. Since light is known to modulate the development of some forms of visual lateralization (e.g. Rogers & Bolden, 1991; Mascetti & Vallortigara, 2001; Chiandetti & Vallortigara, 2019; Chiandetti, Galliussi, Andrew, & Vallortigara, 2013), we placed a "daylight" LED (6 400 K, 600 lm) 70 cm in front of the incubator during the whole incubation period. The day of hatching, we placed 42 hatched chicks in six cages each equipped with a heater (35 °C). We identified each chick with one coloured and numbered ring on each leg. Food (mixed pellets) and water were available *ad libitum*. Since maternal behaviour appears more readily when you place chicks under the hen during the night (Richard-Yris, & Leboucher, 1987), chicks stayed in these cages during their first post-hatching day (d1) before we placed them with adoptive mothers in the evening. We weighed chicks at birth and once a week for seven weeks.

Maternal Induction Procedure

We adapted our maternal induction procedure from Richard-Yris & Leboucher (1987a).

In order to stop laying behaviour and stimulate brooding behaviour, we stopped collecting the females' eggs on d-16. When this was not enough, we used a food restriction procedure adapted from Richard-Yris et al. (1987b). A week before hatching, we thus applied a 7-day food restriction (reduction to approximately 75% of the usual daily intake) to five non-brooding hens. At the end of this procedure, seven out of 10 hens had developed a brooding behaviour. Since it is more difficult to induce maternal behaviour in non-brooding hens (Richard-Yris et al., 1987b), we excluded the three non-brooding hens from the experiment.

On the evening of d1, as physical contact facilitates a rapid appearance of maternal behaviour (Richard-Yris & Leboucher, 1987), we locked up each hen in its nest box and we delicately placed three chicks under every female for one night. We also locked up seven groups of three chicks in nest boxes equipped with a heater. The next morning, we opened the nest boxes and we monitored the adoptive mothers' behaviour toward the chicks. If a chick showed signs of hypothermia, we temporarily removed it from its cage and placed it under a heater. No female showed any aggressive behaviour towards the chicks.

During the period of maternal behaviour induction (from d-16 to d1), we did not perform any experimental test and maintenance was reduced to its minimum in order to maximize the induction success.

Experimental Groups

We divided the 42 chicks into two groups: a group of brooded chicks (B group, $N = 21$) and a group of non-brooded chicks (NB group, $N = 21$). We placed 14 sets of three chicks in individual cages in the experimental room (see *Adoptive mothers*) either with an adoptive mother (B group: seven cages, 21 chicks) or with a heater in the nest box (NB group: seven cages, 21 chicks). We removed adoptive mothers and heaters from the cages on d48, after the end of laterality tests (see *Laterality tests and measures*).

Weight at birth did not differ between the two groups (B: $X + SE = 37.1 + 3.4$ g, $N = 21$; NB: $X + SE = 37.9 + 3.2$ g, $N = 21$; t test: $t_{40} = -0.84$, $P = 0.41$). We determined chicks' sex using feather and crest size between d31 and d72 (B: 14 ♀ and 7 ♂; NB: 9 ♀ and 12 ♂).

Laterality Tests and Measures

T-maze test

From d6 to d27, we tested every chick 15 times (no more than once a day) in a T-maze apparatus (Figure 2a). We placed chicks individually in the T-maze stem and they had 300 s to make a choice between the left branch and the right branch of the apparatus. We recorded the chosen side (both legs stepped into the branch, see Figure 2a) and the latency to make the choice. We turned the experimental setup between each test (four orientations, 90° rotations). We made the last two tests (on d23 and d27) in a larger T-maze (Figure 2a) adapted to the size of the chicks. We randomized the order in which the chicks were tested.

We tried to test adult females in a similar apparatus before the mothering period but since they did not move, we did not obtain any T-maze data for them.

Detour test

We measured adult females' laterality before the mothering period (from d-22 to d-19) using a detour test. We used an arena (140x118x80 cm) within which there was an obstacle (39.5x80 cm) with a rectangular window (10x3 cm) through which a hen could see 1.5 g of wheat (placed 65 cm from the obstacle). We placed the hen in front of the obstacle and it had 420 s to reach the food stimulus. We recorded four parameters: (1) the first eye used to look at the stimulus, (2) the detour's latency, (3) the detour's side and (4) the latency to reach the stimulus. We tested each hen three times a day for four days. We rotated the apparatus between each test (two orientations, 180° rotations). We randomized the order in which the subjects were tested.

We also made a detour test with chicks. However, as chicks were not motivated to reach a food stimulus (wheat or usual food), we used a social stimulus that was the two chicks of the

same home cage (Figure 2b). In addition, since chicks are known to be faster to circumvent an obstacle when the stimulus is not visible (Regolin, Vallortigara, & Zanforlin, 1994), we used a solid obstacle (without window). Therefore, it is likely that auditory/olfactory lateralization played a role in this test. However, a preference to restore visual contact with one eye first might also have influenced a directional bias. We placed the chicks in front of the obstacle and they had 240 s to make the detour. We recorded the same parameters as for adult females (except for the first eye used to look at the stimulus). We tested every chick 15 times between d29 and d45 (no more than once a day, except on d43 and d44 when we tested them twice). We randomized the order in which the subjects of the same home cage were tested. We rotated the experimental setup between each test (two orientations, 180° rotations).

Laterality indices

For each subject, we calculated a laterality index: $LI = (\text{Number of left turns} - \text{Number of right turns}) / \text{Total number of turns}$. A negative (respectively positive) LI indicates a left-side (respectively right-side) bias. The absolute value of the LI (ABSLI) gives an idea of the individual laterality strength: the higher the ABSLI is, the more lateralised the subject is. We calculated laterality indices for the T-maze test (LI_T and $ABSLI_T$) and for the detour test (LI_D and $ABSLI_D$).

Since all chicks had to make 15 turns for both laterality tests, they were significantly lateralised from 12 choices onwards on the same side ($LI \leq -0.6$ or $LI \geq 0.6$ and $ABSLI \geq 0.6$).

Behavioural Observations and Measures

Behavioural observations

In order to study temporal coordination and spatial cohesion between chicks, we made behavioural observations in every home cage using instantaneous scan sampling. We made 13 sessions of 30 scans each (1.5 h for each session with 3 min intervals between scans), two in the morning (between 1030 hours and 1200 hours) and 11 in the afternoon (between 1545 hours

and 1815 hours). We recorded locomotive behaviours (walking, running, jumping), feeding behaviours (eating, drinking), exploration (picking at a non-food item), interactive behaviours (vocalizing, pecking at, attacking, chasing, fleeing from another chick or the mother), maintenance behaviours (grooming, defecating), observation (scanning the environment with head movements while standing or laying), immobility (standing without moving) and rest (laying without moving).

We calculated time-budget after merging these behaviours in three categories: low-energy behaviours (maintenance behaviours, observation, immobility and rest), high-energy behaviours (locomotive, feeding and exploratory behaviours) and interactive behaviours.

We recorded the spatial location of every subject using six virtual sections in the cages (Figure 1). We divided the nest box section into two vertical areas (inside and on the nest box).

We made behavioural observations on d10, d15, d17, d21, d23, d29, d30, d34, d35, d36, d37, d41 and d42. From d23 onwards, we also recorded mothers' behaviours and spatial location.

Index of behavioural desynchronization

We calculated an index of temporal behavioural desynchronization (T) between individuals of the same home cage. For each pair of chicks, we attributed a score of 0 when individuals performed the same behaviour and a score of 1 otherwise. The individual index was the sum of scores obtained by one chick for each pair it made with the two other chicks ($0 < T_C < 2$). The higher the index was, the more desynchronized the subjects were. For each cage, we calculated this index for each scan and then averaged the indices of daily scans to obtain an index of desynchronization per chick and per day.

To see whether behavioural coordination between brooded chicks was related to the coordination of each chick with its mother, we calculated a second index T_M for B chicks ($T_M = 0$ when the chick performed the same behaviour as its mother, $T_M = 1$ otherwise).

Index of dispersion

We calculated an index of spatial dispersion (S) using the subjects' location in the home cage. We calculated this index using the number of frontiers between sections a chick had to cross to reach the other chicks. The higher the index was, the more scattered the subjects were ($0 \leq S_C \leq 8$). For each subject, we calculated this index for each scan and then averaged the indices of daily scans to obtain an index of dispersion per chick and per day.

For brooded chicks, we calculated two indices of dispersion. The first index included only the chicks of each cage (in this case, each individual index was the sum of the index obtained with each of the two other chicks: $0 \leq S_C \leq 8$). The second index was estimated considering each B chick's location toward its mother ($0 \leq S_M \leq 4$).

Chicks' Other Behavioural Tests

Social separation

In order to evaluate the chicks' social motivation, we isolated one chick from its conspecifics and placed it in an anechoic chamber in an empty nest box (similar to its familiar nest box) for 180 s. We recorded the latency of the first distress call and the total number of calls. We made this test on d48, that is, the day we removed adoptive mothers and heaters from the home cages. The test did not start before the response to mothers and heaters removal disappeared, and chicks thus had several hours to habituate to being alone with the other chicks.

Runway test

This test measures the motivation of a subject to reach a social stimulus (Suarez & Gallup, 1983). We made it on d48. The apparatus was a long arena (340x40x80 cm) with a cage (23x29.5x41 cm) containing two chicks from the same home cage at one end. We placed the third chick of the cage at the other end of the apparatus and it had 180 s to reach its cage mates. We recorded the first step latency, the latency to reach the other chicks and the order in which chicks were tested.

Emergence test

This test measures the emotivity level by observing the ability to leave a small and dark environment to reach an unknown, large and bright environment (Jones, Mills, & Faure, 1991). On d49, we placed the chicks individually in a habituation box (17x17x17 cm) placed next to the entrance of a larger test box (73x52x26 cm). For 60 s, we recorded the number of distress calls in the habituation box. After 60 s, we opened the door between the two boxes and we recorded the number of calls and the latency to emerge (head, first leg and whole-body latencies) of the smaller box (each subject had 180 s to leave the habituation box). We also recorded the latency of the very first call (be it before or after opening the door).

Statistical analyses

Because of the death of two chicks and of the development of a facial asymmetry in one chick, we finally included in the statistical analyses:

- For the T-maze test: B group: 13 ♀ and 7 ♂, NB group: 9 ♀ and 11 ♂ (total = 20 B and 20 NB),
- For the detour test: B group: 10 ♀ and 7 ♂, NB group: 9 ♀ and 11 ♂ (total = 17 B and 20 NB),
- For social motivation and emotivity tests: B group: 10 ♀ and 7 ♂, NB group: 9 ♀ and 12 ♂ (total = 17 B and 21 NB),
- For observations in home cages:
 - From D10 to D30: B group: 13 ♀ and 7 ♂, NB group: 9 ♀ and 12 ♂ (total = 20 B and 21 NB),
 - From D34 to D42: B group: 10 ♀ and 7 ♂, NB group: 9 ♀ and 12 ♂ (total = 17 B and 21 NB).

Laterality is classically analysed at two levels. The first level of analysis consists in measuring several responses in one individual to assess laterality at the individual-level. The

second level of analysis consists in measuring one response in several individuals to assess laterality at the group-level.

To evaluate individual laterality, we used binomial tests (comparison between the number of left and right turns made by each individual in the 15 test sessions) for both laterality tests (T-maze and detour).

To evaluate the laterality distribution within each group (number of right-biased vs. number of left-biased chicks in the first session only of both laterality tests), we used Fisher tests to compare the observed distributions to a theoretical distribution (50% of subjects choosing the left side). To compare the two groups' laterality distributions (inter-group comparison between B chicks and NB chicks), we used Chi-square tests on the distributions of individuals turning left or right for the first session only of each laterality test. We also used Welsh t tests to check whether mean LI_T and mean LI_D significantly differed from 0 within each group (if $LI \neq 0$, there is a bias at the level of the group).

For all the other measures, we analysed sex and group factors (and their interaction) using two-tailed ANOVAs. If the conditions for the application of an ANOVA were not respected, we used Student's t tests (normal data) or Mann-Whitney tests (non-normal data) to analyse first the intra-group sex effect and then the group effect (either separately for each sex if there was a difference between females and males or after pooling the data of both sexes when there was no difference). For weight data, we tested groups, sex and time/age factors (and their interactions) using repeated measures ANOVAs. For observations in home cages, we tested group and time/age (repetition) factors (and their interaction) using repeated-measures ANOVAs (sex factor was not tested because of the broods' composition heterogeneity).

Finally, in order to analyse the link between laterality and other measures, we made a principal component analysis (PCA). We checked correlations to exclude strongly correlated

measures ($\geq 80\%$). After running the PCA, we compared the two groups using chicks' individual coordinates on the selected components (eigenvalue > 1).

We performed statistical analyses with R v.3.5.3 (R Core Team, 2014) and the threshold of significance was 0.05 for all tests. All tests were two tailed.

RESULTS

Chicks' Growth

Both groups had a similar birth weight (t test: $t_{40} = -0.84$, $P = 0.41$), but NB chicks grew faster (repeated measures ANOVA: Group*Age factor: $F_{1,38} = 6.86$, $P < 0.0001$) and became heavier (repeated measures ANOVA: Group factor: $F_{1,38} = 16.45$, $P = 0.0002$) than B chicks (Table 1). In both groups, males grew faster (repeated measures ANOVA: Age*Sex interaction: $F_{1,38} = 6.87$, $P < 0.0001$) and became heavier (repeated measures ANOVA: Sex factor: $F_{1,38} = 4.59$, $P = 0.04$) than females.

Laterality Assessment

Individual laterality

In the T-maze test, 25% of the chicks (8 out of 20 NB and 2 out of 20 B) were significantly lateralised (binomial tests: $P \leq 0.04$ for the 10 chicks). Two NB chicks (1 ♀, 1 ♂) were left-lateralised and 6 (5 ♀, 1 ♂) were right-lateralised. The two lateralised B chicks (2 ♀) were right-lateralised (Table 2).

In the detour test, 32% of the chicks (6 out of 20 NB and 6 out of 17 B) were significantly lateralised (binomial tests: $P \leq 0.04$ for the 8 chicks). The six lateralised NB chicks (2 ♀, 4 ♂) were right-lateralised. Four B chicks (1 ♀, 3 ♂) were left-lateralised and two (1 ♀, 1 ♂) were right-lateralised (Table 2).

Only three chicks (all NB) were significantly lateralised in both laterality tests. One of these chicks was not lateralised in the same direction in both tests (left in the T-maze test and right in the detour test).

T-maze test

The LI_T of B and NB chicks did not differ significantly (t test: $t_{38} = -0.69$, $P = 0.49$) (Figure 3a). However, only NB chicks' LI_T values were higher than 0 (Welsh t tests: NB: $t_{19} = 2.17$, $P = 0.04$; B: $t_{19} = 2.04$, $P = 0.06$). Hence, NB chicks showed a significant right bias at the level of the group, whereas B chicks showed no significant group bias. However, when we considered only the first T-maze session, the distribution of chicks choosing the left or the right branch did not differ between the two groups (Chi-square: $\chi^2_1 = 0.1$, $P = 0.75$) and this distribution did not differ from a random (50%) distribution within each group (Fisher tests: $P = 1$) (Table 3).

ABSLI_T values show that females were more strongly lateralised than males and that NB chicks were more strongly lateralised than B chicks (ANOVA: Sex factor: $F_{1,36} = 12.98$, $P = 0.001$; Group factor: $F_{1,36} = 7.27$, $P = 0.01$; no Group*Sex interaction: $F_{1,36} = 0.04$, $P = 0.85$) (Figure 3b).

Detour test

NB chicks passed the obstacle more often *via* the right than B chicks (LI_D : ANOVA: Group factor: $F_{1,33} = 8.99$, $P = 0.005$) (Figure 4). Moreover, only NB chicks LI_T values were higher than 0 (Welsh t tests: NB: $t_{19} = 4.38$, $P = 0.0003$; B: $t_{16} = -0.86$, $P = 0.40$). Hence, NB chicks passed the obstacle more often *via* the right whereas B chicks showed no significant group bias. When we considered only the first detour test session, the distribution of chicks passing *via* the left or *via* the right side of the obstacle was not the same in the two groups (Chi-square: $\chi^2_1 = 8.44$, $P = 0.004$) (Table 3). A majority of NB chicks (85%) passed the obstacle *via* the right (Fisher test: $P = 0.04$) whereas B chicks showed no significant group bias (Fisher test: $P = 0.52$) (Table 3).

The laterality strength did not differ between the two groups (ABSLI_D, ANOVA: Group factor: $F_{1,33} = 0.95$, $P = 0.34$).

There was no correlation between values obtained in the T-maze and in the detour test neither for the laterality index (LI, Pearson correlation: $r_p = 0.06$, $N = 37$, $P = 0.72$) nor for the laterality strength (ABSLI, Spearman correlation: $r_s = -0.13$, $N = 37$, $P = 0.46$).

Adoptive mothers' laterality

One out of the seven adult females tested in the detour test (with a food stimulus) did not make enough detours to determine its laterality. Among the six others (who made between eight and 12 detours), two were individually left lateralised (binomial tests: $P \leq 0.04$ in both cases).

There was no correlation between mothers' and their chicks' laterality neither for LI_D (Pearson correlations: $r_p = 0.19$, $N = 17$, $P = 0.49$) nor for ABSLI_D indices (Pearson correlations: $r_p = -0.15$, $N = 17$, $P = 0.57$).

Behavioural and Spatiotemporal Organization in Home Cages

Overall, NB chicks performed more low energy behaviours (repeated measures ANOVA: Group factor: $F_{1,36} = 14.14$, $P = 0.0005$) and fewer high energy behaviours (repeated measures ANOVA: Group factor: $F_{1,36} = 6.12$, $P = 0.02$) than B chicks. On d10 and d17, NB young birds performed fewer interactive behaviours than B young birds (Mann-Whitney tests: d10, $W = 264.5$, $P = 0.03$; d17, $W = 317.5$, $P = 0.0005$), but on d35, NB chicks on the contrary performed more interactive behaviours than B chicks (Mann-Whitney test: $W = 107.5$, $P = 0.02$).

Behavioural desynchronization (T) between chicks increased with time (repeated measures ANOVA: Age factor: $F_{12,451} = 40.86$, $P < 0.0001$, Figure 5). Overall, NB chicks were less desynchronized than B chicks (repeated measures ANOVA: Group factor: $F_{1,39} = 132.56$, $P < 0.0001$). On d23, the more desynchronized B chicks were to each other, the more desynchronized they were to their mother (Spearman correlations: $r_s = 0.47$, $N_{D23} = 20$, $P = 0.03$). It was not the case for other observation days (Spearman

correlations: $-0.40 \leq r_s \leq -0.11$, $N_{D36,D42} = 17$, $P \geq 0.11$, Pearson correlations: $-0.35 \leq r_p \leq 0.37$, $N_{D29,D30} = 20$, $N_{D34-D41} = 17$, $P \geq 0.15$).

Spatial dispersion (S) in the home cages increased with time (repeated measures ANOVA: Age factor: $F_{12,451} = 41.24$, $P < 0.0001$) but this increase differed between the two groups (repeated measures ANOVA: Age*Group factor: $F_{12,451} = 7.38$, $P < 0.0001$, Figure 6). Overall, NB chicks were less scattered in their cage than B chicks (repeated measures ANOVA: Group factor: $F_{1,39} = 147.14$, $P < 0.0001$) (Figure 6). On d23, d29 and d35, the closer B chicks were to each other, the closer they were to their mother (Spearman correlations: $r_s \geq 0.68$, $P \leq 0.001$, $N_{D23,D29} = 20$; Pearson correlation: $r_p = 0.49$, $N_{D35} = 17$, $P = 0.04$). It was not the case for other observation days (Spearman correlation: $r_s = -0.13$, $N_{D42} = 17$, $P = 0.63$; Pearson correlations: $-0.04 \leq r_p \leq 0.47$, $N_{D30} = 20$, $N_{D34-D41} = 17$, $P \geq 0.06$).

The index of chicks' desynchronization (T_C) was negatively correlated with laterality strength in the T-maze ($ABSLI_T$, Spearman correlation: $r_s = -0.34$, $N = 37$, $P = 0.04$) and laterality index in the detour test (LI_D , Spearman correlation: $r_s = -0.38$, $N = 37$, $P = 0.02$). Thus, the less desynchronized the subjects were, the more lateralised they were in the T-maze and the more they passed the obstacle *via* the right in the detour test.

Similarly, the index of chicks' dispersion (S_C) was negatively correlated with laterality strength in the T-maze ($ABSLI_T$, Spearman correlation: $r_s = -0.35$, $N = 37$, $P = 0.03$) and laterality index in the detour test (LI_D , Spearman correlation: $r_s = -0.42$, $N = 37$, $P = 0.01$). Thus, the less scattered the subjects were, the more lateralised they were in the T-maze and the more they passed the obstacle *via* the right in the detour test.

Chicks' Social Motivation and Emotivity

Social separation

During social separation, NB chicks vocalized sooner than B chicks (ANOVA: Group factor: $F_{1,34} = 9.85$, $P = 0.02$). Regarding the number of distress calls, only NB males vocalized more than B males (Tukey HSD tests: ♂, $P = 0.01$; ♀, $P = 0.95$).

Runway

In both groups, the order in which chicks were tested did not affect the measures (Friedman tests: $0.13 \leq \chi^2_2 \leq 1.0$, $0.61 \leq P \leq 0.94$). The latency of the 1st step (Mann-Whitney test: $W = 185.5$, $P = 0.84$) and the latency to join cage mates (ANOVA: Group factor: $F_{1,34} = 0.40$, $P = 0.53$) did not differ between the two groups. Contrary to some studies (Vallortigara, 1992; Vallortigara, Cailotto, & Zanforlin, 1990), we did not find any difference between females and males.

Emergence test

Only head's emergence latency differed between the two groups: NB chicks emerged faster than B chicks (Mann-Whitney test: $W = 263$, $P = 0.01$).

NB females vocalized later than NB males (Tukey HSD test: $P = 0.02$). In contrast, B females vocalized sooner than B males (Tukey HSD test: $P = 0.02$). We found a group effect only for males, with NB chicks vocalising sooner and more before opening the habituation box than B chicks (Tukey HSD tests: 1st distress call latency, $P = 0.0001$; number of distress calls, $P = 0.02$) (Figure 7). We did not find any difference between the two groups in the number of distress calls after opening the habituation box (Mann-Whitney test: $W = 146.5$, $P = 0.35$).

Laterality and Other Behavioural Measures: Multidimensional Analysis

Only two measures were strongly correlated ($\geq 80\%$). Indeed, the more desynchronised the chicks were, the more scattered they were (Spearman correlation: $r_s = 0.90$, $N = 37$, $P < 0.0001$). Since PCA ran with the index of desynchronization only showed the same result as the one ran with the index of dispersion only, we chose to present the PCA ran with the index of dispersion.

A Principal Component Analysis allowed us to identify four components explaining 66.5% of the overall variance. The first component (28.2% of the overall variance) presented negative loadings for the number of calls during social separation and the number of calls during the emergence test (both before opening the habituation box and during the whole experiment), and positive loadings for the detour latency, the first distress call latency during the emergence test and the index of dispersion (Figure 8). On this component, between-group differences depended on the sex (ANOVA: Group* Sex interaction: $F_{1,33} = 4.45$, $P = 0.04$). Females of both groups did not differ (Tukey HSD: $P = 0.27$), but NB males had lower coordinates (i.e. were more social) than B males (Tukey HSD: $P = 0.0003$).

The second component (16.4% of the overall variance) presented a negative loading for the laterality strength in the T-maze (ABSLI_T), and positive loadings for the choice latency in the T-maze and the first call latency during social separation (Figure 8). On this component, NB chicks had lower coordinates (i.e. were more strongly lateralised and more social) than B chicks (ANOVA: Group factor: $F_{1,33} = 8.45$, $P = 0.007$).

The third component (11.6% of the overall variance) presented a negative loading for the body emergence latency, and positive loadings for the laterality index in the detour test (LI_D) and the laterality strength in the T-maze (ABSLI_T). The fourth component (10.1% of the overall variance) presented a negative loading for the latency to join the congeners in the runway test, and positive loadings for laterality strength in the detour test (ABSLI_D) and the laterality index in the T-maze (LI_T). The two groups did not differ on either of these two components (ANOVAs: Group factor: $F_{1,33} \leq 2.02$, $P \geq 0.16$).

DISCUSSION

One of the aims of our study was to see whether mothering has an influence on domestic chicks' laterality. Our results show that non-brooded chicks were more lateralised and more aligned between each other than brooded chicks. Although we observed a right bias instead of

a left bias like in most previous studies (e.g. Casey, 2005; Casey & Karpinsky, 1999; Vallortigara, 2000; Vallortigara et al., 1999), we here prove a postnatal influence of mothering on laterality.

The influence of mothering on the laterality of chicks could be linked to social learning of the mother's behaviour (be it lateralized or not). However, as we found no correlation between mothers' and chicks' laterality, this is very unlikely. Alternatively, it could be that, in the absence of a mother, chicks learned from each other. This could explain why non-brooded chicks were more aligned. In starlings, adult deprivation leads young individuals to copy each other's songs even if they can hear live adults' songs (Poirier et al., 2004). This suggests that the absence of adults may lead young individuals to focus on and learn from each other.

The mothering effect could also be due to lateralized interactions between the mother and her young. For instance, the chicks' position under the mother during warming, a gentle or an agonistic pecking performed preferentially on one side, or a mother's preferred side to approach her chicks may have influenced chicks' laterality. In mammals with only one young at a time, the mother keeps her young in one visual hemi-field and subsequently has a preferred side to approach her young (in horses: Karenina, Giljov, & Malashichev, 2018; elephants: Karenina, Giljov, de Silva, & Malashichev, 2018 and orcas: Karenina, Giljov, Ivkovich, Burdin, & Malashichev, 2013). In our case, it could be that each chick preferred to approach or interact with its mother on one side instead of the other but that this preference varied from one chick to the other because of limited access to the mother. This could explain why brooded chicks were individually lateralized but not in the same direction.

Another possible cause of the differences between non-brooded and brooded chicks is the difference in growth. Non-brooded chicks grew faster and became heavier than brooded chicks. Such a difference has already been reported in other studies (e.g. Wauters, Richard-Yris, & Talec, 2002). A higher level of activity or more efficient pecking in brooded chicks, or an

adaptation of brooded chicks to the rhythm of their mother may explain this difference. Differences in growth could imply that both the motor and the visual systems reach maturity later in brooded chicks, which may influence laterality. We know that there is a change in the hemispheric dominance of chicks during the 12 first days of life (Lesley J. Rogers, 1991). However, studies on the maturation of visual dominance used either non-brooded chicks only (Andrew, 1988) or brooded chicks only (Workman & Andrew, 1989; Vallortigara, Andrew, Sertori, & Regolin, 1997). To date, we therefore do not know whether the motor and visual systems of non-brooded and brooded chicks mature at different speed. It would be necessary to compare directly maturation in these two types of chicks to answer this question.

In order to understand the mechanisms that are involved in the observed mothering effect, it will be necessary to study mother/young interactions. It would also be interesting to compare laterality in chicks raised by a left-lateralized mother or by a right-lateralized mother. The number of chicks is also likely to have an effect on the mother's behaviour and on the chicks' laterality and would deserve to be studied.

Mothering also had an influence on young's sociality and emotivity. Non-brooded chicks were more social and less emotional than brooded chicks. A mothering effect on sociality and emotivity has already been demonstrated, but with brooded-chicks being more social and less emotional (Perré et al., 2002; Shimmura et al., 2010). In quail, chicks' emotional reactivity is modulated by the mother's reactivity and this maternal influence remains after the end of maternal contact (Pittet, Houdelier, Le Bot, Leterrier, & Lumineau, 2014). In our experiment, it could be that daily interactions with humans (associated with the withdrawal of chicks) have stressed the mothers rather than habituated them and that this influenced chicks' emotivity and social motivation. This uncontrolled parameter may explain why non-brooded chicks were less emotional and more social than brooded chicks. Since stress can influence the expression of lateralized behaviours (e.g. Rogers, 2010), it may also explain the difference in laterality.

Other measures showed that non-brooded chicks were more social than brooded chicks: they were less scattered in the home cage and less desynchronized. Interestingly, the less scattered and the less desynchronized (therefore the more social) the chicks were, the more lateralized they were. This means that, somehow, sociality correlated with laterality. A multidimensional analysis confirmed this link between sociality and laterality. The correlation between laterality and sociality may explain how the mother, by modulating its chicks' sociality, could also modulate their laterality.

Since Vallortigara and Rogers argued for a link between social interactions and the alignment of individual biases, it is very interesting that we found that non-brooded chicks were concurrently more social, more lateralised and more aligned. Although several studies have observed a bigger prevalence of populational laterality in social than in solitary species, almost none has tried to link individuals' laterality to individuals' social propensity (Dadda, Sovrano, & Bisazza, 2003; Sovrano, Rainoldi, Bisazza, & Vallortigara, 1999). Our study is therefore the first to prove experimentally that laterality goes hand in hand with sociality, which is a prerequisite for laterality to be advantageous in social interactions (Ghirlanda et al., 2009).

We found that the more social the subjects were, the more lateralized they were. The most social group was also the most lateralized and most aligned group. These results support the hypothesis that social pressures may have played a role in the establishment of a common direction of asymmetries among the individuals of a group (Vallortigara & Rogers, 2005). We also provide evidence that mothering influences young's laterality at both the individual- and the group-level. This mothering effect may have consequences on the survival of young. Whereas non-lateralized individuals may be able to adapt more easily to changing environments (see Rogers, 2000), lateralized individuals may be able to respond more quickly to predators (Rogers et al., 2004) and to stay more grouped. Benefits of lateralisation might also vary according to the degree of sociality of young along development and after emancipation. In the

future, it will be interesting to study the complex interplay between sociality and laterality and to see how mothering, by modulating both social behaviours and laterality, may influence survival and the adaptation of offspring to more or less predictable environment.

ACKNOWLEDGEMENTS

Univ Rennes and the French CNRS provided financial support for the conduct of the research. We thank Céline Nicolle, Géraldine Moy and Valérie Adamandidis for their help with animal care. We thank David Gourichon for providing the eggs. We thank Fouad Nassur and Corentin Monmasson for their technical help. We thank Gérard Leboucher for his expert tips.

REFERENCES

- Andrew, R. J. (1988). The development of visual lateralization in the domestic chick. *Behavioural Brain Research*, 29(3), 201–209. [https://doi.org/10.1016/0166-4328\(88\)90025-3](https://doi.org/10.1016/0166-4328(88)90025-3)
- Anfora, G., Frasnelli, E., Maccagnani, B., Rogers, L. J., & Vallortigara, G. (2010). Behavioural and electrophysiological lateralization in a social (*Apis mellifera*) but not in a non-social (*Osmia cornuta*) species of bee. *Behavioural Brain Research*, 206(2), 236–239. <https://doi.org/10.1016/j.bbr.2009.09.023>
- Azemar, G. (1975). Latéralité et différenciation qualitative des conduites motrices [Laterality and the qualitative differentiation of motor activity]. *Revue de Neuropsychiatrie infantile*, 23(1), 13–21.
- Benelli, G., Donati, E., Romano, D., Stefanini, C., Messing, R. H., & Canale, A. (2015). Lateralisation of aggressive displays in a tephritid fly. *The Science of Nature*, 102, 1. <https://doi.org/10.1007/s00114-014-1251-6>
- Bertin, A., & Richard-Yris, M.-A. (2005). Mothering during early development influences subsequent emotional and social behaviour in Japanese quail. *Journal of Experimental*

- Zoology Part A: Comparative Experimental Biology*, 303A(9), 792–801.
<https://doi.org/10.1002/jez.a.202>
- Bisazza, A., Cantalupo, C., Capocchiano, M., & Vallortigara, G. (2000). Population lateralisation and social behaviour: A study with 16 species of fish. *Laterality: Asymmetries of Body, Brain and Cognition*, 5(3), 269–284.
<https://doi.org/10.1080/713754381>
- Bisazza, A., De Santi, A., Bonso, S., & Sovrano, V. A. (2002). Frogs and toads in front of a mirror: lateralisation of response to social stimuli in tadpoles of five anuran species. *Behavioural Brain Research*, 134(1–2), 417–424. [https://doi.org/10.1016/S0166-4328\(02\)00055-4](https://doi.org/10.1016/S0166-4328(02)00055-4)
- Boeving, E. R., Belnap, S. C., & Nelson, E. L. (2017). Embraces are lateralized in spider monkeys (*Ateles fusciceps rufiventris*). *American Journal of Primatology*, 79(6), e22654. <https://doi.org/10.1002/ajp.22654>
- Böye, M., Güntürkün, O., & Vauclair, J. (2005). Right ear advantage for conspecific calls in adults and subadults, but not infants, California sea lions (*Zalophus californianus*): hemispheric specialization for communication? *European Journal of Neuroscience*, 21(6), 1727–1732. <https://doi.org/10.1111/j.1460-9568.2005.04005.x>
- Broca, M. P. (1861). Remarques sur le siège de la faculté du langage articulé, suivies d'une observation d'aphémie (perte de la parole). *Bulletin et Mémoires de la Société anatomique de Paris*, 6, 330–357.
- Casey, M. B. (2005). Asymmetrical hatching behaviors: The development of postnatal motor laterality in three precocial bird species. *Developmental Psychobiology*, 47(2), 123–135.
<https://doi.org/10.1002/dev.20078>

- Casey, M. B., & Karpinski, S. (1999). The Development of Postnatal Turning Bias is Influenced by Prenatal Visual Experience in Domestic Chicks (*Gallus gallus*). *The Psychological Record*, 49(1).
- Casperd, J. M., & Dunbar, R. I. M. (1996). Asymmetries in the visual processing of emotional cues during agonistic interactions by gelada baboons. *Behavioural Processes*, 37(1), 57–65. [https://doi.org/10.1016/0376-6357\(95\)00075-5](https://doi.org/10.1016/0376-6357(95)00075-5)
- Chiandetti, C., Galliussi, J., Andrew, R. J., & Vallortigara, G. (2013). Early-light embryonic stimulation suggests a second route, via gene activation, to cerebral lateralization in vertebrates. *Scientific Reports*, 3, 2701. <https://doi.org/10.1038/srep02701>
- Chiandetti, C., & Vallortigara, G. (2019). Distinct effect of early and late embryonic light-stimulation on chicks' lateralization. *Neuroscience*, 414, 1–7. <https://doi.org/10.1016/j.neuroscience.2019.06.036>
- Collins, R. L. (1988). Observational learning of a left-right behavioral asymmetry in mice (*Mus musculus*). *Journal of Comparative Psychology*, 102(3), 222–224. <https://doi.org/10.1037/0735-7036.102.3.222>
- Dadda, M., Sovrano, V. A., & Bisazza, A. (2003). Temporal pattern of social aggregation in tadpoles and its influence on the measurement of lateralised response to social stimuli. *Physiology & Behavior*, 78(2), 337–341. [https://doi.org/10.1016/S0031-9384\(02\)01001-6](https://doi.org/10.1016/S0031-9384(02)01001-6)
- Deckel, A. W. (1995). Laterality of aggressive responses in Anolis. *Journal of Experimental Zoology*, 272(3), 194–200. <https://doi.org/10.1002/jez.1402720304>
- Deng, C., & Rogers, L. J. (2002). Social recognition and approach in the chick: lateralization and effect of visual experience. *Animal Behaviour*, 63, 697–706.

- Farmer, K., Krüger, K., Byrne, R. W., & Marr, I. (2018). Sensory laterality in affiliative interactions in domestic horses and ponies (*Equus caballus*). *Animal Cognition*, *21*(5), 631–637. <https://doi.org/10.1007/s10071-018-1196-9>
- Fernández-Carriba, S., Loeches, Á., Morcillo, A., & Hopkins, W. D. (2002). Asymmetry in facial expression of emotions by chimpanzees. *Neuropsychologia*, *40*(9), 1523–1533. [https://doi.org/10.1016/S0028-3932\(02\)00028-3](https://doi.org/10.1016/S0028-3932(02)00028-3)
- Frasnelli, E. (2017). Lateralization in Invertebrates. In: L. J. Rogers, & G. Vallortigara (Eds.), *Lateralized Brain Functions* (Neuromethods, vol 122, pp. 153–208). New York, NY: Humana Press. https://doi.org/10.1007/978-1-4939-6725-4_6
- Frasnelli, E., Haase, A., Rigosi, E., Anfora, G., Rogers, L. J., & Vallortigara, G. (2014). The Bee as a Model to Investigate Brain and Behavioural Asymmetries. *Insects*, *5*(1), 120–138. <https://doi.org/10.3390/insects5010120>
- Frasnelli, E., Vallortigara, G., & Rogers, L. J. (2012). Left–right asymmetries of behaviour and nervous system in invertebrates. *Neuroscience & Biobehavioral Reviews*, *36*(4), 1273–1291. <https://doi.org/10.1016/j.neubiorev.2012.02.006>
- Gil-da-Costa, R., & Hauser, M. D. (2006). Vervet monkeys and humans show brain asymmetries for processing conspecific vocalizations, but with opposite patterns of laterality. *Proceedings of the Royal Society B: Biological Sciences*, *273*(1599), 2313–2318. <https://doi.org/10.1098/rspb.2006.3580>
- Ghirlanda, S., Frasnelli, E., & Vallortigara, G. (2009). Intraspecific competition and coordination in the evolution of lateralization. *Philosophical Transactions of the Royal Society B: Biological Sciences*, *364*(1519), 861–866. <https://doi.org/10.1098/rstb.2008.0227>
- Ghirlanda, S., & Vallortigara, G. (2004). The evolution of brain lateralization: a game-theoretical analysis of population structure. *Proceedings of the Royal Society of London*.

Series B: Biological Sciences, 271(1541), 853–857.

<https://doi.org/10.1098/rspb.2003.2669>

Hauser, M. D., & Andersson, K. (1994). Left hemisphere dominance for processing vocalizations in adult, but not infant, rhesus monkeys: field experiments. *Proceedings of the National Academy of Sciences*, 91(9), 3946–3948. <https://doi.org/10.1073/pnas.91.9.3946>

Hauser, M. D., & Akre, K. (2001). Asymmetries in the timing of facial and vocal expressions by rhesus monkeys: implications for hemispheric specialization. *Animal Behaviour*, 61(2), 391–400. <https://doi.org/10.1006/anbe.2000.1588>

Heyes, C. M., & Dawson, G. R. (1990). A Demonstration of Observational Learning in Rats using a Bidirectional Control. *The Quarterly Journal of Experimental Psychology Section B*, 42(1b), 59–71. <https://doi.org/10.1080/14640749008401871>

Jones, R. B., Mills, A. D., & Faure, J.-M. (1991). Genetic and experiential manipulation of fear-related behavior in Japanese quail chicks (*Coturnix coturnix japonica*). *Journal of Comparative Psychology*, 105(1), 15–24. <https://doi.org/10.1037/0735-7036.105.1.15>

Karenina, K., & Giljov, A. (2018). Mother and offspring lateralized social behavior across mammalian species. In G. S. Forrester, W. D. Hopkins, K. Hudry, & A. Lindell (Eds.), *Progress in Brain Research. Cerebral lateralization and cognition: evolutionary and developmental investigations of behavioral biases* (pp. 115–141). New York, NY: Elsevier. <https://doi.org/10.1016/bs.pbr.2018.06.003>

Karenina, K., Giljov, A., de Silva, S., & Malashichev, Y. (2018). Social lateralization in wild Asian elephants: visual preferences of mothers and offspring. *Behavioral Ecology and Sociobiology*, 72(2), 21. <https://doi.org/10.1007/s00265-018-2440-7>

Karenina, K., Giljov, A., Glazov, D., & Malashichev, Y. (2013). Social laterality in wild beluga whale infants: comparisons between locations, escort conditions, and ages. *Behavioral*

- Ecology and Sociobiology*, 67(7), 1195–1204. <https://doi.org/10.1007/s00265-013-1545-2>
- Karenina, K., Giljov, A., Ivkovich, T., Burdin, A., & Malashichev, Y. (2013). Lateralization of spatial relationships between wild mother and infant orcas, *Orcinus orca*. *Animal Behaviour*, 86(6), 1225–1231. <https://doi.org/10.1016/j.anbehav.2013.09.025>
- Karenina, K., Giljov, A., & Malashichev, Y. (2018). Lateralization of mother-infant interactions in wild horses. *Behavioural Processes*, 148, 49–55. <https://doi.org/10.1016/j.beproc.2018.01.010>
- Lemasson, A., Koda, H., Kato, A., Oyakawa, C., Blois-Heulin, C., & Masataka, N. (2010). Influence of sound specificity and familiarity on Japanese macaques' (*Macaca fuscata*) auditory laterality. *Behavioural Brain Research*, 208(1), 286–289. <https://doi.org/10.1016/j.bbr.2009.12.008>
- Mascetti, G. G., & Vallortigara, G. (2001). Why do birds sleep with one eye open? Light exposure of the chick embryo as a determinant of monocular sleep. *Current Biology*, 11(12), 971–974. [https://doi.org/10.1016/S0960-9822\(01\)00265-2](https://doi.org/10.1016/S0960-9822(01)00265-2)
- Meguerditchian, A., Molesti, S., & Vauclair, J. (2011). Right-handedness predominance in 162 baboons (*Papio anubis*) for gestural communication: Consistency across time and groups. *Behavioral Neuroscience*, 125(4), 653–660. <https://doi.org/10.1037/a0023823>
- Miklósi, A. (1996). Auditory Lateralisation: Shifts in Ear Use During Attachment in the Domestic Chick. *Laterality: Asymmetries of Body, Brain and Cognition*, 1(3), 215–224. <https://doi.org/10.1080/713754242>
- Perré, Y., Wauters, A.-M., & Richard-Yris, M.-A. (2002). Influence of mothering on emotional and social reactivity of domestic pullets. *Applied Animal Behaviour Science*, 75(2), 133–146. [https://doi.org/10.1016/S0168-1591\(01\)00189-7](https://doi.org/10.1016/S0168-1591(01)00189-7)

- Pittet, F., Houdelier, C., Le Bot, O., Leterrier, C., & Lumineau, S. (2014). Fearfulness Affects Quail Maternal Care and Subsequent Offspring Development. *PLoS ONE*, *9*(7), e102800. <https://doi.org/10.1371/journal.pone.0102800>
- Poirier, C., Henry, L., Mathelier, M., Lumineau, S., Cousillas, H., & Hausberger, M. (2004). Direct Social Contacts Override Auditory Information in the Song-Learning Process in Starlings (*Sturnus vulgaris*). *Journal of Comparative Psychology*, *118*(2), 179–193. <https://doi.org/10.1037/0735-7036.118.2.179>
- Prieur, J., Pika, S., Barbu, S., & Blois-Heulin, C. (2018). A multifactorial investigation of captive gorillas' intraspecific gestural laterality. *Laterality: Asymmetries of Body, Brain and Cognition*, *23*(5), 538–575. <https://doi.org/10.1080/1357650X.2017.1410167>
- Quaresmini, C., Forrester, G. S., Spiezio, C., & Vallortigara, G. (2014). Social environment elicits lateralized behaviors in gorillas (*Gorilla gorilla gorilla*) and chimpanzees (*Pan troglodytes*). *Journal of Comparative Psychology*, *128*(3), 276–284. <https://doi.org/10.1037/a0036355>
- R Core Team. (2014). *R: A language and environment for statistical computing* [R]. Retrieved from <http://www.R-project.org/>
- Regolin, L., Vallortigara, G., & Zanforlin, M. (1994). Perceptual and motivational aspects of detour behaviour in young chicks. *Animal Behaviour*, *47*(1), 123–131. <https://doi.org/10.1006/anbe.1994.1014>
- Reinholz-Trojan, A., Włodarczyk, E., Trojan, M., Kulczyński, A., & Stefańska, J. (2012). Hemispheric specialization in domestic dogs (*Canis familiaris*) for processing different types of acoustic stimuli. *Behavioural Processes*, *91*(2), 202–205. <https://doi.org/10.1016/j.beproc.2012.07.001>

- Richard-Yris, M. A., & Leboucher, G. (1987a). Effects of exposure to chicks on maternal behaviour in domestic chickens. *Bird Behavior*, 7(1), 31–36.
<https://doi.org/10.3727/015613887791918150>
- Richard-Yris, M.-A., Leboucher, G., Chadwick, A., & Garnier, D. H. (1987b). Induction of maternal behavior in incubating and non-incubating hens: Influence of hormones. *Physiology & Behavior*, 40(2), 193–199. [https://doi.org/10.1016/0031-9384\(87\)90207-1](https://doi.org/10.1016/0031-9384(87)90207-1)
- Robins, A., Lippolis, G., Bisazza, A., Vallortigara, G., & Rogers, L. J. (1998). Lateralized agonistic responses and hindlimb use in toads. *Animal Behaviour*, 56(4), 875–881.
<https://doi.org/10.1006/anbe.1998.0877>
- Rogers, L. J. (1991). Development of lateralisation. In R. J. Andrew (Ed.), *Neural and Behavioural Plasticity: The Use of the Domestic Chick as a Model* (pp. 507–535). Oxford, UK: Oxford University Press.
DOI:10.1093/acprof:oso/9780198521846.003.0021
- Rogers, L. J. (2000). Evolution of Hemispheric Specialization: Advantages and Disadvantages. *Brain and Language*, 73(2), 236–253. <https://doi.org/10.1006/brln.2000.2305>
- Rogers, L. J. (2010). Relevance of brain and behavioural lateralization to animal welfare. *Applied Animal Behaviour Science*, 127(1–2), 1–11.
<https://doi.org/10.1016/j.applanim.2010.06.008>
- Rogers, L. J., & Andrew, R. J. (2002). Introduction. In L. J. Rogers, & R. J. Andrew (Eds.), *Comparative Vertebrate Lateralization* (pp. 1–8). Cambridge, UK: Cambridge University Press.
- Rogers, L.J., & Bolden, S. W. (1991). Light-dependent development and asymmetry of visual projections. *Neuroscience Letters*, 121(1–2), 63–67.

- Rogers, L. J., Frasnelli, E., & Versace, E. (2016). Lateralized antennal control of aggression and sex differences in red mason bees, *Osmia bicornis*. *Scientific Reports*, 6, 29411. <https://doi.org/10.1038/srep29411>
- Rogers, L. J., Rigosi, E., Frasnelli, E., & Vallortigara, G. (2013). A right antenna for social behaviour in honeybees. *Scientific Reports*, 3, 2045. <https://doi.org/10.1038/srep02045>
- Rogers, L. J., & Vallortigara, G. (2015). When and Why Did Brains Break Symmetry? *Symmetry*, 7(4), 2181–2194. <https://doi.org/10.3390/sym7042181>
- Rogers, L. J., Vallortigara, G., & Andrew, R. J. (2013). *Divided brains: The biology and behaviour of brain asymmetries*. New York, NY: Cambridge University Press. <https://doi.org/10.1017/CBO9780511793899>
- Rogers, L. J., Zucca, P., & Vallortigara, G. (2004). Advantages of having a lateralized brain. *Proceedings of the Royal Society of London. Series B: Biological Sciences*, 271(Suppl 6), S420-S422. <https://doi.org/10.1098/rsbl.2004.0200>
- Rosa Salva, O., Regolin, L., Mascalon, E., & Vallortigara, G. (2012). Cerebral and behavioural asymmetries in animal social recognition. *Comparative Cognition & Behavior Reviews*, 7, 110–138. <https://doi.org/10.3819/ccbr.2012.70006>
- Sakai, M., Hishii, T., Takeda, S., & Kohshima, S. (2006). Laterality of flipper rubbing behaviour in wild bottlenose dolphins (*Tursiops aduncus*): Caused by asymmetry of eye use? *Behavioural Brain Research*, 170(2), 204–210. <https://doi.org/10.1016/j.bbr.2006.02.018>
- Schnell, A. K., Bellanger, C., Vallortigara, G., & Jozet-Alves, C. (2018). Visual asymmetries in cuttlefish during brightness matching for camouflage. *Current Biology*, 28(17), R925–R926. <https://doi.org/10.1016/j.cub.2018.07.019>
- Schnell A. K., Jozet-Alves C., Hall K. C., Radday L., & Hanlon R. T. (2019). Fighting and mating success in giant Australian cuttlefish is influenced by behavioural lateralization.

- Proceedings of the Royal Society B: Biological Sciences*, 286(1898), 20182507.
<https://doi.org/10.1098/rspb.2018.2507>
- Shimmura, T., Kamimura, E., Azuma, T., Kansaku, N., Uetake, K., & Tanaka, T. (2010). Effect of broody hens on behaviour of chicks. *Applied Animal Behaviour Science*, 126(3–4), 125–133. <https://doi.org/10.1016/j.applanim.2010.06.011>
- Soulé, M. (1967). Phenetics of Natural Populations. II. Asymmetry and Evolution in a Lizard. *The American Naturalist*, 101(918), 141–160. <https://doi.org/10.1086/282480>
- Sovrano, V. A., Rainoldi, C., Bisazza, A., & Vallortigara, G. (1999). Roots of brain specializations: preferential left-eye use during mirror-image inspection in six species of teleost fish. *Behavioural Brain Research*, 106(1), 175–180. [https://doi.org/10.1016/S0166-4328\(99\)00105-9](https://doi.org/10.1016/S0166-4328(99)00105-9)
- Sovrano, V. A., Bisazza, A., & Vallortigara, G. (2001). Lateralization of response to social stimuli in fishes: A comparison between different methods and species. *Physiology & Behavior*, 74(1–2), 237–244. [https://doi.org/10.1016/S0031-9384\(01\)00552-2](https://doi.org/10.1016/S0031-9384(01)00552-2)
- Suarez, S. D., & Gallup, G. G. (1983). Social reinstatement and open-field testing in chickens. *Animal Learning & Behavior*, 11(1), 119–126. <https://doi.org/10.3758/BF03212318>
- Tommasi, L., & Vallortigara, G. (1999). Footedness in Binocular and Monocular Chicks. *Laterality: Asymmetries of Body, Brain and Cognition*, 4(1), 89–95. <https://doi.org/10.1080/713754325>
- Vallortigara, G. (1992). Affiliation and aggression as related to gender in domestic chicks (*Gallus gallus*). *Journal of Comparative Psychology*, 106(1), 53–57. <https://doi.org/10.1037/0735-7036.106.1.53>
- Vallortigara, G. (2000). Comparative neuropsychology of the dual brain: a stroll through animals' left and right perceptual worlds. *Brain and Language*, 73(2), 189–219.

- Vallortigara, G. (2006). The evolutionary psychology of left and right: Costs and benefits of lateralization. *Developmental Psychobiology*, 48(6), 418–427. <https://doi.org/10.1002/dev.20166>
- Vallortigara, G., & Andrew, R. J. (1994). Olfactory lateralization in the chick. *Neuropsychologia*, 32(4), 417–423. [https://doi.org/10.1016/0028-3932\(94\)90087-6](https://doi.org/10.1016/0028-3932(94)90087-6)
- Vallortigara, G., Andrew, R. J., Sertori, L., & Regolin, L. (1997). Sharply Timed Behavioral Changes During the First 5 Weeks of Life in the Domestic Chick (*Gallus gallus*). *Bird Behavior*, 12(1), 29–40. <https://doi.org/10.3727/015613897797141290>
- Vallortigara, G., Cailotto, M., & Zanforlin, M. (1990). Sex differences in social reinstatement motivation of the domestic chick (*Gallus gallus*) revealed by runway tests with social and nonsocial reinforcement. *Journal of Comparative Psychology*, 104(4), 361–367. <https://doi.org/10.1037/0735-7036.104.4.361>
- Vallortigara, G., Cozzutti, C., Tommasi, L., & Rogers, L. J. (2001). How birds use their eyes: Opposite left-right specialization for the lateral and frontal visual hemifield in the domestic chick. *Current Biology*, 11(1), 29–33. [https://doi.org/10.1016/S0960-9822\(00\)00027-0](https://doi.org/10.1016/S0960-9822(00)00027-0)
- Vallortigara, G., Regolin, L., & Pagni, P. (1999). Detour behaviour, imprinting and visual lateralization in the domestic chick. *Cognitive Brain Research*, 7(3), 307–320. [https://doi.org/10.1016/S0926-6410\(98\)00033-0](https://doi.org/10.1016/S0926-6410(98)00033-0)
- Vallortigara, G., & Rogers, L. J. (2005). Survival with an asymmetrical brain: Advantages and disadvantages of cerebral lateralization. *Behavioral and Brain Sciences*, 28(4), 575–633. <https://doi.org/10.1017/S0140525X05000105>
- Vallortigara, G., Rogers, L. J., Bisazza, A., Lippolis, G., & Robins, A. (1998). Complementary right and left hemifield use for predatory and agonistic behaviour in toads. *NeuroReport*, 9(14), 3341.

- Vallortigara, G., & Versace, E. (2017). Laterality at the neural, cognitive, and behavioral levels. In J. Call, G. M. Burghardt, I. M. Pepperberg, C. T. Snowdon, & T. Zentall (Eds.), *APA handbooks in psychology. APA handbook of comparative psychology: Basic concepts, methods, neural substrate, and behavior* (pp. 557-577). Washington, DC: American Psychological Association. <http://dx.doi.org/10.1037/0000011-027>
- Versace, E., Morgante, M., Pulina, G., & Vallortigara, G. (2007). Behavioural lateralization in sheep (*Ovis aries*). *Behavioural Brain Research*, 184(1), 72–80. <https://doi.org/10.1016/j.bbr.2007.06.016>
- Wauters, A.-M., Richard-Yris, M.-A., & Talec, N. (2002). Maternal Influences on Feeding and General Activity in Domestic Chicks. *Ethology*, 108(6), 529–540. <https://doi.org/10.1046/j.1439-0310.2002.00793.x>
- Workman, L., & Andrew, R. J. (1989). Simultaneous changes in behaviour and in lateralization during the development of male and female domestic chicks. *Animal Behaviour*, 38(4), 596–605. [https://doi.org/10.1016/S0003-3472\(89\)80004-1](https://doi.org/10.1016/S0003-3472(89)80004-1)
- Zucca, P., & Sovrano, V. A. (2008). Animal lateralization and social recognition: Quails use their left visual hemifield when approaching a companion and their right visual hemifield when approaching a stranger. *Cortex*, 44(1), 13–20. <https://doi.org/10.1016/j.cortex.2006.01.002>

Table 1: Mean ($X \pm SE$) weights (g) of non-brooded (NB) and brooded (B) chicks during development (from d1 to d29: N_{NB} : 21, N_B : 21; from d36 to d50: N_{NB} :21, N_B : 20).

	NB	B
d1	37.9+3.4	37.1+3.2
d8	59.9+9.1	52.5+6.2
d15	116.4+13.1	102.1+15.2
d22	202.4+25.9	165.1+25.4
d29	303.5+44.9	236.1+44.1
d36	430.3+64.7	339.5+59.1
d43	564.7+77.6	452.2+76.2
d50	656.4+95.5	554.3+99.7

Table 2: Number of individually lateralised non-brooded (NB) and brooded (B) chicks in the T-maze test (N_{NB} : 9 ♀, 11 ♂; N_B : 13 ♀, 7 ♂) and in the detour test (N_{NB} : 9 ♀, 11 ♂; N_B : 10 ♀, 7 ♂).

	Laterality	Sex	NB	B
T-MAZE	Left	♀	1	0
	Left	♂	1	0
	Right	♀	5	2
	Right	♂	1	0
DETOUR	Left	♀	0	1
	Left	♂	0	3
	Right	♀	2	1
	Right	♂	4	1

Table 3: Number of non-brooded (NB) and brooded (B) chicks choosing the left or the right side in the first T-maze session (N_{NB} : 9 ♀, 11 ♂; N_B : 14 ♀, 7 ♂) and in the first detour test session (N_{NB} : 9 ♀, 11 ♂; N_B : 13 ♀, 7 ♂).

	CHOICE	NB	B
T-MAZE	Left	9	11
	Right	11	9
DETOUR	Left	3	13
	Right	17	7

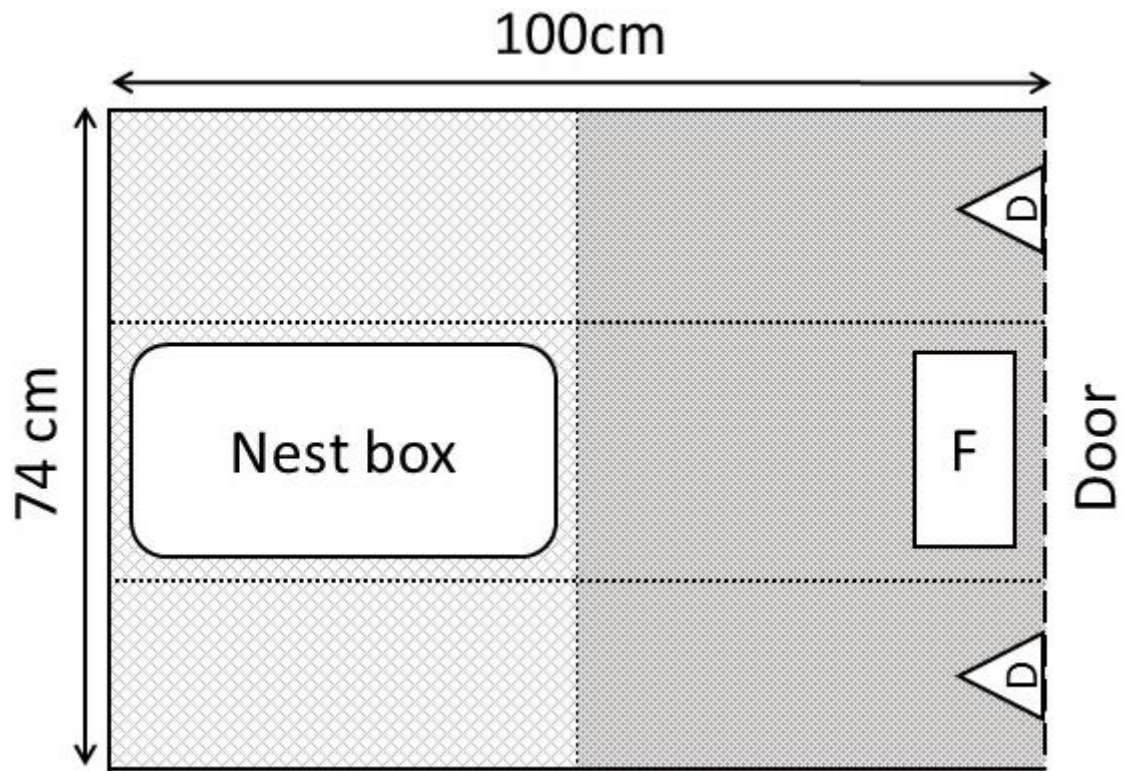



Figure 1: Individual home cage (dotted lines separate six virtual sections). F: feeding trough, D: drinking trough,  : artificial turf.

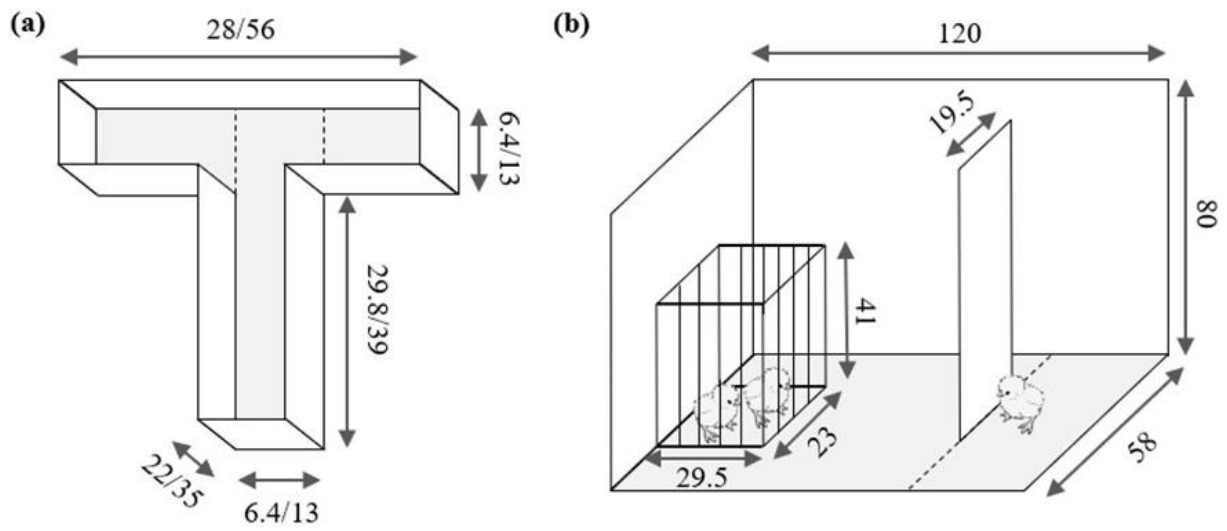

Figure 2: Experimental setup for chicks' laterality assessment (dimensions are given in cm):
 (a) T-maze (dimensions: small apparatus/large apparatus) and (b) detour test. Dotted lines:
 lines chicks had to cross with both feet to make a choice.

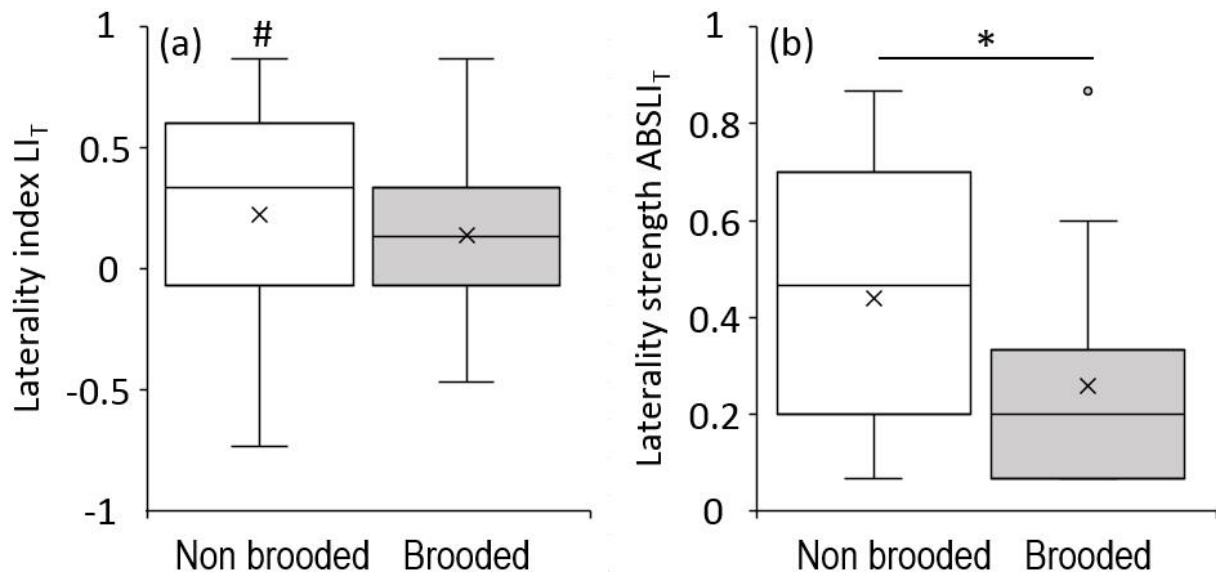

Figure 3: (a) Laterality index (LI_T) and (b) laterality strength ($ABSLI_T$) in the T-maze (N_{NB} : 9 ♀, 11 ♂; N_B : 13 ♀, 7 ♂). Boxplots: cross = average, centre bar = median, lower side = 1st quartile, upper side = 3rd quartile, whiskers = minimum and maximum values, point = out of standard values. Welsh t test: # $0.01 \leq P < 0.05$; ANOVA: * $0.01 \leq P < 0.05$.

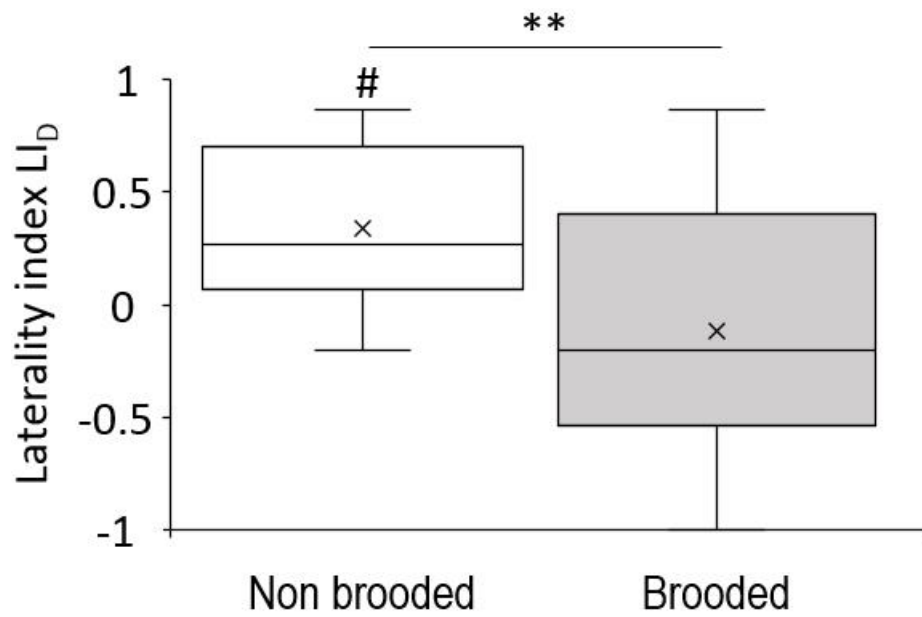

Figure 4: Laterality index (LI_D) calculated from detour test choices (N_{NB} : 9 ♀, 11 ♂; N_B : 10 ♀, 7 ♂). Boxplots: cross = average, center bar = median, lower side = 1st quartile, upper side = 3rd quartile, whiskers = minimum and maximum values. Welsh t test: # $0.01 \leq P < 0.05$; ANOVA: $**0.001 \leq P < 0.01$.

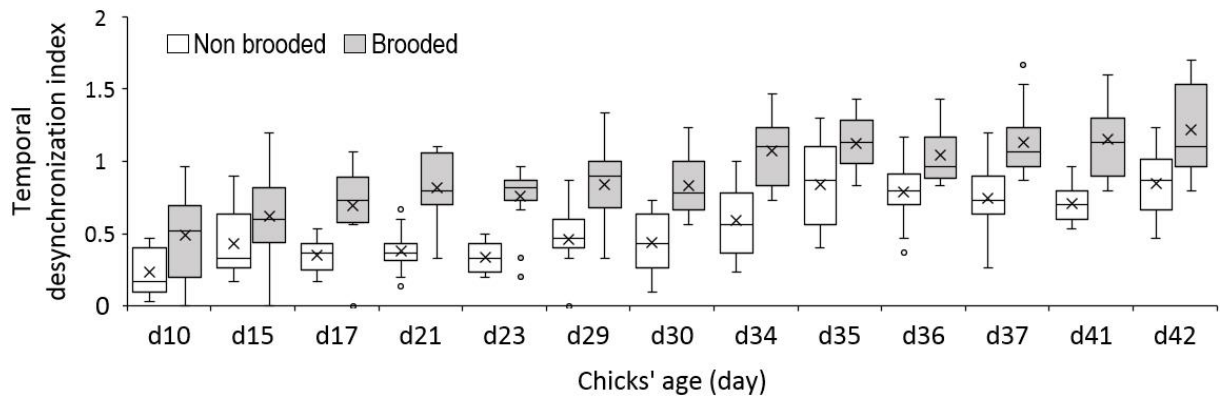

Figure 5: Chicks' index of temporal desynchronization (T_C) as a function of age (from d10 to d30: N_{NB} : 21, N_B : 20; from d34 to d42: N_{NB} : 21, N_B : 17). The higher the index is, the more desynchronized the chicks are. Boxplots: cross = average, center bar = median, lower side = 1st quartile, upper side = 3rd quartile, whiskers = minimum and maximum values, points = out of standard values.

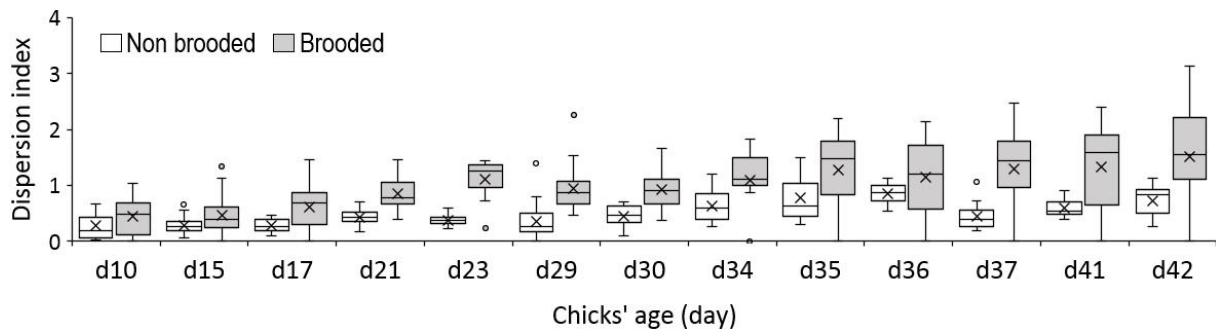

Figure 6: Chicks' index of dispersion (S_C) as a function of age (from d10 to d30: N_{NB} : 21, N_B : 20; from d34 to d42: N_{NB} : 21, N_B : 17). The higher the index is, the more scattered the chicks are. Boxplots: cross = average, center bar = median, lower side = 1st quartile, upper side = 3rd quartile, whiskers = minimum and maximum values, points = out of standard values.



Figure 7: (a) First distress call latency and (b) number of distress calls before opening the habituation box during the emergence test (N_{NB} : 9 ♀, 12 ♂; N_B : 10 ♀, 7 ♂). Boxplots: cross = average, center bar = median, lower side = 1st quartile, upper side = 3rd quartile, whiskers = minimum and maximum values, point = out of standard value. Tukey HSD tests: $*0.01 \leq P < 0.05$; $***P \leq 0.001$.

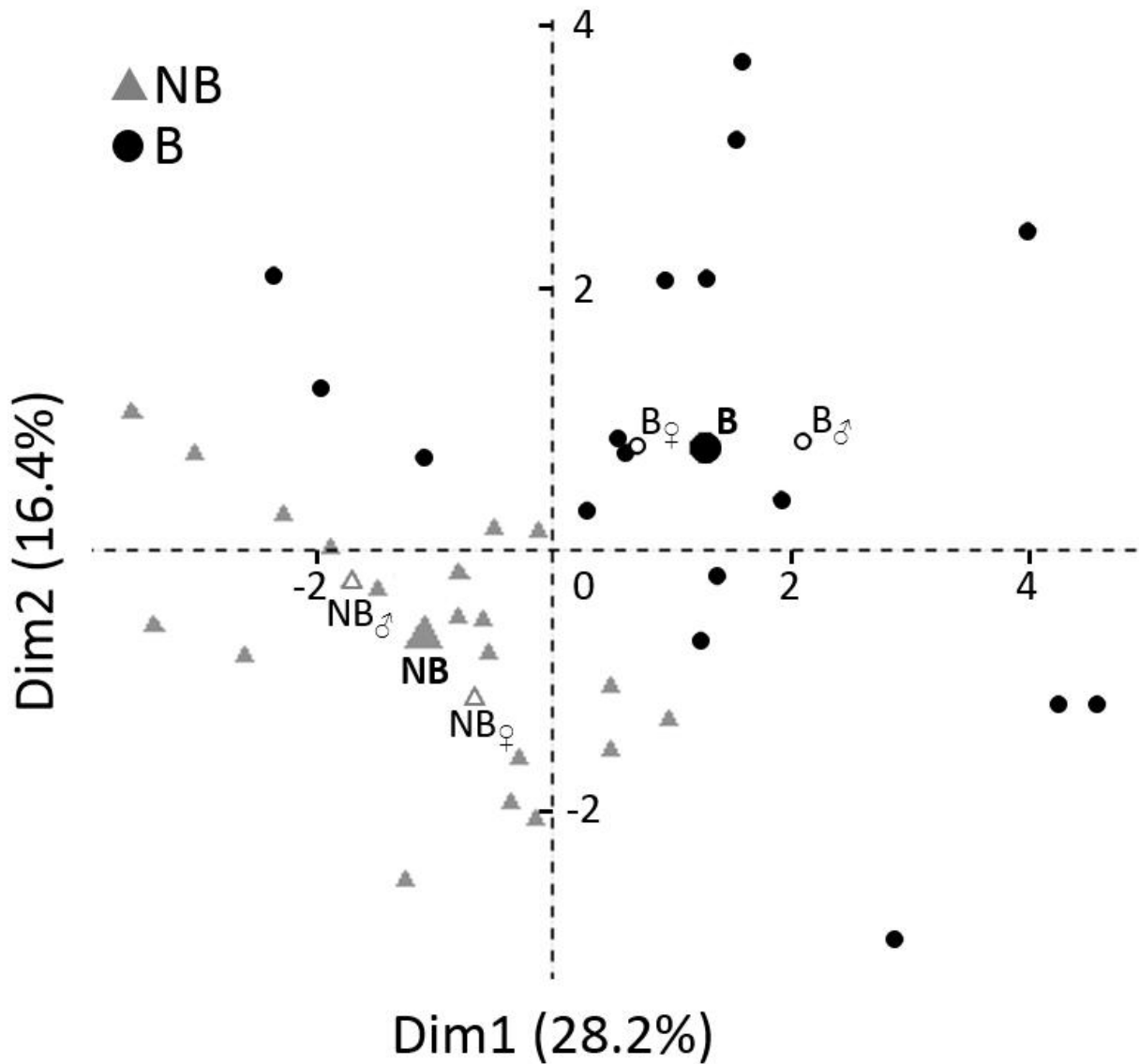

Figure 8: Representation of the subjects (filled small symbols) on the PCA's first and the second components (N_{NB} : 9 ♀, 11 ♂, N_B : 10 ♀, 7 ♂). Illustrative individuals (barycentre of concerned individuals): NB = non-brooded group (filled big symbol), NB ♀ = non-brooded ♀ (open small symbol), NB ♂ = non-brooded ♂ (open small symbol); B = brooded group (filled big symbol), B ♀ = brooded ♀ (open small symbol), M ♂ = brooded ♂ (open small symbol).