



HAL
open science

Genome editing reveals reproductive and developmental dependencies on specific types of vitellogenin in zebrafish (*Danio rerio*)

Ozlem Yilmaz, Amélie Patinote, Thuy Thao Vi Nguyen, Emmanuelle Com, Charles Pineau, Julien Bobe

► To cite this version:

Ozlem Yilmaz, Amélie Patinote, Thuy Thao Vi Nguyen, Emmanuelle Com, Charles Pineau, et al.. Genome editing reveals reproductive and developmental dependencies on specific types of vitellogenin in zebrafish (*Danio rerio*). *Molecular Reproduction and Development*, 2019, 86 (9), pp.1168-1188. <10.1002/mrd.23231>. <hal-02278084>

HAL Id: hal-02278084

<https://univ-rennes.hal.science/hal-02278084v1>

Submitted on 18 Nov 2019

HAL is a multi-disciplinary open access archive for the deposit and dissemination of scientific research documents, whether they are published or not. The documents may come from teaching and research institutions in France or abroad, or from public or private research centers.

L'archive ouverte pluridisciplinaire HAL, est destinée au dépôt et à la diffusion de documents scientifiques de niveau recherche, publiés ou non, émanant des établissements d'enseignement et de recherche français ou étrangers, des laboratoires publics ou privés.



HAL Authorization

1 **Title: Genome editing reveals reproductive and developmental dependencies on specific types of**
2 **vitellogenin in zebrafish (*Danio rerio*)**

3

4 Ozlem Yilmaz^{1,3*}, Amelie Patinote¹, Thaovi Nguyen¹, Emmanuelle Com², Charles Pineau², Julien Bobe¹.

5

6 ¹INRA, UR1037, Laboratory of Fish Physiology and Genomics, Campus de Beaulieu, 35042 Rennes
7 Cedex, France.

8 ²Protim, Inserm U1085, Irset, Campus de Beaulieu, 35042 Rennes Cedex, France.

9 ³Present address: Institute of Marine Research, Austevoll Research Station, 5392, Storebø, Norway

10 ozlem.yilmaz@hi.no.

11

12 **ABSTRACT**

13 Oviparous vertebrates produce multiple forms of vitellogenin (Vtg), the major source of yolk
14 nutrients, but little is known about their individual contributions to reproduction and development. This
15 study utilized CRISPR/Cas9 genome editing to assess essentiality and functionality of zebrafish (*Danio*
16 *rerio*) type-I and -III Vtgs. A multiple CRISPR approach was employed to knock out (KO) all genes
17 encoding type-I *vtgs* (*vtg1*, 4, 5, 6, and 7) simultaneously (*vtg1*-KO), and the type-III *vtg* (*vtg3*)
18 individually (*vtg3*-KO). Results of PCR genotyping and sequencing, qPCR, LC-MS/MS and Western
19 blotting showed that only *vtg6* and *vtg7* escaped Cas9 editing. In fish whose remaining type-I *vtgs* were
20 incapacitated (*vtg1*-KO), and in *vtg3*-KO fish, significant increases in Vtg7 transcript and protein levels
21 occurred in liver and eggs, revealing a heretofore-unknown mechanism of genetic compensation
22 regulating Vtg homeostasis. Egg numbers per spawn were elevated >2-fold in *vtg1*-KO females, and egg
23 fertility was ~halved in *vtg3*-KO females. Substantial mortality was evident in *vtg3*-KO eggs/embryos
24 after only 8h of incubation and in *vtg1*-KO embryos after 5d. Hatching rate and timing were markedly
25 impaired in embryos from *vtg* mutant mothers and pericardial and yolk sac/abdominal edema and spinal
26 lordosis were evident in the larvae, with feeding and motor activities also being absent in *vtg1*-KO larvae.

27 By late larval stages, *vtg* mutations were either completely lethal (*vtg1*-KO) or nearly so (*vtg3*-KO).
28 These novel findings offer the first experimental evidence that different types of vertebrate Vtg are
29 essential and have disparate requisite functions at different times during both reproduction and
30 development.

31

32 Keywords; *CRISPR/Cas9*, *knock out*, *vitellogenins*, *zebrafish*

33

34 1. INTRODUCTION

35 In oviparous animals, maternally supplied vitellogenins (Vtgs) are the major source of yolk
36 nutrients supporting early development. Vertebrate Vtgs are specialized members of a superfamily of
37 large lipid transfer proteins that are preferentially produced by the liver and transported via the
38 bloodstream to the ovary (Babin et al., 2007). The Vtgs are taken up into growing oocytes via receptor-
39 mediated endocytosis (Opresko and Wiley, 1987), where they are processed by the lysosomal
40 endopeptidase, cathepsin D, into product yolk proteins that are stored in the ooplasm (Carnevali et al.,
41 1999a,b, 2006). Jawed vertebrates produce three major forms of Vtg arising from a *vtg* gene cluster that
42 was present in the ancestor of tetrapods and ray-finned fish (Babin, 2008; Finn et al., 2009). During
43 vertebrate evolution these ancestral *vtg* genes were subject to whole genome duplications, loss of paralogs
44 and lineage-specific tandem duplications, giving rise to substantial variation in the repertoire and number
45 of *vtg* genes present in an individual species, especially among teleost fish (Andersen et al., 2017). The
46 linear yolk protein domain structure of complete teleost Vtgs is: NH₂-lipovitellin heavy chain (LvH)-
47 phosvitin (Pv)-lipovitellin light chain (LvL)-beta component (β' c)-C-terminal component (Ct)-COOH
48 (Patiño and Sullivan, 2002; Hiramatsu et al., 2005). Most teleosts possess from two to several forms of A-
49 type Vtg (VtgA), which may be complete or incomplete, as well an incomplete C-type Vtg (VtgC)
50 lacking both Pv and the two small C-terminal yolk protein domains (β' c and Ct). For example, the
51 complex zebrafish (*Danio rerio*) Vtg repertoire includes five type-I Vtgs (Vtg 1, 4, 5, 6 and 7) that are

52 incomplete, lacking β' -c and Ct domains (=ostariophysan VtgAo1), two type-II Vtgs (Vtg2 and Vtg8) that
53 are complete (=VtgAo2), and one type-III Vtg (Vtg3), which is a typical VtgC (Yilmaz et al., 2018).

54 The multiplicity of teleost Vtgs and the roles that different types of Vtg play in oocyte growth and
55 maturation and in embryonic and larval development have been targets of attention for decades
56 (Hiramatsu et al., 2005; Reading and Sullivan, 2011; Sullivan and Yilmaz, 2018). The most diverse group
57 of fishes, the spiny-rayed teleosts (Acanthomorpha) generally possess two paralogous complete forms of
58 VtgA (VtgAa, and VtgAb) in addition to VtgC, and these are orthologs of the zebrafish type-I, type-II and
59 type-III Vtgs, respectively (Finn et al., 2009). In some marine species spawning pelagic eggs, the VtgAa
60 has become neofunctionalized so that its product yolk proteins are highly susceptible to proteolytic
61 degradation by cathepsins during oocyte maturation, yielding a pool of free amino acids (FAA) that
62 osmotically assist oocyte hydration and acquisition of proper egg buoyancy (Matsubara et al., 1999; Finn
63 and Kristoffersen, 2007) and that also serve as critical nutrients during early embryogenesis (Thorsen and
64 Fyhn, 1996; Finn and Fyhn, 2010). The major yolk protein derived from the corresponding VtgAb
65 (LvHAb) is less susceptible to maturational proteolysis. Based on its limited degradation during oocyte
66 growth and maturation, and its utilization late in larval life in some species, it has been proposed that the
67 VtgC may be specialized to deliver large lipoprotein nutrients to late stage larvae without affecting the
68 osmotically active FAA pool (Reading et al., 2009; Reading and Sullivan, 2011). Aside from these few
69 examples, very little is known about specific contributions of the different types of Vtg to developmental
70 processes in acanthomorphs, virtually nothing is known about specialized functions of individual types of
71 Vtg in other vertebrates, and no individual form of Vtg has been proven to be required for the
72 developmental competence of eggs or offspring.

73 The zebrafish has become an established biomedical model for research on reproduction and
74 developmental biology because they are small, easily bred in the laboratory with short generation time,
75 and lay clutches of numerous large eggs every few days, with external fertilization of the transparent eggs
76 in which embryonic development is easily observed (Ribas and Piferrer, 2013). A reference genome
77 sequence is available, providing the needed databases and bioinformatics tools to conduct genomic and

78 proteomic research on Vtgs in this species. Details on the genomic and protein domain structure of each
79 individual zebrafish Vtg and on their transcript expression and protein abundance profiles were recently
80 made available by Yilmaz et al. (2018). Coupled with these advantages, the presence of multiple genes
81 encoding the three classical major types of Vtg in zebrafish offers a unique opportunity to investigate
82 their essentiality and functionality via application of CRISPR/Cas9 (clustered regularly interspaced short
83 palindromic repeats (CRISPR)/CRISPR-associated protein 9) technology (Doudna and Charpentier,
84 2014), a powerful gene-editing tool that provides a reliable process for making precise, targeted changes
85 to the genome of living cells.

86 In any given species we would like to know which forms of Vtg are essential, at what specific
87 time(s) during development they may be required, and what specific functions they may perform. This
88 study was conducted to address these questions employing zebrafish as the model species. The extensive
89 multiplicity of genes encoding type-I Vtgs, the major contributors to yolk proteins in zebrafish eggs, and
90 the high degree of sequence identity among these genes are matters of interest, especially considering
91 their lack of β' c and Ct domains, which contain 14 highly conserved cysteine residues known to engage
92 in disulfide linkages required for complex folding of the Vtg polypeptide and possibly for the
93 dimerization of native Vtg thought to be required for binding to its oocyte receptor (Reading et al., 2009;
94 Reading and Sullivan 2011). Additionally, the type-III Vtg (VtgC), lacking all but Lv domains and
95 usually being the least abundant form of Vtg, but one universally present in teleosts, begs investigation
96 regarding its contributions to early development.

97 The main objectives of this study were to discover whether type-I Vtgs and/or type-III Vtg
98 (VtgC) are required for zebrafish reproduction, and to identify specific developmental periods and
99 processes to which they significantly contribute, by investigating the effects of knock out (KO) of their
100 respective genes using the CRISPR/Cas9 gene-editing tool. In this context, KO refers to the process of
101 rendering genes incapable of producing mRNA transcripts or their respective functional proteins. The
102 high sequence identity among zebrafish type-I *vtgs* precluded single-gene loss of function studies and
103 compelled us to employ a gene family editing design, which is now common practice in CRISPR/Cas9

104 experiments (cf Hyams et al. 2018). This approach is based upon utilization of pooled sets of guide RNAs
105 expected to target most or all gene family members. In this study, we sought to individually but
106 simultaneously incapacitate all genes encoding type-I *vtgs* (*vtg1*, 4, 5, 6, and 7) by employing three target
107 sites common to all five genes, and to also incapacitate *vtg3* by employing three gene-specific targets.

108

109

110 2. RESULTS

111 The syntenic organization of *vtg* genes in the zebrafish genome is illustrated in **Fig 1**, along with
112 the general strategy employed in the present study for CRISPR target design to KO the respective type-I
113 and type-III *vtg* genes. Large deletion mutations of 1281 bp and 1181 bp of gDNA were introduced in
114 zebrafish type-I *vtgs* (*vtg1*-KO) and in *vtg3* (*vtg3*-KO), respectively, via CRISPR/Cas9 genome editing
115 (**S1 Fig A-B**). The 1181 bp deletion in *vtg3* was closely matched in size and position to the sequence
116 between two of the three single guide (sg) RNAs (sg32 and sg33). However, the 1281 bp deletion in
117 *vtg1*, which overlapped sg12, was much smaller than would result from a perfect excision between sg11
118 and sg13 (**S1 Fig A**).

119 The genomic deletion leads to a loss of 703 bp and 714 bp within the respective *vtg1* and *vtg3*
120 mRNA transcripts (**S1 Fig C-D**; see **S1 Fig E-F** for cDNAs). The deletion mutation created in the *vtg1*-
121 KO study involves a frameshift that, after 10 additional residues, leads to a premature stop codon, which
122 would terminate the polypeptide at residue 529 so that it includes only the forward half of the LvH
123 domain (**Fig 2A**; see also **S2 Fig A**), eliminating the remaining part of the LvH domain as well as the Pv
124 and LvL domains of Vtg1 (see also **S1 Fig G**). The deletion created in the *vtg3*-KO study results in
125 mutation of residue 239 from arginine (R) to leucine (L), with a clean (in-frame) deletion of the following
126 238 aa located at the end of the critical Vtg receptor-binding domain of LvH3 (**Fig 2B**; see also **S2 Fig B**)
127 that does not otherwise alter the Vtg3 polypeptide (see also **S1 Fig H**). The introduced mutations were
128 subjected to PCR screening (of gDNA) to genotype each zebrafish generation using combinations of

129 primers flanking the altered target sites (**Fig 3**). F0 generation individuals exhibiting a heterozygous
130 mutant double banding pattern were retained as founders for production of stable mutant lines (**Fig 3**).

131 Microinjection efficiency was 20% and 80% positive as determined in embryos at 24h screening,
132 for *vtg1*-KO and *vtg3*-KO, respectively. This efficiency was confirmed by finclip genotyping when
133 siblings of these embryos reached adulthood. However, mutation transmission to F1 offspring was as low
134 as 0.010% for *vtg1*-KO and 0.025% for *vtg3*-KO, and only 2 heterozygous (Ht: *vtg1*-/+ and *vtg3*-/+) adult
135 males were available to continue reproductive crosses with non-related wild type (Wt: *vtg1*+/+ and
136 *vtg3*+/+) females for production of F2 generations. The rate of mutation transmission to the F2 generation
137 produced from F1 Ht males and Wt females was 55% and 70% for *vtg1*-KO and *vtg3*-KO, respectively.
138 Reproductive crosses of Ht males and Ht females revealed a Mendelian inheritance pattern with 25% wild
139 type (wt: sibling wild type; *vtg1*+/+ and *vtg3*+/+), 52% heterozygous and 22% homozygous (Hm: *vtg1*-/
140 and *vtg3*-/-) individuals at the F3 generation. Hm F3 females and males were crossed to produce the F4
141 generation yielding 100% homozygous offspring carrying only the mutated allele (**Fig 3**). As these Hm
142 individuals are generally inviable (*see below*), production of subsequent generations of mutants requires
143 crossbreeding of heterozygotes.

144 For both *vtg* KO lines, the relative level of expression of each individual *vtg* transcript in livers of
145 Hm, Ht, and wt F3 generation females were compared to those obtained for Wt female liver. KO of type-I
146 *vtgs* resulted in the absence of *vtg1*, *vtg4*, and *vtg5* transcripts in F3 Hm *vtg1*-KO female liver,
147 representing a significant decrease in levels of these transcripts compared to Ht, wt and Wt females
148 ($p < 0.05$). Levels of *vtg6* and *vtg7* transcripts were still detectable, with *vtg7* transcript levels being
149 significantly higher (~3-fold) in Hm *vtg1*-KO female liver as compared to Wt female liver ($p < 0.05$). The
150 *vtg1*-KO had no significant effect on *vtg2* and *vtg3* expression (**Fig 4A**). No *vtg3* transcripts were detected
151 in F3 Hm *vtg3*-KO female livers, this representing a significant decrease in *vtg3* transcript levels
152 compared to Ht, wt and Wt females ($p < 0.05$). The F3 Hm *vtg3*-KO females showed a statistically
153 significant ~3-fold increase in hepatic *vtg7* transcript levels relative to Wt fish ($p < 0.05$). No significant
154 effect of *vtg3*-KO on expression of other *vtg* genes was observed (**Fig 4B**).

155 The relative abundances of individual Vtgs or of their product yolk proteins were evaluated in
156 liver and eggs, respectively, of F3 Hm *vtg1*-KO females as normalized spectral counts (N-SC) from LC-
157 MS/MS. These measurements revealed no detectable amount of Vtg1, 4 or 5 protein ($p < 0.05$) (**Fig 5A**).
158 Similar to gene expression levels in these same samples, Vtg6 and 7 proteins were still detectable, with
159 Vtg7 protein levels being significantly higher in Hm *vtg1*-KO female liver and eggs than in corresponding
160 samples from Wt females. ($p < 0.05$). The relative abundance of Vtg7 protein was ~4-fold and ~3-fold
161 higher in Hm *vtg1*-KO liver and eggs, respectively, than in Wt females. Additionally, even though they
162 were uniformly low, Vtg3 protein levels were also significantly higher (~2-fold) in Hm *vtg1*-KO eggs
163 than in Wt eggs ($p < 0.05$) (**Fig 5A**).

164 The *vtg3*-KO resulted in the absence of detectable Vtg3 protein in both liver and eggs of F3 Hm
165 *vtg3*-KO females ($p < 0.05$) but it did not seem to influence the relative abundances of Vtg1, 2, 4, 5, and 6,
166 or of their yolk protein products, in these samples (**Fig 5B**). However, Vtg7 protein levels were
167 significantly higher (~1.5-fold) in *vtg3*-KO eggs than in Wt eggs ($p < 0.05$), but *vtg3*-KO did not
168 significantly alter the relative abundance of Vtg7 protein in the liver of the egg donors, although average
169 levels were higher in the *vtg3*-KO fish (**Fig 5B**). In *vtg1*-KO, *vtg3*-KO and Wt females, relative protein
170 abundances for all detected Vtgs were generally lower in liver in comparison to eggs. Among the various
171 forms of Vtg protein, their relative abundance in eggs from Wt females ranged from 15 to 31 times higher
172 than in livers of the same fish.

173 Domain-specific, affinity purified polyclonal antibodies were developed in rabbits against
174 zebrafish (zf) Vtg type-specific epitopes (Type-I Vtg: NEDPKANHIIIVTKS on LvH1; Type-III Vtg:
175 AQKDDIEMIVSEVG on LvL3. See **Fig 2**). The antibodies were used to detect these proteins by Western
176 blotting in the respective Hm *vtg*-KO, Ht and Wt female livers, ovaries and eggs. The rabbit anti-zfLvH1
177 antibody revealed the presence of high molecular weight bands corresponding in mass to LvH1 in all
178 tested individuals and tissues (*data not shown*), consistent with the reported escape of the *vtg6* and *vtg7*
179 from Cas9 editing and the presence of Vtg6 and Vtg7 protein in liver, ovary and eggs from all groups of
180 fish in the *vtg1*-KO experiment (Hm, Ht and Wt). In Western blots performed using anti-zfLvL3 in the

181 *vtg3*-KO experiment, the antibody detected mainly a bold ~24 kDa band in samples of both ovary and
182 eggs from Ht and Wt fish, but not from Hm fish, very close to the deduced mass of the LvL3 polypeptide
183 (21.3 kDa) (Yilmaz et al., 2018) (**Fig 6**). Zebrafish LvLs were previously shown to migrate to this
184 position in SDS-PAGE (Yilmaz et al., 2017). The distinct absence of the ~24 kDa band only in samples
185 of Hm ovary and eggs is considered to be evidence of successful *vtg3*-KO in this experiment. The very
186 bold ~68 kDa band also present in samples of ovary and eggs from Ht and Wt females, but absent in
187 samples from Hm *vtg3*-KO fish, which have a faint band in this position, may represent a degradation
188 product of intact, covalently linked LvH-LvL conjugate (Vtg3) persisting after maturational proteolysis,
189 as has been described for several species (Reading et al., 2009). Faint high molecular weight bands
190 mainly ≥ 68 kDa were also evident for samples of liver, ovary and eggs from all individuals and from all
191 groups of fish in the *vtg3*-KO experiment (Hm, Ht and Wt). These bands are taken to indicate slight non-
192 specific binding of the antibody with yolk proteins under the experimental conditions employed. For Ht
193 and Wt fish, some of these bands may represent high molecular weight Vtg3 products bearing intact or
194 partially degraded LvL3, as noted above. No bands specific to Ht and Wt fish were detected in Western
195 blots of liver performed using this antibody, consistent with absence of significant quantities of Vtg3
196 protein detectable in Wt liver by LC-MS/MS (**Fig 5B**), a commonly observed phenomenon (see Yilmaz et
197 al., 2016) suggesting that Vtg3 is rapidly released into the bloodstream after synthesis.

198 Phenotypic parameters including number of eggs per spawn, egg fertilization, hatching and
199 survival rates, and egg diameter (embryo and chorion diameter) as well as larval size at 8 days post
200 fertilization (dpf), were measured to detect potential effects of *vtg* KO on zebrafish reproductive
201 performance and development. There were no significant differences between Hm *vtg1*-KO and Wt eggs
202 or offspring in fertilization rate, embryo size or larval size, respectively (**Fig 7**). However, F3 Hm *vtg1*-
203 KO females produced significantly more eggs per spawn (593 ± 40.06 , mean \pm SEM) than did Wt
204 females (280 ± 28.97) ($p < 0.05$), although the final hatching rate of these embryos at 10 dpf (64.9 ± 6.45
205 %) was significantly lower than for embryos from Wt females (99.6 ± 0.24 %) ($p < 0.05$). Embryos from
206 F3 Hm *vtg1*-KO females also were strikingly delayed in hatching, completing hatching at 9 dpf versus 5

207 dpf for control fish (**Fig 7**). It was noted that the Hm *vtg1*-KO embryos appeared to have weaker
208 heartbeats and body movements during incubation antecedent to hatching as compared to *vtg3*-KO
209 embryos, which, even with malformations, exhibited apparently normal heartbeat rhythms and body
210 movements comparable to those seen in Wt embryos. Embryo and larval survival rates of Hm *vtg1*-KO
211 offspring were also significantly lower than for Wt offspring, beginning from 5 dpf when their mean
212 survival rate was 57.14 ± 7.34 % compared to 79.40 ± 5.75 % for Wt fish. The survival rate of Wt
213 offspring changed little thereafter, whereas the survival rate of Hm *vtg1*-KO offspring continued to
214 decline, with *vtg1*-KO being completely lethal to the larvae by 16 dpf (**Fig 8**).

215 There were no significant differences between Hm *vtg3*-KO fish and Wt fish in number of eggs
216 per spawn, embryo size or larval size (**Fig 7**). However, the fertility, hatching rate and overall survival of
217 Hm *vtg3*-KO eggs and offspring, respectively, were significantly less than seen in Wt fish ($p < 0.05$) (**Fig**
218 **7**). The fertilization rate of eggs from F3 Hm *vtg3*-KO females (35.5 ± 7.7 %) was substantially lower
219 than for Wt eggs (81.6 ± 7.0 %), although hatching of eggs from these females was only slightly delayed,
220 and to a much lesser extent than was observed for eggs from the F3 Hm *vtg1*-KO females (*see below*).
221 The final hatching rate for eggs obtained from F3 Hm *vtg3*-KO females was 74.3 ± 7.7 % at 10 dpf
222 compared to 99.6 ± 0.24 % for Wt eggs (**Fig 7**). Embryo and larval survival rates of Hm *vtg3*-KO
223 offspring were significantly less than for Wt offspring ($p < 0.05$), beginning from 8 hours post fertilization
224 (hpf), with the difference from Wt fish increasing throughout the 22 days experiment (**Fig 8**). As
225 previously reported (Yilmaz et al., 2017), at 2–4 hpf eggs from low fertility spawns have a high incidence
226 of abnormal embryos with asymmetric cell cleavage and/or developmental arrest at early cleavage stages.
227 Such embryos may survive to 8 hpf but not to 24 hpf. The larval survival rate for Hm *vtg3*-KO offspring
228 was only 6.25 ± 1.6 % at 22 dpf compared to 69.2 ± 3.8 % for Wt offspring (**Fig 8**).

229 Separate panels in **Fig 9** illustrate morphological disorders observed during development of F4
230 Hm *vtg1*-KO and Hm *vtg3*-KO fish in comparison to offspring from Wt females at 4 and 8 dpf. In Hm
231 *vtg*-KO fish, these phenotypic disorders mainly involved pericardial and yolk sac/abdominal edema
232 accompanied by spinal lordosis evidenced as curved or bent back deformities. The severity of these

233 malformations, mainly the pericardial and yolk sac edema, appeared to be relatively lower in Hm *vtg1*-
234 KO fish than in Hm *vtg3*-KO fish. However, the prevalence of deformity was much greater for Hm *vtg1*-
235 KO fish, with nearly all larvae exhibiting some degree of deformity versus approximately 30 % of Hm
236 *vtg3*-KO larvae. Finally, the Hm *vtg1*-KO larvae exhibited no feeding activity or motor activities
237 comparable to those seen in Hm *vtg3*-KO and Wt fish at the same times.

238

239

240 3. DISCUSSION

241 Vitellogenins are the ‘mother proteins’ that supply most yolk nutrients supporting early vertebrate
242 development, and most species have evolved multiple forms of Vtg. However, little is known about
243 specific functions of these different forms of Vtg and it is uncertain which forms are essential for
244 successful development or at what stage(s) of development they are required. The present research was
245 undertaken to address these questions using a zebrafish CRISPR/Cas9 *vtg* gene KO model. Three out of
246 five type-I zebrafish *vtg* genes (*vtg1*, 4 and 5) were knocked out simultaneously (*vtg1*-KO experiment),
247 and the type-III *vtg* gene (*vtg3*) was knocked out individually (*vtg3*-KO experiment), and the effects on
248 maternal reproductive physiology and offspring development and survival were evaluated. To the best of
249 our knowledge, these findings constitute the first reports of *vtg* gene KO and its consequences in any
250 animal.

251 The efficacy of CRISPR/Cas9, which is reported to be the most practical and efficient tool
252 available for genome editing, was lower in the *vtg1*-KO experiment (20 %), where five genes were
253 targeted concomitantly, than in the *vtg3*-KO experiment (80 %) where only a single gene was targeted.
254 Since the site-specific cleavage efficiency is mostly dependent on the concentrations of single guide (sg)
255 RNAs and Cas9 endonuclease, Liu et al. (2018) related the low efficiency of simultaneous knockout of
256 multiple homologous genes to the fact that more sgRNAs and gene target sites share the same Cas9
257 enzyme. In addition to low efficiencies in the *vtg1*-KO experiment, the escape of the type-I *vtg6* and *vtg7*
258 from Cas9 editing might be simply an outcome of an insufficient amount of administered Cas9 RNA.

259 Attempts at optimization of sgRNA/Cas9 concentrations may be useful in future studies. Taking into
260 account the syntenic organization and close proximity of type-I *vtg* genes in zebrafish (Yilmaz et al.,
261 2018, **Fig 1**), and the identity (100 %) of the common target sites for these genes, it is difficult to
262 postulate criteria upon which any preference of Cas9 activity might be directed. No matter which gene-
263 editing tool is used, low efficiency of germline mutant transmission has been a commonly faced problem
264 among researchers, usually leading to labor intensive and time consuming screening work to acquire
265 high-throughputs (Xie et al., 2016). The low ratios of mutation transmission to next generations in the
266 present study (0.01 % - 0.025 %) emphasize the need for further research to improve germline
267 transmission efficiencies in genome editing. Production of stable mutant lines was delayed an extra
268 generation in both the *vtg1*-KO and *vtg3*-KO experiments since no mutation-positive female founders
269 were obtained at the F1 generation for performing subsequent reproductive crosses.

270 The incapacitation of *vtg1*, *vtg4*, and *vtg5* in the *vtg1*-KO experiment, and of *vtg3* in the *vtg3*-KO
271 experiment, was confirmed by conventional PCR, agarose gel electrophoresis and sequencing of gDNA
272 and also by relative quantification of corresponding *vtg* transcript and Vtg protein abundances via qPCR
273 and LC-MS/MS, respectively, with the absence of Vtg3 protein in Hm *vtg3*-KO ovary and eggs being
274 additionally confirmed by Western blotting. The absence of transcripts for *vtg1*, *vtg4* and *vtg5* in liver of
275 F3-generation homozygous mutant females and lack of the respective Vtg proteins in both liver and eggs
276 collected from these females, proven by the results of qPCR and LC-MS/MS, provided strong evidence of
277 concomitant incapacitation of *vtg1*, 4 and 5 in this study. Therefore, and furthermore to avoid
278 complications due to high sequence identities among type-I *vtg* genes, detailed genotyping by sequencing
279 was conducted for *vtg1* only as a representative of type-I *vtgs*, and also for *vtg3*. The specific alterations
280 made to *vtg4* and *vtg5* gDNA during CRISPR/Cas9 editing were not otherwise visualized.

281 The introduced mutations were large deletions achieved by administration of multiple sgRNAs.
282 The 1181 bp deletion confirmed in *vtg3* mutants closely matched the sequence bounded by flanking guide
283 RNAs sg32 and sg33. However, the 1281 bp deletion overlapping sg12 in *vtg1* mutants was much smaller
284 than would result from excision between the flanking sg11 and sg13 (**S1 Fig A**). It is possible that

285 homologous recombination initiated in the heterozygous F0 mutant after Cas9 editing, combined with any
286 other non-homologous and/or homology-directed repairs, may have contributed to restoration of much of
287 the sequence between sg11 and sg12, as well as the short sequence between the 1281 bp deletion and
288 sg13. In the end, we pursued this unexpected *vtg1* mutant because the annotated deletion was predicted to
289 incapacitate the gene (**S1 Fig G**, see also **S2 Fig**), an expectation later verified by the absence of *vtg1*
290 transcripts and of Vtg1 protein, and because early generational screening indicated that it was heritable.

291 In gene family editing experiments where family members are closely arrayed in tandem on the
292 same chromosome, as are the zebrafish type-I *vtgs* (see **Fig 1**), the use of pooled guide RNAs common to
293 all genes creates the possibility of deletions spanning several genes. In this study, while the deletion in
294 *vtg1* was localized to a specific position via genotyping by sequencing, the corresponding deletions in
295 *vtg4* and *vtg5* mutants were not, although their KO status was confirmed by the lack of relevant
296 transcripts and proteins. Expression of both mRNA and protein were clearly detected for *vtg7*, which is
297 located in the middle of the type-I *vtg* cluster and is flanked by *vtg4* and *vtg5* (**Fig 1**). Therefore, no large
298 deletion spanning these three *vtgs* could have occurred. The *vtg6* is located at the far end of the cluster
299 separated from *vtg5* only by *si:rp71-23d18.4*, a gene lacking targets for any sgRNAs employed in this
300 study whose predicted transcript encodes an uncharacterized non-Vtg protein. A deletion spanning *vtg5*,
301 *si:rp71-23d18.4* and *vtg6* did not occur, as *vtg6* transcripts and their encoded proteins were also detected.
302 Therefore, we surmise that our *vtg4* and *vtg5* mutants did not arise from deletions spanning several genes.
303 It appears that our experimental design effectively targeted 3 of 5 type-I *vtg* genes for incapacitation (KO)
304 and this action was apparently restricted to the individual genes.

305 By disturbing the structure of the LvH chain in both the *vtg1*-KO and *vtg3*-KO experiments via
306 the creation of large gaps in the respective LvH polypeptides, it was expected that the mutant proteins
307 would not fold properly, or be able to bind to their receptor in the case of Vtg3, even if they were
308 produced and partly expressed by the liver. However, there were no signs of hepatic synthesis of Vtg1, 4
309 or 5 in Hm *vtg1*-KO individuals or of Vtg3 in Hm *vtg3*-KO liver. We surmise that the predicted deletions
310 in the sequences encoding Vtg1 and Vtg3 led to premature termination of transcription and rapid

311 transcript degradation without translation. The affected regions of the transcripts encoding LvH including,
312 in the case of LvH3, its Vtg receptor-binding domain, may be essential for production and translation of
313 stable transcripts.

314 While detection of the *vtg6* and *vtg7* transcripts and their product proteins was expected in the
315 *vtg1*-KO experiment, since these two type-I *vtg* genes escaped Cas9 editing, the strikingly high abundance
316 of Vtg7 (but not Vtg6) at both transcript and protein levels in both Hm *vtg1*-KO and Hm *vtg3*-KO
317 individuals (**Figs 4 and 5**) was unexpected. These observations suggest an attempt of the organism to
318 compensate for the loss of other types of Vtgs by augmentation of Vtg7 levels, and they imply the
319 existence of heretofore-unknown mechanisms for regulating Vtg homeostasis.

320 The lack of a mutant phenotype in Hm mutant individuals due to compensatory gene expression
321 triggered upstream of protein function is known as ‘genetic compensation’ and this phenomenon has been
322 encountered in gene editing studies of a wide range of model organisms. As examples, Marschang et al.
323 (2004) related the normal development and lack of mutant phenotypes in LDL receptor-related protein 1b
324 (*LRP1b*)-deficient mutant mice to functional compensation by *LRP1*, and Sztal et al. (2018) found that a
325 genetic *actin1b* (*actc1b*) zebrafish mutant exhibits only mild muscle defects and is unaffected by injection
326 of an *actc1b*-targeting morpholino due to compensatory transcriptional upregulation of an *actin* paralog in
327 the same fish. In the present study, compensatory increases in relative levels of total Vtg protein
328 attributable to upregulation of Vtg7 protein in F4 Hm *vtg1*-KO eggs offset only about half of the decrease
329 in total Vtg protein attributable to KO of *vtg1*, 4 and 5 (**Fig 5A**). Therefore, these eggs/offspring were still
330 deficient of type-I Vtg protein and they uniformly exhibited mutant and ultimately lethal phenotypes,
331 perhaps due to the insufficient compensation. In contrast, the compensatory increase in total Vtg protein
332 attributable to upregulation of Vtg7 in Hm *vtg3*-KO eggs was several-fold greater than the loss of Vtg
333 protein attributable to *vtg3* KO (**Fig 5B**), yet many of these eggs/offspring still exhibited mutant
334 phenotypes, with egg fertility being very low (*see below*) and most offspring not surviving for 22 d of
335 development. Nonetheless, the incidence of mutant phenotypes in Hm *vtg3*-KO larvae (30 %) was far less
336 than in Hm *vtg1*-KO larvae, all of which were malformed, and a low percentage (6.25 %) of Hm *vtg3*-KO

337 larvae did survive for 22 d post fertilization, whereas no Hm *vtg1*-KO larvae did. These observations
338 indicate that, while it is possible that upregulation of Vtg7 may have mitigated to some extent the effects
339 *vtg3* KO owing to decreased total Vtg protein, Vtg7 cannot fully substitute for Vtg3 or eliminate the
340 adverse effects of *vtg3* KO on egg fertility and offspring development. Therefore, Vtg3 must have
341 functional properties distinct from Vtg7 and perhaps other type-I Vtgs.

342 Transcription of *vtg* genes is initiated when estrogen (E2)/estrogen receptor (Esr) complexes bind
343 to estrogen response elements (ERE) located in the gene promoter regions (Babin, 2008; Nelson and
344 Habibi, 2013). E2-Esr complexes can also be tethered to transcription factor complexes targeting binding
345 sites distinct from EREs, and several transcription factors other than Esrs have binding sites located in
346 promoter regions of zebrafish *vtg* genes (reviewed by Lubzens et al., 2017). There is evidence that the
347 multiple *vtg* genes in zebrafish exhibit differential sensitivities to estrogen induction as well as disparate
348 patterns of ERE and other transcription factor binding sites in their promoter regions (Levi et al., 2009,
349 2012). Bioinformatics analyses indicated that the promoter region of *vtg7* is comparatively rich in binding
350 sites for transcription factors involved in retinoic acid signaling such as retinoic acid response elements
351 (RAREs) and peroxisome proliferator-activated receptors (PPARs)/retinoid X receptor (RXR), while
352 having only a single ERE (most other *vtgs* having 2-3) (see Levi et al., 2012 Table 3). These types of
353 differences between *vtg* promoters could underpin selective upregulation of Vtg7 in response to ablation
354 of other forms of Vtg (other type-I Vtgs, Vtg3) via gene KO. Conspecific Vtg (type not specified) has
355 been shown to downregulate plasma levels of E2 *in vivo* when injected into vitellogenic rainbow trout
356 (*Oncorhynchus mykiss*) (Reis-Henriques et al., 1997) and to inhibit steroidogenesis leading to E2
357 production *in vitro* by ovarian follicles of rainbow trout (Reis-Henriques et al., 1997, 2000) and greenback
358 flounder, *Rhombosolea tapirina* (Sun and Pankhurst, 2006). Partial release from such inhibition in *vtg*-
359 KO fish would increase vitellogenic signaling to the liver, activating estrogen responsive genes including
360 those encoding Vtgs, Esr (Esrs) and PPARs.

361 Whether Vtg7 itself has vitellogenic properties remains to be determined. Certain conspecific
362 Vtgs have been shown to upregulate vitellogenesis in Indian walking catfish (*Clarias batrachus*) (Jain et

363 al., 2017; Bhattacharya et al., 2018) and comparisons of the available deduced catfish Vtg polypeptide
364 sequences (85 and 152 residues; Juin et al., 2017, Fig. 3) to Vtgs from zebrafish and other teleosts using
365 CLUSTAL W and BLASTP (*data not shown*) indicate that they are forms of VtgA01 showing a high
366 identity to type-I zebrafish Vtgs (up to 80% in the case of Vtg7). The specific mechanism(s) by which
367 Vtg7 is preferentially upregulated in *vtg*-KO zebrafish, and special properties of Vtg7 for regulation of
368 Vtg homeostasis, are meaningful subjects for future research. Levels of Vtg3 protein were also
369 upregulated in eggs from F3 Hm *vtg1*-KO females (**Fig 5A**) but the significance of this increase is
370 difficult to interpret as it was too slight to have much impact on total Vtg levels, and because hepatic
371 levels of *vtg3* transcripts and of Vtg3 protein were not elevated in these same fish (**Figs 4A and 5A**).
372 Transcripts of *vtg3* are reported to be the most intensely upregulated transcripts in vitellogenic female and
373 estrogenized male zebrafish (Levi et al., 2009) and there may not have been scope for further increases in
374 the *vtg1*-KO fish. In this case, post-transcriptional mechanisms for upregulating Vtg3 could have been at
375 play (Flouriot et al., 1996; Ren et al., 1996). As noted above, Vtg3 may be released into the bloodstream
376 immediately after synthesis, which would explain the lack of significant quantities of this protein in livers
377 of Hm *vtg1*-KO and Wt fish (**Fig 5A**).

378 Neither *vtg1*-KO nor *vtg3*-KO influenced egg, embryo or larval size in spawns producing F4
379 offspring of the stable mutant lines (**Fig 7**), and there were no apparent differences in ovary structure
380 among the different groups of maternal F3 females (Hm, Ht, wt and Wt) sampled after spawning (*data*
381 *not shown*). However, F3 Hm *vtg1*-KO females exhibited a 2-fold increase in number of produced eggs
382 relative to Wt females, with normal egg fertility equivalent to that of Wt females (**Fig 7**). This response to
383 elimination of three type-I Vtgs (including the most abundant one, Vtg1) implies that one or more of these
384 Vtgs are normally involved in restriction of fecundity, perhaps via the aforementioned inhibition of
385 follicular estrogenesis. It is also possible that Vtg7, which was highly elevated in Hm *vtg1*-KO females,
386 might somehow positively modulate fecundity. The referenced VtgA01 of walking catfish, when pelleted
387 and implanted into pre-vitellogenic females, has been shown to stimulate vitellogenesis and complete
388 oocyte growth all the way through the transition to final maturation (Bhattacharya et al., 2018). In the

389 final analysis, any ‘compensation’ by Vtg7 for loss of other type-I Vtgs must be deemed ineffectual, as
390 the resulting embryos unconditionally exhibited serious and lethal developmental abnormalities (*see*
391 *below*).

392 The *vtg*-KO zebrafish larvae exhibited major phenotypic disorders, mainly pericardial and yolk
393 sac/abdominal edemas and spinal lordosis associated with curved or arched back deformities. These
394 abnormalities were observed to be much less prevalent, albeit usually more severe, in *vtg3*-KO larvae, but
395 present to some extent in all *vtg1*-KO larvae along with the noted behavioral differences. Skeletal axis
396 malformations and pericardial and yolk sac/abdominal edema are among the most common deformities
397 observed in cultured teleosts and they form an interrelated cluster of abnormalities that tend to be
398 observed together (Alix et al., 2017). For example, pericardial edema tends to precede development of
399 yolk sac edema in zebrafish, which when severe leads to notochord deformation (see Hanke et al., 2013,
400 Fig. 1). These abnormalities have been associated with a broad variety of conditions including, as
401 examples, rearing systems for Eurasian perch, *Perca fluviatilis* (Alix et al., 2017), larval rearing
402 temperatures for Atlantic halibut, *Hippoglossus hippoglossus* L. (Ottesen and Bolla, 1998), embryo
403 cryopreservation practices for streaked prochilod, *Prochilodus lineatus* (Costa et al., 2017), and, in
404 zebrafish, phenanthroline toxicity (Ellis and Crawford, 2016), influenza A virus infection (Gabor et al.,
405 2014), knockdown or KO of genes related to kidney function or development, respectively (Hanke et al.,
406 2013; Zhang et al., 2018), knockdown of the *wwox* tumor suppressor gene (Tsuruwaka et al., 2015),
407 deletion of a gene (*pr130*) encoding a protein essential for myocardium formation and cardiac contractile
408 function (Yang et al., 2016), and mutagenesis of genes involved in thyroid morphogenesis and function
409 (Trubiroha et al., 2018), among others. The edemas may ultimately result from many different proximal
410 causes such as cardiac, kidney, liver or osmoregulatory failure, and researchers are just beginning to
411 develop screens to differentiate between them (Hanke et al., 2013). Although they can occur under many
412 different conditions and arise via several possible mechanisms, these major mutant phenotypes observed
413 in the present study were not encountered in control Wt offspring and, therefore, they are clearly related
414 to deficiencies of type-I Vtgs (Vtg1, 4 and 5) and of Vtg3. The question of whether these phenotypes

415 result from loss of Vtg1 alone or are an effect of ablation of Vtg1 in combination with Vtg4 and/or Vtg5
416 will need to be addressed in future research.

417 Embryo and larval survival rates were severely diminished by *vtg* gene KO, but the magnitude,
418 type and timing of losses differed between *vtg1*-KO and *vtg3*-KO fish (**Fig 8**). The fertility of Hm *vtg3*-
419 KO eggs was only half that observed in Wt eggs (**Fig 7**), indicating that Vtg3 is an important contributor
420 to fertility in zebrafish. Among the Vtgs examined, this dependency was specific to Vtg3, since fertility
421 was not ‘rescued’ by the increase in Vtg7 levels in Hm *vtg3*-KO eggs, which was far greater than normal
422 Vtg3 levels in Wt fish (**Fig 5B**), and this adverse effect on fertility was not seen in Hm *vtg1*-KO eggs. The
423 substantial losses of Hm *vtg3*-KO eggs began early, at only 8 hpf, and less than 30% survived to 24 hpf
424 (**Fig 8**). Both *vtg1*-KO and Wt eggs showed significant but much fewer losses ($p < 0.05$) during this same
425 interval. In this study, fertility was estimated conservatively, based on numbers of viable embryos
426 showing normal cell division and subsequently developing to ~24 hpf. It is uncertain whether the high
427 mortality of Hm *vtg3*-KO eggs between 8 and 24 hpf (**Fig 8**) resulted from a failure to be fertilized or
428 from defects in early development involving zygotes that fail to initiate cell division or that briefly
429 undergo abnormal cell divisions and then die. In future studies, some Hm mutant and Wt females should
430 be bred with males bearing a unique germline marker gene, such as *vasa::egfp* (Krøvel and Olsen, 2002),
431 that can be genotyped in resulting eggs and embryos to resolve this question.

432 The mechanism(s) whereby Vtg3 deficiency impairs fertility and/or early development of
433 zebrafish are unknown. A recent study examining the proteomics of egg/embryo developmental
434 competence in zebrafish identified disruption of normal oocyte maturation, including maturational
435 proteolysis of Vtgs, as a likely cause of poor egg quality (Yilmaz et al., 2017). The proteolysis of Vtgs by
436 cathepsins during oocyte maturation, a phenomenon that has been observed in zebrafish eggs undergoing
437 maturation *in vitro* (Carnevali et al., 2006), releases FAA that steepen the osmotic gradient driving water
438 influx through aquaporins on the cell surface, leading to oocyte hydration (Cerdà et al., 2007, 2013).
439 These FAA are also major substrates for aerobic energy metabolism during early embryogenesis (Thorsen
440 and Fyhn, 1996; Finn and Fyhn, 2010). In some species, Vtg3 (VtgC) is subjected to maturational

441 proteolysis (see Yilmaz et al., 2016) and it is possible that zebrafish Vtg3 contributes to these critical
442 processes ongoing during oocyte maturation, which are required for production of viable eggs. However,
443 mass balance considerations seem to exclude the possibility that the early mortality of Hm *vtg3*-KO
444 embryos results substantially from nutritional deficiencies. In this and prior studies of zebrafish, Vtg3 has
445 been shown to be a very minor form of Vtg making only a miniscule contribution to stores of Vtg-derived
446 yolk proteins in eggs (**Fig 5**; see also Yilmaz et al., 2018). Nonetheless, Vtg3 is clearly an important, if
447 not essential, contributor to fertility and/or early development in zebrafish. The continuous mortality of
448 Hm *vtg3*-KO embryos after 24 hpf, leading to only ~6% survival at 22 dpf, suggests that Vtg3 also
449 contributes to late embryonic and larval development, as suggested in several prior studies (see below).

450 Survival of embryos emanating from Hm *vtg1*-KO females remained relatively high at 24 hpf
451 (~70%) but decreased continuously thereafter, becoming significantly less than survival of Wt embryos
452 by 5 dpf, and then decreasing to zero by 16 dpf (**Fig 8**). The collective absence of Vtg1, 4 and 5 in
453 zebrafish is lethal to offspring, and this effect could not be rescued via genetic compensation by Vtg7 or
454 offset by the remaining intact Vtgs. This finding is not surprising as, collectively, these 3 type-I Vtgs
455 account for the vast majority of Vtg-derived protein in Wt zebrafish eggs (**Fig 5**; see also Yilmaz et al.,
456 2018). Since most mortality of *vtg1*-KO offspring occurred relatively late in larval development, with
457 mortality rate increasing after 10 dpf when yolk sac absorption was being completed (**Fig 8**), the
458 collective contributions of Vtg1, 4 and 5 to survival could be largely nutritional, although this remains to
459 be verified.

460 It is evermore apparent that the different types of vertebrate Vtg can have dissimilar effects on
461 reproductive processes. As noted above (see also Introduction), in marine acanthomorphs spawning
462 pelagic eggs in seawater the different types of Vtg can play disparate roles in oocyte hydration,
463 acquisition of egg buoyancy, and early versus late embryonic and larval nutrition (Matsubara and Koya,
464 1997; Matsubara et al., 1999, 2003; Reith et al., 2001; Sawaguchi et al., 2005, 2006a, 2006b; Finn, 2007).
465 The type-specific ratios of circulating Vtgs (e.g. VtgAa:VtgAb:VtgC) may vary considerably during
466 oocyte growth, but ratios of their derived yolk protein products present in eggs tend to be fixed and

467 characteristic of species (Hiramatsu et al., 2015; Reading et al., 2017). This is also the case in zebrafish
468 as evidenced by the similarity of Vtg profiles by type (and subtype) in Wt fish in the *vtg1*-KO and *vtg3*-
469 KO experiments, and also in comparison to Wt fish in an earlier study (Yilmaz et al., 2018). It is thought
470 that Vtg type-specific ratios of yolk proteins in eggs are maintained via activity of selective receptors for
471 each type of Vtg, which target their specific ligand(s) into different compartments where their yolk
472 protein products undergo disparate degrees of proteolysis during oocyte maturation. The initial abundance
473 and degree of proteolysis of the yolk proteins determines their relative contribution(s) to oocyte
474 hydration, egg buoyancy, FAA nutrition of early embryos and lipoprotein nutrition for late stage larvae
475 (Hiramatsu et al., 2015; Reading et al., 2017). The collective findings of the present study introduce a new
476 point of view on the roles that multiple vitellogenins can play in vertebrate reproduction. Distinctively
477 from what has been reported previously, the present study presents a mixed model of Vtg functionality
478 covering both maternal reproductive physiology and early development of offspring, where type-I Vtgs
479 regulate fecundity and make essential contributions to embryonic morphogenesis, hatching and larval
480 kinesics and survival (Vtg1, 4 and 5), and also provide some homeostatic regulation of total Vtg levels
481 (Vtg7), while Vtg3 (a typical VtgC) is critically important to fertility and early embryogenesis and also
482 influences later development.

483 The forgoing discussion identifies potential reproductive and developmental actions of certain
484 type-I Vtgs (Vtg1, Vtg4, and Vtg5) and of Vtg3 based upon the results of incapacitation of their
485 respective genes, as evidenced by elimination of their product transcripts and proteins. While such
486 observations provide powerful evidence for these many actions, some novel, we cannot exclude
487 involvement of the remaining Vtgs in regulation of the same physiological processes. Undetected effects
488 of genome editing on *vtg6* and *vtg7*, short of wholesale elimination of their transcripts or product proteins,
489 could have contributed to development of the noted '*vtg1*-KO phenotypes'.

490 In summary, the present study, for the first time, targeted multiple forms of Vtgs for KO at family
491 level using CRISPR/Cas9 technology in the zebrafish, a well-established biomedical model. The
492 collective knock out of *vtg1*, 4, and 5 and the individual knock out of *vtg3* were achieved successfully. A

493 compensatory increase in *vtg7* at both transcript and protein levels was observed in both types of *vtg* KO
494 mutants. However, this compensation was not effective in rescuing the serious developmental
495 impairments and high mortalities resulting from ablation of three other type-I Vtgs or of Vtg3. Whether
496 the detected phenotypes result from the absence of a single type-I *vtg* or is a result of collective
497 incapacitation of *vtg1*, *vtg4* and *vtg5*, needs further research. However, by far the most abundant forms of
498 Vtg in zebrafish, the type-I Vtgs appear to have essential developmental and nutritional functions in both
499 embryos and larvae. In spite of being a very minor form of Vtg in zebrafish and most other species, and
500 also the most divergent form, Vtg3 contributes importantly to the developmental potential of zygotes
501 and/or early embryos. Finally, Vtgs appear to have previously unreported regulatory effects on the
502 physiology of maternal females, including limitation of fecundity (type-I Vtgs) and maintenance of
503 fertility (Vtg3). These novel findings represent the first steps toward discovery of the specific functions of
504 multiple vertebrate Vtgs via genome editing. Further physiological studies are necessary to pinpoint the
505 exact molecular mechanisms disturbed in the *vtg* mutants.

506

507

508 **4. MATERIAL AND METHODS**

509

510 **4.1. Animal care, spawning and phenotypic observations**

511 Zebrafish of the Tübingen strain originally emanating from the Nüsslein-Volhard Laboratory
512 (Germany) were obtained from our zebrafish facility (INRA UR1037 LPGP, Rennes, France). The fish
513 were ~15 months of age and of average length ~5.0 cm and average weight ~1.4 g. The zebrafish were
514 housed under standard conditions of photoperiod (14 hours light and 10 hours dark) and temperature (28
515 °C) in 10 L aquaria and were fed three times a day *ad libitum* with a commercial diet (GEMMA,
516 Skretting, Wincham, Northwich, UK). Females were bred at weekly intervals to obtain egg batches for
517 CRISPR sgRNA microinjection (MI). The night before spawning, paired males and females bred from
518 different parents were separated by an opaque divider in individual aquaria equipped with marbles at the

519 bottom as the spawning substrate. The divider was removed in the morning, with the fish left undisturbed
520 to spawn. Egg batches in majority containing intact, clean looking, well defined, activated eggs at the 1-
521 cell stage were immediately transferred to microinjection facilities.

522 For phenotyping observations five couples formed from F3 Hm males and females and five Wt
523 couples were spawned from 3 to 8 times and embryonic development, survival rate, hatching rate, and
524 larval development were subsequently observed until 22 dpf. Survival, fecundity and fertilization rate
525 data was collected from 21, 24 and 5 spawns from *vtg1*-KO, *vtg3*-KO and Wt couples, respectively.
526 Hatching rate was calculated based on the number of surviving embryos at 24h and only spawns with > 5
527 % survival rates were considered, therefore, hatching rate data was collected from 21, 16, and 5 spawns
528 from *vtg1*-KO, *vtg3*-KO and Wt couples, respectively, in this study. Fecundity (number of eggs per
529 spawn) was recorded immediately after spawning and collected eggs were incubated in 100 mm Petri
530 dishes filled with embryo medium (17.1 mM NaCl, 0.4 mM KCl, 0.65 mM MgSO₄, 0.27 mM CaCl₂, 0.01
531 mg/L methylene blue) to assess embryonic development and phenotyping parameters. Incubated
532 eggs/embryos were periodically observed at the early blastula (~256 cell) stage (~2-3 h post fertilization
533 hpf), at mid-blastula transition stage (~4 hpf), at the shield to 75% epiboly stages (~8 hpf), at the early
534 pharyngula stage (~24 hpf), and during the hatching period at 48 and 72 hpf (long-pec to protruding-
535 mouth stages) following standard developmental staging (Kimmel et al., 1995). Fertilization rate was
536 calculated based on viable embryos showing normal cell division and subsequent development to ~24 hpf
537 since zygotes failing to initiate cell division, and embryos showing asymmetrical cell cleavage or early
538 developmental arrest were dead by then. As noted above (see Discussion) it is uncertain whether these
539 aberrant eggs/embryos result from infertility or developmental defects. The number of surviving
540 eggs/embryos was recorded, those not surviving were removed and the number of abnormal embryos was
541 recorded at each observation point. Hatched embryos were transferred into larger volume containers (1 L)
542 filled with standard 28°C culture water and were fed *ad libitum* with artemia and GEMMA weaning diet
543 mix after yolk sac absorption (at around 10 dpf). At the time of feeding, larvae were also observed for
544 motor and feeding activities. Observations were made daily up to 22 dpf. Subsamples of 10-12 embryos

545 and larvae from each clutch were taken for measurements of embryo and chorion diameter, and larval size
546 at 2-3 hpf and 8 dpf, respectively. Egg diameter refers to diameter of the chorion for each measured egg
547 and embryo diameter refers to the embryo within the egg envelope. Larval size measurements were taken
548 along the anteroposterior axis basis and all measurements were made using an ocular micrometer under a
549 Zeiss Stemi 2000-C stereomicroscope connected to a Toupcam 3,1 M pixels camera employing the
550 Toupview software.

551

552 **4.2. Single guide RNA (sgRNA) design, synthesis and microinjection**

553 Genomic DNA sequences from all five type-I zebrafish *vtgs* were aligned and three target sites
554 common to all five genes were designed using CRISPR MultiTargeter (Prykhozhij et al., 2015) available
555 online at <http://www.multicrispr.net>. Among proposed candidates, three target regions located on exons 4,
556 14 and 17, corresponding to the LvH yolk protein domain were chosen for the *vtgI*-KO experiment. The
557 *vtg3* genomic region was separately submitted to online available target designer tool at
558 <http://zifit.partners.org/ZiFiT/ChoiceMenu.aspx> (Sander et al., 2007, 2010) and of proposed candidates,
559 three gene specific target regions located on exons 4, 6 and 11, corresponding to the LvH yolk protein
560 domain, were chosen. All chosen target sites were additionally tested for their off target potential using
561 the same tools. A schematic representation of the general strategy followed for CRISPR target design is
562 presented in **Fig 1**. Forward and reverse oligonucleotides matching the chosen target sequences (given in
563 **S1 Table**) were annealed and ligated to the pDR274 expression vector (Addgene). The vector was
564 subsequently linearized by the DraI restriction digestion enzyme (Promega) and *in vitro* transcribed using
565 mMessage mMachine T7 Transcription Kit (Ambion) according instructions from the manufacturer. The
566 pCS2-nCas9n plasmid (Addgene Plasmid 47929) was digested with NotI restriction digestion enzyme
567 (Promega) and transcribed using mMessage mMachine SP6 Transcription Kit (Ambion) according
568 instructions from the manufacturer. The sgRNA concentration was measured on a Nanodrop 1000
569 Spectrophotometer (Thermo Scientific, USA) and integrity was tested before use using an Agilent RNA
570 6000 Nano Kit (Agilent) on an Agilent 2100 Bioanalyzer.

571 Approximately 100 eggs per batch were injected with sgRNA mix containing sgRNAs for three
572 target sites (at ~30 ng/ μ l (=30 mM) in 20 μ l of the final mix each) and nCas9n RNA (at ~200 ng/ μ l (=200
573 mM) in the final mix) at the one-cell stage in both the *vtg1*-KO and *vtg3*-KO experiments. A total of 120
574 pg sgRNA mix and ~800 pg Cas9 RNA was injected per embryo. Injected embryos were kept in 100 mm
575 petri dishes filled with embryo medium (17.1 mM NaCl, 0.4 mM KCl, 0.65 mM MgSO₄, 0.27 mM CaCl₂,
576 0.01 mg/L methylene blue) to assess microinjection efficiency, embryo survival and development post
577 injection.

578

579 **4.3. Genotyping by conventional PCR**

580 As representatives of their generation, ten embryos were sampled randomly and gDNA was
581 extracted individually and used as a template in targeted conventional PCR reactions to screen for
582 introduced mutations in the targeted *vtg* genes. For this purpose, embryos surviving for 24 hours post-
583 injection were incubated in 100 μ l of 5 % Chelex® 100 Molecular Biology Grade Resin (BioRad) and 50
584 μ l of Proteinase K Solution (20 mg/ml, Ambion) initially for 2 hours at 55 °C and subsequently for 10
585 minutes at 99 °C with constant agitation at 12000 rpm. Extracts were then centrifuged at 5000 xg for 10
586 minutes and supernatant containing gDNA was transferred into new tubes and stored at -20 °C until use.

587 To evaluate generational transfer of introduced mutations, genotyping of ~2-month-old offspring
588 was conducted after extraction of gDNA from finclips. For this purpose, fish were anaesthetized in 2-
589 phenoxyethanol (0.5 ml/L) and part of their caudal fin was excised with a sterile scalpel. Genomic DNA
590 from fin tissues were then extracted using Chelex 5 % as described above.

591 One μ l (~ 100 ng) of extracted gDNA was used in 20 μ l PCR reactions using AccuPrime™ Taq
592 DNA Polymerase, High Fidelity (Invitrogen) and 10x AccuPrime™ PCR Buffer II in combination with
593 gene specific primer pairs (10 μ M per primer) anchoring target sites on the genomic sequence of targeted
594 genes (**Fig 3**). In cases where one primer of the pair was highly identical to sequences common to more
595 than one form of type-I *vtg*, it was ensured that the other primer was completely specific to *vtg1*.

596

597 PCR cycling conditions were as follows; 1 cycle of initial denaturation at 94 °C for 2 minutes, 35
598 cycles of denaturation at 94 °C for 15–30 seconds, annealing at 52–64 °C for 15–30 seconds and
599 extension at 68 °C for 1 minute per kb plus 1 cycle of final extension at 68 °C for 5 minutes. Non-purified
600 PCR products or gel purified DNA were sequenced using gene specific primers indicated in **S1 Table** by
601 the Eurofins Genomics sequencing service (<https://www.eurofinsgenomics.eu/>). Obtained sequences were
602 aligned to corresponding zebrafish genomic sequence using Clustal Omega (Sievers et al., 2011) for
603 characterization and localization of introduced mutations, and then were blasted against all sequences
604 available online using NCBI nucleotide Blast (Blastn) (Altschul et al., 1990) for confirmation of the
605 consistency, accuracy and type of the mutations created at the target sites.

606

607 **4.4. Generation of pure zebrafish lines carrying the introduced mutations**

608 In both the *vtg1*-KO and *vtg3*-KO experiments, embryos carrying introduced mutations were
609 raised to adulthood, fin clipped and re-genotyped to confirm mutation of their type-I or III *vtgs*, and then
610 heterozygous (Ht; *vtg1*^{+/-} and *vtg3*^{+/-}) males with the mutation on a single allele were outcrossed with
611 non-related wild type (Wt; *vtg1*^{+/+} and *vtg3*^{+/+}) females with no genomic disturbance to produce the F1
612 generation. Embryos from F1 generation were genotyped as stated above and remaining embryos were
613 raised to adulthood. F1 offspring were screened again at ~2 months of age and, since mutation
614 transmission occurred in two males only per group, these Ht males were crossed with Wt females to
615 produce the F2 generation. Following the same genotyping strategy, F2 Ht males were crossed with Ht
616 females to produce the F3 generation. Finally, F3 homozygous (Hm; *vtg1*^{-/-} and *vtg3*^{-/-}) males and Hm
617 females with both alleles carrying the desired mutation were crossed to produce the F4 *vtg* mutants.

618

619 **4.5. Tissue sampling and analyses**

620 Liver and ovary samples from *vtg1*-KO and *vtg3*-KO F3 Hm, Ht, wt and Wt female zebrafish
621 were excised within 2-3 hours after egg collection at the end of phenotyping experiment and after the fish
622 were euthanized with a lethal dose of 2-phenoxyethanol (0.5 ml/L). Ovary samples were aliquoted into

623 four pieces and stored according to subsequent analytical procedures; snap frozen for RNA and protein
624 extraction or placed in Bouin's solution for histological analyses. Liver samples were aliquoted in two
625 pieces and snap frozen until being used for LC-MS/MS or Western blotting.

626

627 **4.6. Quantitative real time PCR**

628 Total RNA was extracted from frozen liver using TriReagent (SIGMA) and cDNA was
629 synthesized using SuperScript III reverse transcriptase (Invitrogen, USA) from 1 µg of total RNA
630 according to the manufacturer's instructions. Relative expression levels for all zebrafish *vtgs* (*vtg1*, 2, 3,
631 4, 5, 6 and 7) in *vtg1*-KO female liver were measured using TaqMan real-time quantitative PCR (RT-
632 qPCR) using gene specific primers and dual-labeled probes (FAM, 6-carboxyfluorescein and a BHQ-1,
633 Black Hole Quencher 1 on 5' and 3' terminus, respectively). Sequences of these primers and probes used
634 in this experiment are given in **S1 Table**. Each qPCR was performed in 10 µl reactions containing cDNA
635 (diluted at 1:25), 600 nM of each primer, 400 nM of hydrolysis probe and 1× TaqMan Fast Advanced
636 Master Mix (Applied Biosystems) according the manufacturer's instructions on a StepOnePlus real time
637 PCR instrument (Applied Biosystems). PCR cycling conditions were as follows: 95°C for 20 seconds, 40
638 cycles at 95°C for 1 second followed by an annealing-extension at 60°C for 20 seconds. The relative
639 abundance of the target cDNA within a sample set was calculated from a serial dilution curve made from
640 the cDNA pool, using StepOne software (Applied Biosystems). The $2^{-\Delta\Delta CT}$ mean relative quantification of
641 gene expression method with zebrafish *18S* as a reference gene was employed in this study. Relative
642 expression levels of all zebrafish *vtgs* in *vtg3*-KO female liver were measured using SYBR GREEN
643 qPCR Master Mix (SYBR Green Master Mix kit; Applied Biosystems) as indicated by the manufacturer
644 in a total volume of 10 µl, containing RT products diluted at 1:1000 and 400 nM of each primer in order
645 to obtain PCR efficiency between 95 and 100 %. Sequences of primers used in this experiment are given
646 in **S1 Table**. The RT-qPCR cycling protocol included 3 minutes initial denaturation at 95 °C followed by
647 40 cycles of 95 °C for 3 seconds and 60 °C for 30 seconds on a StepOnePlus thermocycler (Applied
648 Biosystem). The relative abundance of target cDNA within a sample set was calculated from a serially

649 diluted cDNA pool (standard curve) using Applied Biosystem StepOne V.2.0 software. Similarly, the 2⁻
650 $\Delta\Delta CT$ mean relative quantification of gene expression method with the mean expression value of zebrafish
651 elongation factor 1a (*ef1a*), ribosomal protein 13a (*rpl13a*) and *18S* as reference were employed in this
652 study. Primer sequences and properties for these genes are also given in **S1 Table**. Obtained data was
653 subjected to independent samples Kruskal-Wallis nonparametric test ($p < 0.05$) followed by Benjamini
654 Hochberg correction for multiple tests ($p < 0.1$) (IBM SPSS Statistics Version 19.0.0, Armonk, NY).

655

656 **4.7. Western Blotting**

657 Samples of zebrafish liver, ovary and eggs were homogenized in 100 μ l of protein binding buffer
658 containing 1 mM AEBSF, 10 mM Leupeptin, 1 mM EDTA and 0.5 mM DTT as indicated by Hiramatsu
659 et al. (2002) using a Procellys tissue homogenizer (Bertin Instruments, France). Protein extracts were
660 separated from homogenates with centrifugation at 13 000 rpm +4 °C for 30 minutes to generate
661 supernatant samples for SDS-PAGE. Protein concentrations of the samples were estimated by Bradford
662 Assay (Bradford, 1976) (Bio-Rad, Marnes-la-Coquette, France) and they were diluted to 4 μ g protein μ l⁻¹
663 in ultrapure water, mixed 1:1 v/v with Laemmli sample buffer (Laemmli, 1970) containing 2-
664 mercaptoethanol, and boiled for 5 minutes before electrophoresis. A total of 10 μ g of sample protein was
665 loaded onto a precast 4–15 % acrylamide gradient Tris–HCl Ready Gel® (BioRad, Hercules, CA) with 4
666 % acrylamide stacking gel and electrophoresed at 150 V for 45 minutes using a Tris–glycine buffer
667 system (Laemmli, 1970). Biotinylated protein molecular weight markers (Vector Laboratories, USA)
668 were used to estimate the mass of separated proteins.

669 Proteins in the gels were transferred to PVDF membranes using a Trans-Blot® Turbo™ Transfer
670 Starter System (BioRad) at 25 mA for 15 minutes. Blots were blocked for 2 hours with Casein solution in
671 tris buffered saline (10 mM Tris HCl containing 15 mM NaCl) and 0.05% Tween 20 (TBST) to reduce
672 non-specific reactions. Affinity purified polyclonal primary antibody raised against a specific peptide
673 epitope on lipovitellin light chain of zebrafish Vtg3 (anti-zfLvL3, GeneScript Custom Antibody
674 production Service, USA) was employed to detect Vtg3 or its product yolk proteins in liver, ovary and

675 eggs from F3 *vgt3*-KO zebrafish. For this purpose, blots were incubated for 2 h at room temperature with
676 the anti-zfLvL3 at a 1:000 dilution in phosphate buffered saline (10 mM Na₂HPO₄, pH 7.5, 150 mM
677 NaCl). Membranes were washed three times for 5 minutes in TBST solution and incubated in biotinylated
678 goat anti-rabbit IgG affinity purified secondary antibody diluted 1:8000 in casein solution for 30 minutes
679 at room temperature. Membranes were washed in TBST solution three times for 5 minutes each and
680 incubated in VECTASTAIN® ABC-AmP™ reagent (VECTASTAIN ABC-AmP Kit, for Rabbit IgG,
681 Chemiluminescent Western Blot Detection, Vector Laboratories) for 10 minutes at room temperature.
682 Following three washes of 5 minutes in TBST, membranes were equilibrated in 0.1 M Tris buffer, pH 9.5
683 before development in DuoLuX™ Substrate (Vector Laboratories) and exposure to chemiluminescent
684 signal detection on FUSION-FX7 advanced chemiluminescence/fluorescence system (Vilber Lourmat,
685 Germany). In preliminary experiments performed to optimize concentrations of the second antibody
686 employing ovary samples from Wt fish, ‘no primary antibody’ control blots did not produce any signal,
687 verifying that detected immunoreactivity was due to the primary antibody (*data not shown*).

688

689 **4.8. Liquid Chromatography Tandem Mass Spectrometry**

690 Protein extraction of liver and egg samples from *vgt1*-KO, *vgt3*-KO and Wt female zebrafish
691 were done as described by Yilmaz et al. (2017). Briefly, samples were subjected to sonication in 20 mM,
692 pH 7.4, HEPES buffer on ice, soluble protein extracts were recovered following centrifugation (15 000 x
693 g) at +4 °C for 30 minutes and the remaining pellet was re-sonicated in 30 mM Tris / 8 M Urea / 4 %
694 CHAPS buffer on ice. Ultracentrifugation (105,000 xg) of the pooled protein extracts for 1 hour at 4 °C
695 was followed by supernatant recovery and determination of the protein concentration by Bradford Assay
696 (Bradford, 1976) (Bio-Rad, Marnes-la-Coquette, France). Samples of extracts were mixed with sample
697 buffer and DTT and denatured at 70 °C for 10 minute before being subjected to SDS-PAGE (60 µg
698 protein/sample lane). When protein samples had completely penetrated the stacking gel (~2 minutes at
699 200 V-400 mA (~23 W)), electrophoresis was stopped and gels were briefly rinsed in MilliQ ultrapure
700 water (Millipore S.A.S., Alsace, France) and then incubated in fixation solution containing 30 % EtOH /

701 10 % acetic acid / 60 % MilliQ water for 15 minutes in order to fix proteins on the gel. Gels were then
702 washed in MilliQ water three times for 5 min each and incubated in EZBlue™ Gel Staining Reagent
703 (Sigma-Aldrich, Saint-Quentin Fallavier, France) at room temperature with slight agitation for 2 hours,
704 and de-stained in MilliQ water at room temperature overnight. Subsequently, protein bands were excised
705 from the gel and the excised gel pieces were processed for tryptic digestion and peptide extraction as
706 indicated by Yilmaz et al. (2017). Once peptide extraction was completed, pellets containing digested
707 peptides were resolubilized in 30 µl of 95 % H₂O : 5 % formic acid by vortex mixing for 10 minutes and
708 diluted 10 times before being subjected to LC-MS/MS.

709 Peptide mixtures were analyzed using a nanoflow high-performance liquid chromatography
710 (HPLC) system (LC Packings Ultimate 3000, Thermo Fisher Scientific, Courtaboeuf, France) connected
711 to a hybrid LTQ-Orbitrap XL spectrometer (Thermo Fisher Scientific) equipped with a nanoelectrospray
712 ion source (New Objective), as previously described (Lavigne et al., 2012; Yilmaz et al., 2017). The
713 spectra search, protein identification, quantification by spectral counts, and spectral count normalization
714 were conducted as described by Yilmaz et al. (2017). To detect significant differences between group
715 mean N-SC values (*vtg1*-KO vs Wt or *vtg3*-KO vs Wt) for different zebrafish Vtgs from liver and eggs,
716 an independent samples Kruskal-Wallis nonparametric test ($p < 0.05$) followed by Benjamini Hochberg
717 correction for multiple tests ($p < 0.1$) was used (IBM SPSS Statistics Version 19.0.0, Armonk, NY).

718

719 **4.9. Ethical Statement**

720 All experiments complied with French & European regulations ensuring 'animal welfare' and that
721 'Animals will be held in the INRA UR1037 LPGP fish facility (DDCSPP approval # B35-238-6).'

722 Experimental protocols involving animals were approved by the Comité Rennais d'éthique pour
723 l'expérimentation animale (CREEA).

724

725

726 **5. COMPETING INTERESTS**

727 Authors declare no competing interests.

728

729

730 **6. FUNDING**

731 This study was supported by the Region Bretagne in France (SAD-2013)-FishEgg (8210); Project
732 #13009218), the EC-Marie Skłodowska-Curie Actions within the frame of the IEF program (FP7-
733 PEOPLE-2013-IEF; FISHEGG: Project # 626272) and Maternal Legacy (ANR-13-BSV7-0015).

734

735

736 **7. ACKNOWLEDGMENTS**

737 Authors would like to thank Dr. Amaury Herpin and Dr. Amine Bouchareb for their advice in
738 development of methodological strategies, and Dr. Craig V. Sullivan for his valuable contribution in
739 reviewing and evaluating the manuscript.

740

741

742 **8. REFERENCES**

743 Alix, M., Zarski, D., Chardard, D., Fontaine, P., Schaerlinger, B. (2017). Deformities in newly hatched
744 embryos of Eurasian perch populations originating from two different rearing systems. *Journal of*
745 *Zoology*, 302,126-137.

746 Altschul, S.F., Gish, W., Miller, W., Myers, E.W., Lipman, D.J. (1990). Basic local alignment search
747 tool. *Journal of Molecular Biology*, 215, 403-410.

748 Andersen, Ø., Xu, C., Timmerhaus, G., Kirste, K.H., Naeve, I., Mommens, M., Tveiten, H. (2017).
749 Resolving the complexity of vitellogenins and their receptors in the tetraploid Atlantic salmon (*Salmo*
750 *salar*): ancient origin of the phosvitin-less VtgC in chondrichthyeen fishes. *Molecular Reproduction*
751 *and Development*, 84(11), 1191–1202.

752 Babin, P.J., Carnevali, O., Lubzens, E., Schneider, W.J. (2007). Molecular aspects of oocyte
753 vitellogenesis in fish. In: Babin, P.J., Cerdà, J., Lubzens, E. (Eds.), *The Fish Oocyte: From Basic*
754 *Studies to Biotechnological Applications*. Springer, Dordrecht, pp. 39–76.

755 Babin, P.J. (2008). Conservation of a vitellogenin gene cluster in oviparous vertebrates and identification
756 of its traces in the platypus genome. *Gene*, 413, 76–82.

757 Bhattacharya, D., Sarkar, S., Juim, S.K., Nath, P. (2018). Induction of fertilizable eggs by conspecific
758 vitellogenin implantation in captive female walking catfish, *Clarias batrachus*. *Aquaculture Research*,
759 49, 3167-3175.

760 Bradford, M.M. (1976). A rapid and sensitive method for the quantitation of microgram quantities of
761 protein utilizing the principle of protein-dye binding. *Analytical Biochemistry*, 72, 248-254.

762 Carnevali, O., Centonze, F., Brooks, S., Marota, I., Sumpter, J.P. (1999a) Molecular cloning and
763 expression of ovarian cathepsin D in seabream, *Sparus aurata*. *Biology of Reproduction*, 66, 785–791.

764 Carnevali, O., Carletta, R., Cambi, A., Vita, A., Bromage, N. (1999b). Yolk formation and degradation
765 during oocyte maturation in seabream, *Sparus aurata*: involvement of two lysosomal proteinases.
766 *Biology of Reproduction*, 60, 140–146.

767 Carnevali, O., Cionna, C., Tosti, L., Lubzens, E., Maradonna, F. (2006). Role of cathepsins in ovarian
768 follicle growth and maturation. *General and Comparative Endocrinology*, 146, 195–203.

769 Cerdà, J., Fabra, M., Raldúa, D. (2007). Physiological and molecular basis of fish oocyte hydration. In:
770 Babin, P.J., Cerdà, J., Lubzens, E. (Eds.), *The Fish Oocyte: From Basic Studies to Biotechnological*
771 *Applications*. Springer, Dordrecht, pp. 349–396.

772 Cerdà, J., Zapater, C., Chauvigné, F., Finn, R.N. (2013). Water homeostasis in the fish oocyte: new
773 insights into the role and molecular regulation of a teleost-specific aquaporin. *Fish Physiology and*
774 *Biochemistry*, 39, 19–27.

775 Costa, R.S., de Souza, F.M.S., Senhorini, J.A., Veríssimo-Silveira, R., Ninhaus-Silveira, A. (2017).
776 Effects of cryoprotectants and low temperatures on hatching and abnormal embryo development of
777 *Prochilodus lineatus* (Characiformes: Prochilodontidae). *Neotropical Ichthyology*, 15, e170043.

778 Doudna, J.A., Charpentier, E. (2014). The new frontier of genome engineering with CRISPR-Cas9.
779 *Science* 346, 6213; DOI: 10.1126/science.1258096.

780 Ellis, T.R., Crawford, B.D. (2016). Experimental dissection of metalloproteinase inhibition-mediated and
781 toxic effects of phenanthroline on zebrafish development. *International Journal of Molecular*
782 *Sciences*, 17, 1503 DOI:10.3390/ijms17091503.

783 Finn, R.N. (2007). The maturational disassembly and differential proteolysis of paralogous vitellogenins
784 in a marine pelagophil teleost: A conserved mechanism of oocyte hydration. *Biology of Reproduction*,
785 76, 936-948.

786 Finn, R.N., Kristoffersen, B.A. (2007). Vertebrate vitellogenin gene duplication in relation to the “3R
787 hypothesis”: correlation to the pelagic egg and the oceanic radiation of teleosts. *PLoS One*, 2(1):e169.

788 Finn, R.N., Kolarevic, J., Kongshaug, H., Nilsen, F. (2009). Evolution and differential expression of a
789 vertebrate vitellogenin gene cluster. *BMC Evolutionary Biology*, 9:2.

790 Finn, R.N., Fyhn, H.J. (2010). Requirement for amino acids in ontogeny of fish. *Aquaculture Research*,
791 41, 684-716.

792 Flouriot, G., Pakdel, F., Valotaire, Y. (1996). Transcriptional and post-transcriptional regulation of
793 rainbow trout estrogen receptor and vitellogenin gene expression. *Molecular and Cellular*
794 *Endocrinology*, 124, 173-183.

795 Gabor, K.A., Goody, M.F., Mowel, W.K., Breitbach, M.E., Gratacap, R.L. Witten, P.E., Kim, C.H.
796 (2014). Influenza A virus infection in zebrafish recapitulates mammalian infection and sensitivity to
797 anti-influenza drug treatment. *Disease Models and Mechanisms*, 7, 1227-1237.

798 Hanke, N., Staggs, L., Schroder, P., Litteral, J., Fleig, S., Kaufeld, J., Pauli, C., Haller, H., Schiffer, M.
799 (2013). “Zebrafishing” for Novel Genes Relevant to the Glomerular Filtration Barrier. *BioMed*
800 *Research International*, 658270; <http://dx.doi.org/10.1155/2013/658270>.

801 Hiramatsu, N., Hara, A., Hiramatsu, K., Fukada, H., Weber G.M., Denslow, N.D., Sullivan, C.V. (2002).
802 Vitellogenin-derived yolk proteins of white perch, *Morone americana*: Purification, characterization,
803 and vitellogenin-receptor binding. *Biology of Reproduction*, 67, 655-667.

804 Hiramatsu, N., Cheek, A.O., Sullivan, C.V., Matsubara, T., Hara, A. (2005). Vitellogenesis and endocrine
805 disruption. In: Mommsen, T.P., Moon, T. (Eds.), *Biochemistry and Molecular Biology of Fishes,*
806 *Environmental Toxicology* Vol. 6. 2005; Elsevier Science Press, Amsterdam, The Netherlands, pp.
807 431–471 (Chapter 16, 562 pp).

808 Hiramatsu, N., Todo, T., Sullivan, C.V., Schilling, J., Reading, B., Matsubara, T., Ryu, Y-W., Mizuta, H.,
809 Luo, W., Nishimiya, O., Wu, M., Mushirobira, Y., Yilmaz, O., Hara, A. (2015). Ovarian yolk
810 formation in fishes: molecular mechanisms underlying formation of lipid droplets and vitellogenin-
811 derived yolk proteins. *General and Comparative Endocrinology*, 221, 9-15.

812 Hyams, G., Abadi, S., Lahav, S., Avni, A., Halperin, E., Shani, E., Mayrose, I. (2018). CRISPyS: Optimal
813 sgRNA design for editing multiple members of a gene family using the CRISPR system. *Journal of*
814 *Molecular Biology*, 430, 2184-2195.

815 Juin, S.K., Mukhopadhyay, B.C., Biswas, S.R., Nath, P. (2017). Conspecific vitellogenin induces the
816 expression of vg gene in the Indian male walking catfish, *Clarias batrachus* (Linn.). *Aquaculture*
817 *Reports*, 6, 61-67.

818 Kimmel, C.B., Ballard, W.W., Kimmel, S.R., Ullmann, B., Schilling, T. (1995). Stages of embryonic
819 development of the zebrafish. *Developmental Dynamics*, 203, 253-310.

820 Krøvel, A.V., Olsen, L.C. (2002). Expression of a vas::EGFP transgene in primordial germ cells of the
821 zebrafish. *Mechanisms of Development*, 116, 141-150.

822 Laemmli, U.K. (1970). Cleavage of structural proteins during the assembly of the head of bacteriophage
823 T4. *Nature*, 227, 680–685.

824 Lavigne, R., Becker, E., Liu, Y., Evrard, B., Lardenois, A., Primig, M., Pineau, C. (2012). Direct iterative
825 protein profiling (DIPP)-an innovative method for large-scale protein detection applied to budding
826 yeast mitosis. *Molecular and Cellular Proteomics*, 11, M111-012682.

827 Levi, L., Pekarski, I., Gutman, E., Fortina, P., Hyslop, T., Biran, J., Levavi-Sivan, B., Lubzens, E. (2009).
828 Revealing genes associated with vitellogenesis in the liver of the zebrafish (*Danio rerio*) by
829 transcriptome profiling. *BMC Genomics*, 10:141. [http://dx. doi.org/10.1186/1471-2164-10-141](http://dx.doi.org/10.1186/1471-2164-10-141).

830 Levi, L., Ziv, T., Admon, A., Levavi-Sivan, B., Lubzens, E. (2012). Insight into molecular pathways of
831 retinal metabolism, associated with vitellogenesis in zebrafish. *American Journal of Physiology-*
832 *Endocrinology and Metabolism*, 302, E626–E644.

833 Li, A., Sadasivam, M., Ding, J.L. (2003). Receptor–ligand interaction between vitellogenin receptor
834 (VtgR) and vitellogenin (Vtg), implications on low density lipoprotein receptor and apolipoprotein
835 B/E. The first three ligand binding repeats of VtgR interact with the amino-terminal region of Vtg. *The*
836 *Journal of Biological Chemistry*, 278, 2799–2806.

837 Liu, H., Sui, T., Liu, D., Liu, T., Chen, M., Deng, J., Xu, Y., Li, Z. (2018). Multiple homologous genes
838 knockout (KO) by CRISPR/Cas9 system in rabbit. *Gene*, 647, 261–267.

839 Lubzens, E., Bobe, J., Young, G., Sullivan, C.V. (2017). Maternal investment in fish oocytes and eggs:
840 The molecular cargo and its contributions to fertility and early development. *Aquaculture*, 472, 107-
841 143.

842 Marschang, P., Brich, J., Weeber, E.J., Sweatt, J.D., Shelton, J.M., Richardson, J.A., Hammer, R.E., Herz,
843 J. (2004). Normal development and fertility of knockout mice lacking the tumor suppressor gene
844 LRP1b suggests functional compensation by LRP1. *Molecular and Cellular Biology*, 24,3782-3793.

845 Matsubara, T., Koya, Y. (1997). Course of proteolytic cleavage in three classes of yolk proteins during
846 oocyte maturation in barfin flounder, *Verasper moseri*, a marine teleost spawning pelagic eggs.
847 *Journal of Experimental Zoology*, 278, 189-200.

848 Matsubara, T., Ohkubo, N., Andoh, T., Sullivan, C.V., Hara, A. (1999). Two forms of vitellogenin,
849 yielding two distinct lipovitellins, play different roles during oocyte maturation and early development
850 of barfin flounder, *Verasper moseri*, a marine teleost spawning pelagic eggs. *Developmental Biology*,
851 213, 18–32.

852 Matsubara, T., Nagae, M., Ohkubo, N., Andoh, T., Sawaguchi, S., Hiramatsu, N., Sullivan, C.V., Hara, A.
853 (2003). Multiple vitellogenins and their unique roles in marine teleosts. *Fish Physiology and*
854 *Biochemistry*, 28, 295–29.

855 Nelson, E.R., Habibi, H.R. (2013). Estrogen receptor function and regulation in fish and other vertebrates.
856 *General and Comparative Endocrinology*, 192, 15–24. <http://dx.doi.org/10.1016/j.ygcen.2013.03.032>.

857 Opresko, L.K., Wiley, H.S. (1987). Receptor-mediated endocytosis in *Xenopus* oocytes: I-
858 Characterization of vitellogenin receptor system. *The Journal of Biological Chemistry*, 262, 4109-
859 4115.

860 Ottesen, O.H., Bolla, S. (1998). Combined effects of temperature and salinity on development and
861 survival of Atlantic halibut larvae. *Aquaculture International*, 6, 103-120.

862 Patiño, R., Sullivan, C.V. (2002). Ovarian follicle growth, maturation and ovulation in teleost fish. *Fish*
863 *Physiology and Biochemistry*, 26, 57–70.

864 Prykhozhij, S.V., Rajan, V., Gaston, D., Berman, J.N. (2015). CRISPR MultiTargeter: A web tool to find
865 common and unique CRISPR single guide RNA targets in a set of similar sequences. *PLoS ONE*,
866 10(3): e0119372. doi:10.1371/journal.pone.0119372.

867 Reading, B.J., Hiramatsu, N., Sawaguchi, S., Matsubara, T., Hara, A., Lively, M.O., Sullivan, C.V.
868 (2009). Conserved and variant molecular and functional features of multiple vitellogenins in white
869 perch (*Morone americana*) and other teleosts. *Marine Biotechnology*, 11, 169–187.

870 Reading, B.J., Sullivan, C.V. (2011). The Reproductive Organs and Processes - Vitellogenesis in Fishes,
871 Editor: Anthony P. Farrell, Encyclopedia of Fish Physiology, Academic Press, pp 635-646,
872 <https://doi.org/10.1016/B978-0-12-374553-8.00257-4>.

873 Reading, B.J., Sullivan, C.V., Schilling, J. (2017). Vitellogenesis in fishes. Reference Module in Life
874 Sciences, Elsevier, <https://doi.org/10.1016/B978-0-12-809633-8.03076-4>.

875 Reis-Henriques, M.A., Cruz, M.M., Periera, J.O. (1997). The modulating effect of vitellogenin on the
876 synthesis of 17 β -estradiol by rainbow trout (*Oncorhynchus mykiss*) ovary. *Fish Physiology and*
877 *Biochemistry*, 16, 181-186.

878 Reis-Henriques, M.A., Ferriera, M., Silva, L., Dias, A. (2000). Evidence for an involvement of
879 vitellogenin in the steroidogenic activity of rainbow trout (*Oncorhynchus mykiss*) vitellogenic oocytes.
880 *General and Comparative Endocrinology*, 117, 260-267.

881 Reith, M., Munholland, J., Kelly, J., Finn, R.N., Fyhn, H.J. (2001). Lipovitellins derived from two forms
882 of vitellogenin are differentially processed during oocyte maturation in haddock (*Melanogrammus*
883 *aeglefinus*). *Journal of Experimental Zoology*, 291, 58–67.

884 Ren, L., Lewis, S.K., Lech, J.J. (1996). Effects of estrogen and nonylphenol on the post-transcriptional
885 regulation of vitellogenin gene expression. *Chemico-Biological Interactions*, 100, 67-76.

886 Ribas, L., Piferrer, F. (2013). The zebrafish (*Danio rerio*) as a model organism, with emphasis on
887 applications for finfish aquaculture research. *Reviews in Aquaculture*, 5, 1-32.

888 Sander, J.D., Zaback, P.Z., Joung, J.K., Voytas, D.F., Dobbs, D. (2007). Zinc Finger Targeter (ZiFiT): an
889 engineered zinc finger/target site design tool. *Nucleic Acids Research*, 35, W599-605.

890 Sander, J.D., Maeder, M.L., Reyon, D., Voytas, D.F., Joung, J.K., Dobbs, D. (2010). ZiFiT (Zinc Finger
891 Targeter): an updated zinc finger engineering tool. *Nucleic Acids Research*, 38, W462-468.

892 Sawaguchi, S., Ohkubo, N., Koya, Y., Matsubara, T. (2005). Incorporation and utilization of multiple
893 forms of vitellogenin and their derivative yolk proteins during vitellogenesis and embryonic
894 development in the mosquitofish, *Gambusia affinis*. *Zoological Sciences*, 22, 701-710.

895 Sawaguchi, S., Ohkubo, N., Matsubara, T. (2006a). Identification of two forms of vitellogenin-derived
896 phosvitin and elucidation of their fate and roles during oocyte maturation in the barfin flounder,
897 *Verasper moseri*. *Zoological Sciences*, 23, 1021-1029.

898 Sawaguchi, S., Kagawa, H., Ohkubo, N., Hiramatsu, N., Sullivan, C.V., Matsubara, T. (2006b).
899 Molecular characterization of three forms of vitellogenin and their yolk protein products during oocyte
900 growth and maturation in red seabream (*Pagrus major*), a marine teleost spawning pelagic eggs.
901 *Molecular Reproduction and Development*, 73, 719-736.

902 Sievers, F., Wilm, A., Dineen, D.G., Gibson, T.J., Karplus, K., Li, W., Lopez, R., McWilliam, H.,
903 Remmert, M., Söding, J., Thompson, J.D., Higgins, D. (2011). Fast, scalable generation of high
904 quality protein multiple sequence alignments using Clustal Omega. *Molecular Systems Biology*, 7, 5-
905 39. doi: 10.1038/msb.2011.75.

906 Sullivan, C.V., Yilmaz, O. (2018). Vitellogenesis and yolk proteins, fish. Editor: Michael K. Skinner,
907 Encyclopedia of Reproduction (Second Edition), Academic Press, pp 266-277,
908 <https://doi.org/10.1016/B978-0-12-809633-8.20567-0>.

909 Sun, B., Pankhurst, N.W. (2006). In vitro effect of vitellogenin on steroid production by ovarian follicles
910 of greenback flounder, *Rhombosolea tapirina*. *Comparative Biochemistry and Physiology Part A*, 144,
911 75-85.

912 Sztal, T.E., McKaige, E.A., Williams, C., Ruparelia, A.A., Bryson-Richardson, R.J. (2018). Genetic
913 compensation triggered by actin mutation prevents the muscle damage caused by loss of actin protein.
914 *PLoS Genetics*, 14: e1007212.

915 Thorsen, A., Fyhn, H.J. (1996). Final oocyte maturation in vivo and in vitro in marine fishes with pelagic
916 eggs; yolk protein hydrolysis and free amino acid content. *Journal of Fish Biology*, 48, 1195–1209.

917 Trubiroha, A., Gillotay, P., Giusti, N., Gacquer, D., Libert, F., Lefort, A., Haerlingen, B., De Deken, X.,
918 Opitz, R., Costagliola, S. (2018). A Rapid CRISPR/Cas-based Mutagenesis Assay in Zebrafish for
919 Identification of Genes Involved in Thyroid Morphogenesis and Function. *Scientific Reports*, 8, 5647
920 <https://doi.org/10.1038/s41598-018-24036-4>.

921 Tsuruwaka, Y., Konishi, M., Shimada, E. (2015). Loss of wwox expression in zebrafish embryos causes
922 edema and alters Ca²⁺ dynamics. *PeerJ*, 3: e727; DOI 10.7717/peerj.727.

923 Xie, S-L., Bian, W-P., Wang, C., Junaid, M., Zou, J-X., Pei, D-S. (2016). A novel technique based on in
924 vitro oocyte injection to improve CRISPR/Cas9 gene editing in zebrafish. *Scientific Reports*, 6, 34555;
925 doi: 10.1038/srep34555 (2016).

926 Yang, J., Li, Z., Gan, X., Zhai, G., Gao, J., Xiong, C., Qiu, X., Wang, X., Yin, Z., Zheng, F. (2016).
927 Deletion of Pr130 Interrupts Cardiac Development in Zebrafish. *International Journal of Molecular*
928 *Sciences*, 17: 1746; doi:10.3390/ijms17111746.

929 Yilmaz, O., Prat, F., Ibáñez, J.A., Koksoy, S., Amano, H., Sullivan, C.V. (2016). Multiple vitellogenins
930 and product yolk proteins in European sea bass (*Dicentrarchus labrax*): Molecular characterization,

931 quantification in plasma, liver and ovary, and maturational proteolysis. *Comparative Biochemistry and*
932 *Physiology Part B*, 194, 71–86.

933 Yilmaz, O., Patinote, A., Nguyen, T., Com, E., Lavigne, R., Pineau, C., Sullivan, C.V., Bobe, J. (2017).
934 Scrambled eggs: Proteomic portraits and novel biomarkers of egg quality in zebrafish (*Danio rerio*).
935 *PLoS ONE*, 12: e0188084. <https://doi.org/10.1371/journal.pone.0188084>.

936 Yilmaz, O., Patinote, A., Nguyen, T., Bobe, J. (2018). Multiple vitellogenins in zebrafish (*Danio rerio*):
937 quantitative inventory of genes, transcripts and proteins, and relation to egg quality. *Fish Physiology*
938 *and Biochemistry*, <https://doi.org/10.1007/s10695-018-0524-y> (Epub ahead of print).

939 Zhang, X., Lin, Q., Ren, F., Zhang, J., Dawar, F.U., Mei, J. (2018). The dysregulated autophagy signaling
940 is partially responsible for defective podocyte development in wt1a mutant zebrafish. *Aquaculture and*
941 *Fisheries*, 3, 99-105.

942
943
944

945 9. FIGURE LEGENDS

946 **Fig 1. Schematic representation of the general strategy for CRISPR target design in the zebrafish**
947 **vitellogenin gene (*vtg*) knock out (KO) study. A)** Syntenic organization of multiple *vtg* genes. The
948 genomic locations for *vtg* genes and neighboring genes are shown. Polygons indicate individual genes and
949 show their available transcriptional orientation, with abbreviated gene names appearing above; different
950 colors indicate different types of zebrafish *vtg* with red, blue, and yellow indicating zebrafish type-I, type
951 -II, and type-III vtgs, respectively (gray indicates genes other than *vtgs*). Chr, chromosome. (from Yilmaz
952 et al., 2018). **B)** Type-I *vtg* knock out (*vtg1-KO*). **C)** Type-III *vtg* knock out (*vtg3-KO*). Schematic
953 representations of the intron/exon structure of zebrafish type-I *vtgs* and *vtg3* in 5' to 3' direction indicated
954 by triangles on the left pointing to the right are given in panels **B** and **C**, respectively. Horizontal line
955 segments indicate introns and filled gold boxes indicate exons. Exons bearing CRISPR/Cas9 target

956 sequences (sg11, sg12, and sg13 for type-I *vtgs*; sg31, sg32, and sg33 for *vtg3*) are indicated by large blue
957 arrowheads pointing upwards.

958

959

960

961

962 **Fig 2. Mutations introduced by CRISPR/Cas9 in predicted polypeptide sequences of the targeted**

963 **zebrafish *vtgs*.** Yolk protein domain models of Vtg1 (representative of zebrafish type-I Vtgs) and Vtg3

964 are pictured in 5' > 3' orientation above each panel. Contiguous white horizontal bars represent

965 lipovitellin heavy and light chain (LvH, LvL) and phosvitin (Pv) domains of the respective Vtg (Vtg3

966 lacks a Pv domain) that are labeled above by their abbreviations in large bold type. Sequences within

967 these bars set in normal type represent the N-terminus of each yolk protein domain, the starting points of

968 which are indicated, when present, by vertical bars in the predicted polypeptide sequences shown below.

969 Sequences arising from 5' > 3' translation (frame 1) were predicted by the ExPASy translate tool

970 (available online at <https://web.expasy.org/translate/>). The predicted products of open reading frames are

971 highlighted in light gray. Start codon products (methionine, **M**) are shown in bold green type and stop

972 codons are indicated by red dashed lines (-). The locations of deletions introduced by CRISPR/Cas9 are

973 indicated by magenta text showing the number of deleted amino acids (aa) flanked by angle brackets.

974 Residues encoded by nucleotide sequences targeted by sgRNAs for Cas9 editing are framed in blue-

975 shaded boxes. Short sequences that were employed as epitopes to develop Vtg domain-specific antibodies

976 against zebrafish (zf) Vtg1-LvH (anti-zfLvH1) and Vtg3-LvL (anti-zfLvL3) are indicated by boxed text

977 in the respective LvH and LvL sequences, with their location also highlighted by black arrows labeled

978 with the epitope names in vertically-oriented text in the panel margins. The 85-residue Vtg receptor-

979 binding domain (***RbD***) and the critical 8-residue Vtg receptor-binding motif (***RbM***) located within this

980 domain, which were identified by Li et al. (2003) in the LvH domain of blue tilapia (*Oreochromis aureus*)

981 VtgAb, are shown in the polypeptide sequences in boldface italic type. The ***RbM*** sequence is additionally

982 underlined and also shown in the yolk protein domain map above. The location of these sequences is
983 highlighted by black arrows labeled with **RbD/RbM** as vertically-oriented text in the panel margins. For
984 *vtg1*-KO (panel A), the diagram below the yolk protein domain model shows the relative location of the
985 234 aa deletion introduced by CRISPR/Cas9 (double headed magenta arrow), the frameshift induced by
986 this deletion (left pointing blue arrow), the first premature stop codon arising from this frameshift (single
987 red dash), the 529 aa sequence product of the contiguous open reading frame terminating at this stop
988 codon (right pointing black arrow), and the remaining broken sequence interrupted by multiple stop
989 codons (right pointing red and black dashed arrow). For *vtg3*-KO (panel B), the diagram below the yolk
990 protein domain model employs similar color coding and shows the relative position of the in-frame 238 aa
991 deletion, the single stop codon terminating the sequence, and the 999 aa sequence product of the
992 contiguous open reading frame.

993
994 **Fig 3. Detection of CRISPR/Cas9-introduced mutations by embryo genotyping and production of**
995 **F4 generation *vtg*-KO mutants.** Left and middle panels illustrate genotyping of embryos at 24 hours
996 post-fertilization (hpf) by PCR for the *vtg1*-KO (representative of zebrafish type-I *vtgs*) and *vtg3*-KO
997 lines, respectively, from the F0 to F4 generation. Target sites are shown by blue colored arrows labeled as
998 sg followed by 1, 2 or 3 indicating the targeted zebrafish *vtg* type and the number of the target site (i.e.
999 sg11, sg12, and sg13: single guide RNAs (sgRNAs) for target sites 1, 2, and 3 for *vtg1*, respectively.
1000 sg31, sg32, and sg33: sgRNAs for target sites 1, 2, and 3 for *vtg3*, respectively). Arrows are oriented to
1001 indicate the sense/antisense orientation of each target. Numbers above each target site specify its exact
1002 location by nucleotide in the genomic sequence of the zebrafish *vtgs*. Primers used in screening for
1003 introduced mutations by PCR are shown as gray arrowheads outlined in black, which are oriented to
1004 indicate the sense/antisense orientation of the primer. Numbers below each primer site indicate its exact
1005 position by nucleotide in the genomic sequence of the targeted gene (see also **S1 Fig A-B**). Horizontal
1006 brackets below indicate areas screened for mutations by PCR using selected primer combinations. Text
1007 below the brackets indicates the primer pair followed by the size of the band (bp) expected for wild type

1008 gDNA in agarose gel electrophoresis. 11Fw, *vtg1* target1 forward primer; 12Rv, *vtg1* target2 reverse
1009 primer; 13Rv, *vtg1* target3 reverse primer; 12Fw, *vtg1* target2 forward primer; 31Fw, *vtg3* target1 forward
1010 primer; 32Rv, *vtg3* target2 reverse primer; 33Rv, *vtg3* target3 reverse primer; 32Fw, *vtg3* target2 forward
1011 primer. Primer sequences are given in **S1 Table**. F0 indicates the generation reared from microinjected
1012 embryos and F1-4 represent offspring raised from each subsequent generation. The agarose gel
1013 electrophoresis results shown here represent screening of 10 randomly sampled embryos as
1014 representatives of their generations and two additional wild type embryos as controls. Bands comprised of
1015 wild type intact gDNA (*wild type*: 3642 bp and 1733 bp for *vtg1* and *vtg3*, respectively) and mutated
1016 gDNA (*mutated*: 2361 bp and 551 bp for *vtg1*-KO and *vtg3*-KO, respectively) are shown and highlighted
1017 by black arrowheads on the right side of each panel. Open circles; non-related wild type fish (Wt)
1018 carrying intact (*vtg1*+/+ or *vtg3*+/+) genomic DNA. Open diamonds; sibling wild type individuals, which
1019 do not carry the desired mutation in either allele (*vtg1*+/+ or *vtg3*+/+) of their gDNA. Open triangles;
1020 heterozygous (Ht) individuals carrying the introduced mutation on only a single allele (*vtg1*-/+ or *vtg3*-/+)
1021 in their genomic DNA. Asterisks; homozygous embryos (Hm) carrying the introduced mutation in both
1022 alleles (*vtg1*-/- or *vtg3*-/-) of their genomic DNA. The panel on the far right illustrates the general strategy
1023 followed to establish pure zebrafish lines bearing the desired Cas9 introduced mutation. This process
1024 involved stepwise reproductive crosses (indicated by X) between males (♂) and females (♀) indicated
1025 here with zebrafish icons. F0-4 represents the zebrafish generations produced in the process. Images of
1026 sub-adult fish are shown for simplicity at generation F4; all or most of these fish were actually inviable
1027 and did not survive past early developmental stages (see text for details).

1028
1029 **Fig 4. Relative quantification of *vtg* gene expression in *vtg*-KO zebrafish female liver. A)** Comparison
1030 of gene expression levels for all *vtgs* in F3 *vtg1*-KO female liver (Hm, homozygous; Ht, heterozygous;
1031 wt, sibling wild type) versus non-related wild type female liver (Wt). TaqMan qPCR-2^{-ΔΔCT} mean relative
1032 quantification of gene expression was employed using zebrafish 18S ribosomal RNA (*18S*) as the
1033 reference gene. Data were statistically analyzed using a Kruskal Wallis nonparametric test p<0.05

1034 followed by Benjamini Hochberg corrections for multiple tests $p < 0.1$. **B)** Comparison of gene expression
1035 levels for all *vtgs* in F3 *vtg3*-KO female liver (Hm, Ht and wt) versus Wt female liver. SYBR Green
1036 qPCR-2^{- $\Delta\Delta$ CT} mean relative quantification of gene expression normalized to the geometric mean
1037 expression of zebrafish elongation factor 1a (*ef1a*), ribosomal protein L13a (*rpl13a*) and *18S* was
1038 employed. Data were statistically analyzed using a Kruskal Wallis nonparametric test $p < 0.05$ followed by
1039 Benjamini Hochberg corrections for multiple tests $p < 0.1$. In the box plots, the centerlines indicate the
1040 median for each data set, upper boxes indicate the difference of the 3rd quartile from the median, lower
1041 boxes indicate the difference of the 1st quartile from the median. Top whiskers indicate difference of the
1042 maximum value from the 3rd quartile and the bottom whiskers indicate the difference of the minimum
1043 values from the 1st quartile in each data set. In both panels, numbers below x-axis labels indicate sample
1044 size and lowercase letters above the error bars represent significant differences between means ($p < 0.05$).
1045 For box plots sharing a common letter superscript, the means are not significantly different.

1046
1047 **Fig 5. Relative quantification of multiple vitellogenins by LC-MS/MS in *vtg*-KO zebrafish female**
1048 **liver and eggs.** **A)** Comparisons of mean normalized spectral counts (N-SC) for Vtg protein levels in Wt
1049 versus Hm F3 *vtg1*-KO female zebrafish livers and in eggs obtained from these females, indicated by dark
1050 and light gray vertical bars, respectively. Vertical brackets indicate SEM. **B)** Corresponding comparison
1051 of N-SC for Vtg protein levels in Wt versus F3 Hm *vtg3*-KO female zebrafish livers and in eggs obtained
1052 from these females. Asterisks indicate statistically significant differences between group means detected
1053 by an independent samples Kruskal Wallis non-parametric test ($p < 0.05$) followed by Benjamini Hochberg
1054 correction for multiple tests ($p < 0.1$)

1055
1056 **Fig 6. Detection of Vtg3 in *vtg3*-KO versus wild type female liver, ovary and eggs by Western**
1057 **blotting.** An affinity-purified, polyclonal anti-zfLvL3 antibody was employed to detect LvL3 in this
1058 experiment. Numbers on the left of each panel indicate the mass of molecular weight marker proteins
1059 (kDa). M, marker protein ladder; Hm, homozygous; Ht, heterozygous; Wt, non-related wild type. Bands

1060 that were detected in Ht and Wt zebrafish, but not Hm zebrafish, whose mass corresponds to LvL derived
1061 from zebrafish (zf) Vtg3 are indicated by horizontal brackets with labels immediately underneath (zf
1062 LvL3, ~24 kDa).

1063

1064 **Fig 7. Phenotypic measurements of F3 *vtg*-KO females and their F4 progeny.** Bar graphs indicate
1065 mean values (\pm SEM) for measurements of each parameter and labels below the x-axes indicate the groups
1066 that were compared. Egg and embryo diameter measurements were taken in fertilized eggs at 2-3 hpf, egg
1067 diameter refers to the diameter of the chorion for each measured egg and embryo diameter refers to the
1068 embryo within the egg envelope. Larval size measurements were taken along the anteroposterior axis. In
1069 the panel at the bottom right, mean hatching percentages for Hm *vtg1*-KO, Hm *vtg3*-KO, and Wt eggs are
1070 shown as circles, triangles and diamonds, respectively. Numbers on the x-axis accompanied by dashed-
1071 and solid-lined arrows represent sampling times in hours or days post spawning, respectively. In all
1072 graphs, asterisks and black stars indicate mean values that are statistically significantly different from
1073 corresponding Wt mean values based upon results of an independent samples t-test ($p < 0.01$) followed by
1074 Benjamini Hochberg corrections for multiple tests in the case of hatching percentage ($p < 0.05$).

1075

1076 **Fig 8. Comparisons of survival percentages for homozygous F4 *vtg1*-KO and *vtg3*-KO zebrafish**
1077 **embryos and larvae versus wild type offspring.** Line plots represent mean survival percentages and
1078 numbers on the x-axis accompanied by dashed- and solid-lined arrows represent sampling times in hours
1079 or days post fertilization during the observation period. Mean survival percentages for Hm *vtg1*-KO, Hm
1080 *vtg3*-KO and unrelated Wt embryos and larvae at each time point are indicated by circles, triangles and
1081 diamonds, respectively, and vertical lines indicate SEM. Asterisks and black stars indicate mean values
1082 that are statistically significantly different from corresponding mean wild type (Wt) values based upon
1083 results of an independent samples t-test ($p < 0.01$) followed by Benjamini Hochberg corrections for
1084 multiple tests ($p < 0.05$).

1085

1086 **Fig 9. Observed phenotypes of F4 homozygous (Hm) *vtg*-KO offspring compared to wild type (Wt)**
1087 **offspring. A)** Hm *vtg1*-KO unhatched embryos and hatched larvae at 4 dpf. **B)** Dorsal view of Wt larva
1088 at 4 dpf. **C)** Lateral view of Wt larvae at 4 hpf. **D)** Hm *vtg3*-KO larvae at 4 dpf. **E)** Hm *vtg1*-KO larvae at
1089 8 dpf. **F)** Dorsal view of Wt larva at 8 dpf. **G)** Lateral view of Wt larva at 8 dpf. **H)** Hm *vtg3*-KO larvae at
1090 8 dpf. Special features of observed phenotypes are indicated by pointed arrows (see text for details). In all
1091 images, horizontal bars indicate 1000 μ m.

1092

1093

1094 **10. SUPPORTING INFORMATION LEGENDS**

1095

1096 **S1 Fig. Location and character of mutations introduced by CRISPR/Cas9 in zebrafish *vtgs*. A-B)**

1097 Location on genomic DNA. Schematic representations of the intron/exon structure of zebrafish *vtg1*
1098 (representative of type-I *vtgs*) and *vtg3* are given at the top of panels A and B, respectively. Horizontal
1099 line segments indicate introns and filled gold boxes indicate exons. Exons bearing CRISPR/Cas9 target
1100 sequences are indicated by large blue arrowheads pointing upwards to the target name (sg11, sg12, and
1101 sg13 for *vtg1*; sg31, sg32, and sg33 for *vtg3*). Horizontal dashed lines bearing dual arrowheads indicate
1102 regions where mutations were introduced, with the size of deletions in bp given below the arrows (1281
1103 bp and 1181 bp for *vtg1*-KO and *vtg3*-KO, respectively). The lower sections of panels A and B show
1104 Clustal Omega alignments for partial genomic sequences of the *vtg1* and *vtg3* genes, respectively,
1105 covering regions where Cas9 introduced targeted mutations. Sequences of undisturbed wild type alleles
1106 are labeled *vtg1*^{+/+} and *vtg3*^{+/+}, and sequences of homozygous mutated alleles are labeled *vtg1*^{-/-} and
1107 *vtg3*^{-/-}, respectively. Dashes were introduced to illustrate regions where deletions occurred in the *vtg1*^{-/-}
1108 and *vtg3*^{-/-}-sequences. Nucleotide positions are indicated by numbers on the right and asterisks indicate
1109 nucleotide identity. Target sequences are enclosed in blue-shaded boxes emphasized by blue arrowheads
1110 on the right. Intron sequences are given in dark gray font enclosed in light gray filled frames and are
1111 labeled by Intron on the right with the same formatting. Exons are shown in regular black font and labeled

1112 on the right with exon numbers (e.g. Exon 6, 7, 8...). Exons bearing the target sites are also labeled with
1113 the target name below in parenthesis (e.g. Exon 14 (sg12)). **C-D**) Location on mRNA. The deleted region
1114 of mRNA is indicated in the sequence by magenta text showing the number of deleted nucleotides (703
1115 bp *vtg1* and 714 bp for *vtg3*) enclosed by magenta angle brackets; flanking nucleotides that come together
1116 to form a new codon are underlined in magenta. **E-F**) Location on predicted cDNA. Nucleotide sequences
1117 targeted by sgRNAs for Cas9 editing and present in the predicted transcript are framed in blue-shaded
1118 boxes. The deleted region of the transcript is indicated in the sequence by magenta text showing the
1119 number of deleted nucleotides enclosed by magenta angle brackets, with flanking nucleotides that come
1120 together to form a new codon underlined in magenta (see also **S2 Fig**). The sequence encoding the Vtg
1121 receptor-binding domain (***RbD***) on the LvH of the respective Vtg (see **G-H**, below) is shown in italic
1122 typeface with the sequence encoding its critical, short receptor-binding motif (***RbM***) being additionally
1123 underlined. **G-H**) Location on predicted polypeptide sequence. Yolk protein domain models of Vtg1
1124 (representative of zebrafish type-I Vtgs) or Vtg3 are pictured in 5' > 3' orientation above each panel.
1125 Contiguous white horizontal bars represent lipovitellin heavy and light chain (LvH, LvL) and phosvitin
1126 (Pv) domains of the respective Vtg (Vtg3 lacks a Pv domain) that are labeled with their abbreviation
1127 above in large bold type. Sequences within these bars set in normal type represent the N-terminus of each
1128 yolk protein domain, the starting points of which are indicated, when present, by vertical bars in the
1129 predicted polypeptide sequences shown below. Predicted sequences arising from three frames of 5' > 3'
1130 translation performed using the Expasy translate tool (available online at
1131 <https://web.expasy.org/translate/>) are shown. Predicted products of open reading frames are highlighted in
1132 light gray, start codon products (methionine, **M**) are shown in bold green type, and stop codons are
1133 indicated by red dashed lines (-). The locations of deletions are indicated by magenta text showing the
1134 number of deleted amino acids (aa) enclosed by angle brackets. Residues encoded by nucleotide
1135 sequences targeted by sgRNAs for Cas9 editing are framed in blue-shaded boxes. Short sequences that
1136 were employed as epitopes to develop Vtg domain-specific antibodies against zebrafish (zf) Vtg1-LvH
1137 (anti-zfLvH1) and Vtg3-LvL (anti-zfLvL3) are indicated by boxed text in the respective LvH and LvL

1138 sequences, with their location also highlighted by black arrows labeled with the epitope names given by
1139 vertically-oriented text in the panel margins. The 85-residue Vtg receptor-binding domain (***RbD***) and the
1140 critical 8-residue Vtg receptor-binding motif (***RbM***) located within this domain, which were identified by
1141 Li et al. (2003) in the LvH domain of blue tilapia (*Oreochromis aureus*) VtgAb, are shown in the
1142 polypeptide sequences in boldface italic type, with the ***RbM*** sequence being additionally underlined and
1143 also shown in the yolk protein domain map above. The location of these sequences is also highlighted by
1144 black arrows labeled with **RbD/RbM** as vertically-oriented text in the panel margins. For *vtg1*-KO (panel
1145 G), the diagram below the yolk protein domain model shows the relative location of the 234 aa deletion
1146 introduced by CRISPR/Cas9 (double headed magenta arrow), the 529 aa sequence product of the
1147 contiguous open reading frame 1 (right pointing black arrow), which is terminated by a premature stop
1148 codon arising from a frameshift introduced by the deletion (see **Fig 2A**), and the 609 aa sequence product
1149 of the contiguous open reading frame 3 (right pointing blue arrow), which initiates just after the deletion.
1150 For *vtg3*-KO (panel H), the diagram below the yolk protein domain model employs the same symbols and
1151 color coding and shows the relative position of the in-frame 238 aa deletion introduced by CRISPR/Cas9
1152 (see **Fig 2B**), and the remaining 999 aa sequence product of the contiguous open reading frame 1.

1153
1154 **S2 Fig. Location and consequence of deletion mutations introduced by CRISPR/Cas9 into zebrafish**
1155 ***vtgs*. A) *vtg1*-KO.** The 703 bp deletion introduces a frame shift at residue 519, changing the codon
1156 without altering the encoded amino acid (isoleucine, I). This frame shift results in the appearance of a
1157 premature stop codon after 10 additional residues (not shown, see **Fig 2A** for details). **B) *vtg3*-KO.** The
1158 714 bp deletion alters the codon encoding residue 239, resulting in the substitution of leucine (L) for
1159 arginine (R) at this position, but it does not otherwise alter the remainder of the Vtg3 polypeptide (see **Fig**
1160 **2B**).

1161
1162 **S1 Table. Targets, primers and probes utilized in *vtg1*-KO and *vtg3*-KO studies.** Target oligo and screening
1163 primer names are given according Figure 1 and 3. CRISPR recognition NGG motifs are highlighted by bold

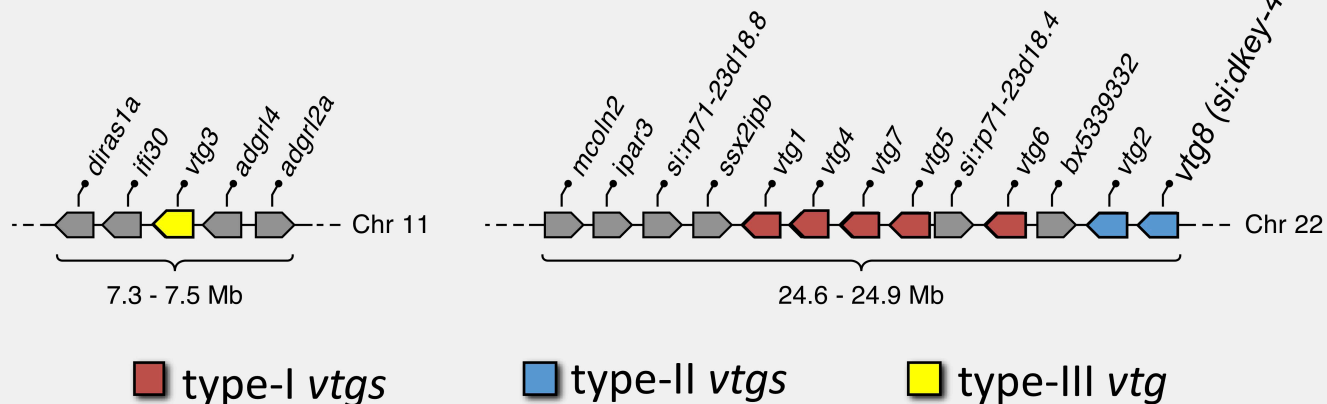
1164 typeface on sequences. Position of primers, target sites and probes on vitellogenin (Vtg) yolk protein (YP) domains
1165 are given on the far right columns.

1166

1167

A) Syntenic organization of zebrafish *vtgs*

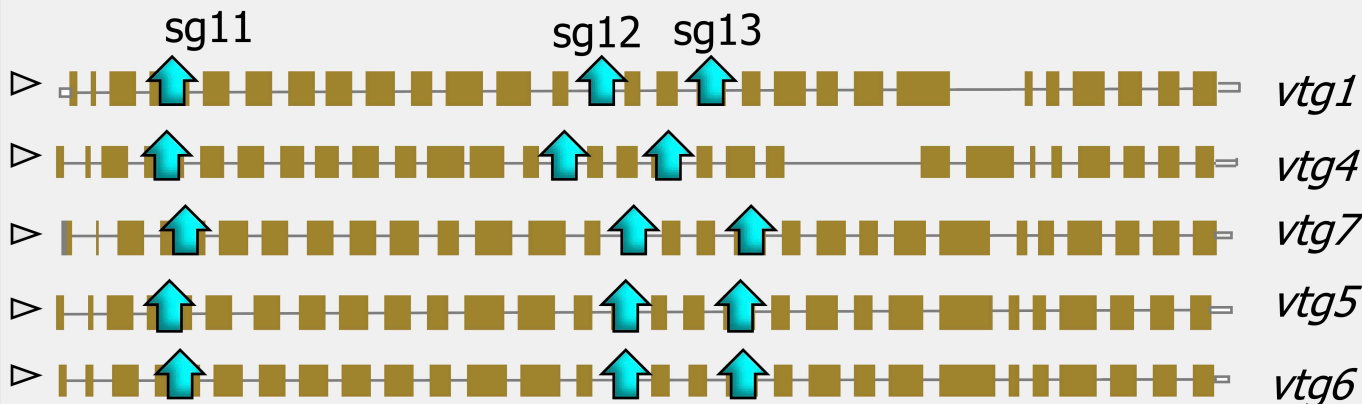
Fig 1



Yilmaz et al., 2018

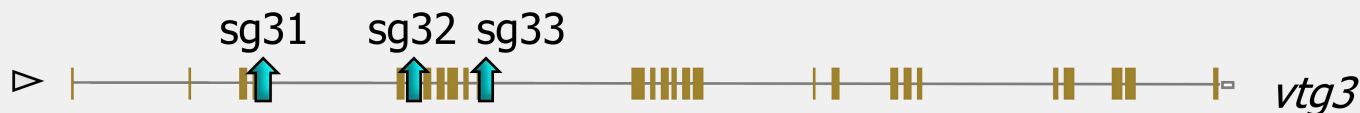
B) *vtg1*-KO

type-I vtgs = 6671-7493 bp *gDNA*



C) *vtg3*-KO

type-III vtg = 20947 bp *gDNA*



A) *vtg1*-KO



Deletion
Frameshift
Stop



Frame 1 5'>3'

MRAVVLALTVACQQFNLVPEFAHDKTYVYKYEALLGGLPQEGLARAGIKVSSKVLISATTENTYLMK**LMD**
 PLLYEYAGTWPKDPFVPATKLTSAALAAQLQIPIKFEYANGVVGVKVFAPAGVSPTVMNLHRGI**LNILQL**NLKKTON
 IYEMQ**EAGA**QGVCRTHYVI**NEDPKANHIIVTKSKDLSHCQERIMKDVGLAYTERCAECTERVKSLIETATYNYIM**
KPADNGALIAEATVEEVYQFSPFNEIHGAAMMEAKQTLAFVEIEKTPVVPKADYMPRGSLQYEFATEILQTPIQ
LMKISDAPAQIVEVLKHLVSNKDMVHDDAPFKFVQLVQLLRVASLEKIEAIWSQFKDKPVYRRWLLDALPAVGT
 PVI**IKFI**KEKFLAGEFTTPEFIQTLVIALQ**MVTAD**PETIKMTASLATHEKFATIPALREVV**MLGY**SGLIAKYCVA
 VPTCPAELLRPIHEIATEAISKNDIPEITLALKV**MGNAG**HPSLKPIMKLLPGLR**TAA**NALPIRVQVD**AI<234aa>**
WLLDPNHVHC-RRL**LKLC**RKELPSS**MLNLC**LQLKCVASCQ**LQ**LVCPWSSVGTLL**QLLQ**VS**MFR**PPLHLLSLR
 NWSP-L**MSN**-RRL**MF**SSKLKLDQVLLSRHLL-WEL**TL**PSSKLLLWQEERSVQLHPEKWQEQTF**SRAT**TRWRCL
 LNFLNTLLLQALRL**MPW**SETLKITVLKGLFPWYLNCLCKTPRHL**MLVI**CHLRCHLLLQ-ELLHLTEPSV**ML**SHT
 LKS**RDV**LRCTLT**MLL**SEIPLFST-LDTTQSVLQWQELKVLQ**LK**DWSLKFKL**VLE**LLRGLLSKSTSL**MMIL**QKDR
 LSC-N-GK**SW**TLK**LMH**LFLKAAAVVTVAAAAAAPALAPAQAQAQVQVQVQAQAPLCPALVCLRLPPSLSLSG
 NSTKIGTWHTIAPQRILAVEVLQALNKC**RNR**IDSLE**MI**FHLFLLSSPVLELTRSFWATNWLLTLTNQLQECN-
 -FP**LL**KTTT-RSV**LM**VLC-ASTKLLASFLG**VRS**ANS**MQ**SLLK**LK**LVSWVNSLLHV-KWNGRDCQ-LSP**PM**PKSW
 VNTSLQQLTTQDSGLNEQRTARKRLN-LQ**PCH**LRGP-ISLLGFQ**RS**QCQKGIFIFLSL**FPS**IQTELFPLR**PM**KTF
 SPGSRNISR**RN**

Rbd/Rbm
anti-zflvH1
epitope

B) *vtg3*-KO



Deletion (in frame)



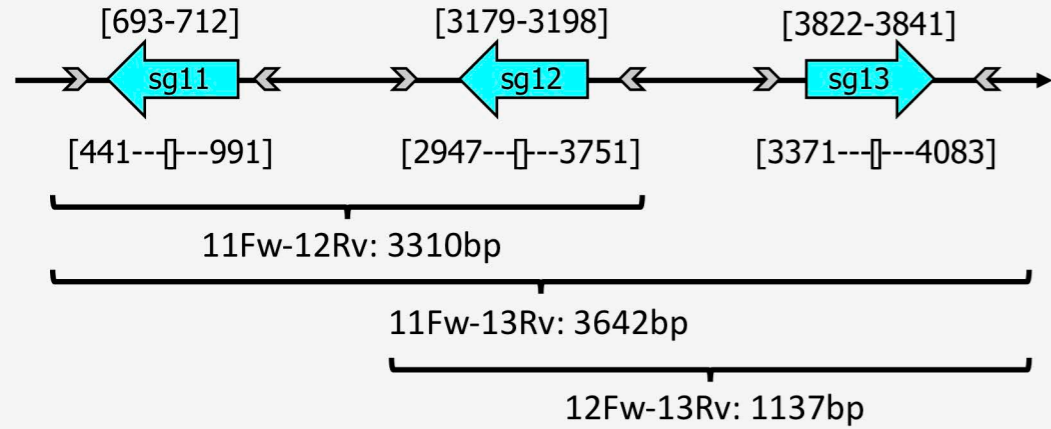
Frame 1 5'>3'

MANYEPFLNSKKTYEYKYEGLVQVGRELPHLVESALKLRCTFKIIGESPHTFVLQVSNVDFEDFNGI**PKSVFS**
 PSKNITKHL**SAE**ISQPIIFEYSKGQITDIRTAPGVSN**TVV**NI**VR**GILGFLQVT**VKT**TQSFYELIELGIHGLCQSS
 YTV**DEDSNAKELIVTRIVDITNCQOPASLYRGMALAPEDKLSKQRGESVVSTVKHTYTVKSTADGGQITKFAQE**
RQYFSPFN**VKGGNF<238aa>**LK**TLL**KFLPGYSNGAEKLSTRVQGA**AVQAF**RLLASRASHSVQD**IVL**NLFVQKHL
 PAEIR**ML**LACIVLLET**KP**STALISVVSEVLL**EAD**LQVASFYSLLKGF**AKS**RTPD**NQH**LSIAC**NIAM**KILTRKLG
 HLSYRYSKNLHFDWFHDDFLFGTSADV**MLQ**NESPIPT**KLML**KGKFHF**IGR**ILQFLEFGIRADGLKDLFAGKIPE
 LTKDLGISDLASILKILSNWQSLPKDKPLL**TAY**RVFGQEAFL**MD**VS**RS**DSVQSI**IKS**FSPSAGKESKVWERIQDV
 QK**GT**SWHWTKPHLVYEARFIQPTCLGLPVEISKYYSV**VNA**VT**MKAKAE**INPPPKEHLGELLSSDIS**MQ**TDGFIGV
 TKD**H**FLFHGINTDLFQCGTELKSKV**SM**GLPWAFDLKIN**PKE**QTYE**MNL**TPSKSVTELF**SVSS**NVYAVLRNIEDPT
 SSKIT**PM**PETGESWQGVPLR**ML**PPLRDEQTKKSG**MK**FRQCA**EAKI**YGTALCIEAEAKRAHYLHEYP**LY**LLGDT
 HFSYSLEPAK**DAK**PIEKIQIQVSASRQ**HPS**V**MSG**MVN**LN**QRVFKETR**DENTS**CEERKTSSSLPV|TQDLLDVTPDP
 VVT**VK**ALSLS**PQ**AKPLGYEGVAFY**LPTAQKDDIEMIVSEVGE**EAN**NW**K**MC**ANA**HF**DKTHTSAKAHLRWGAECQTYD
 V**SM**RVSAACQ**PES**KPSISTKINWGTLP**S**VFTTVGQIVQ**EY**VP**GS**Y**IMG**FYQKKEENPERQASVIVVASSPETFD
 LK**VK**IPERTIYKKKIP**SPI**ELLGIEAN**LT**MST-

Rbd/Rbm

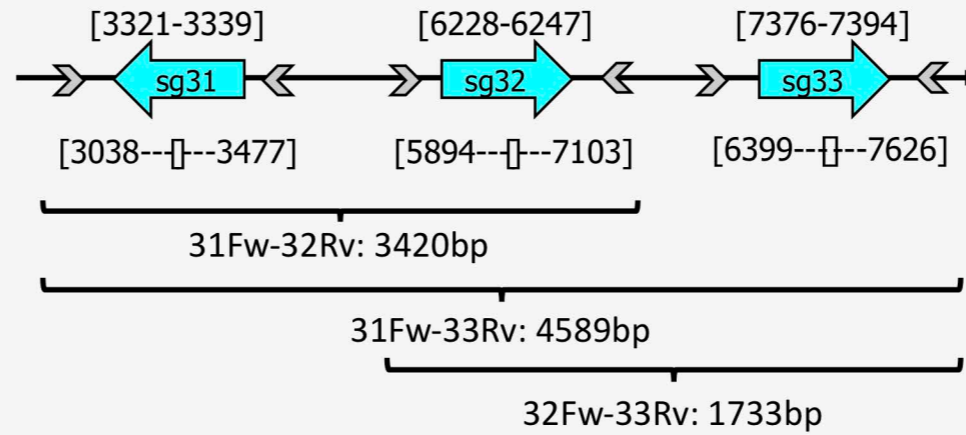
anti-zflvL3
epitope

vtg1-KO Embryo Genotyping



wild type : 3642 bp
mutated: 2361 bp

vtg3-KO Embryo Genotyping



wild type : 1733 bp
mutated: 551 bp

Pure Line Production

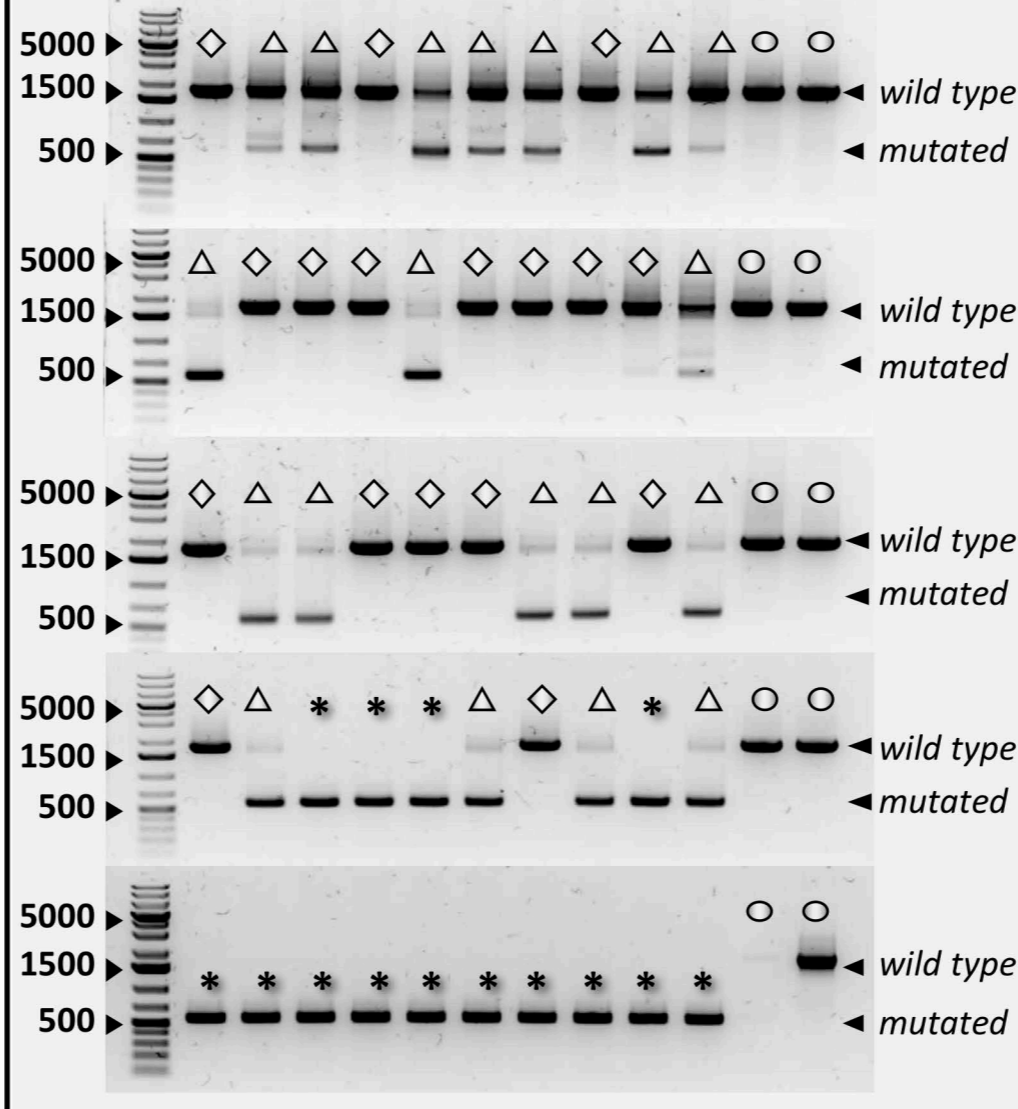
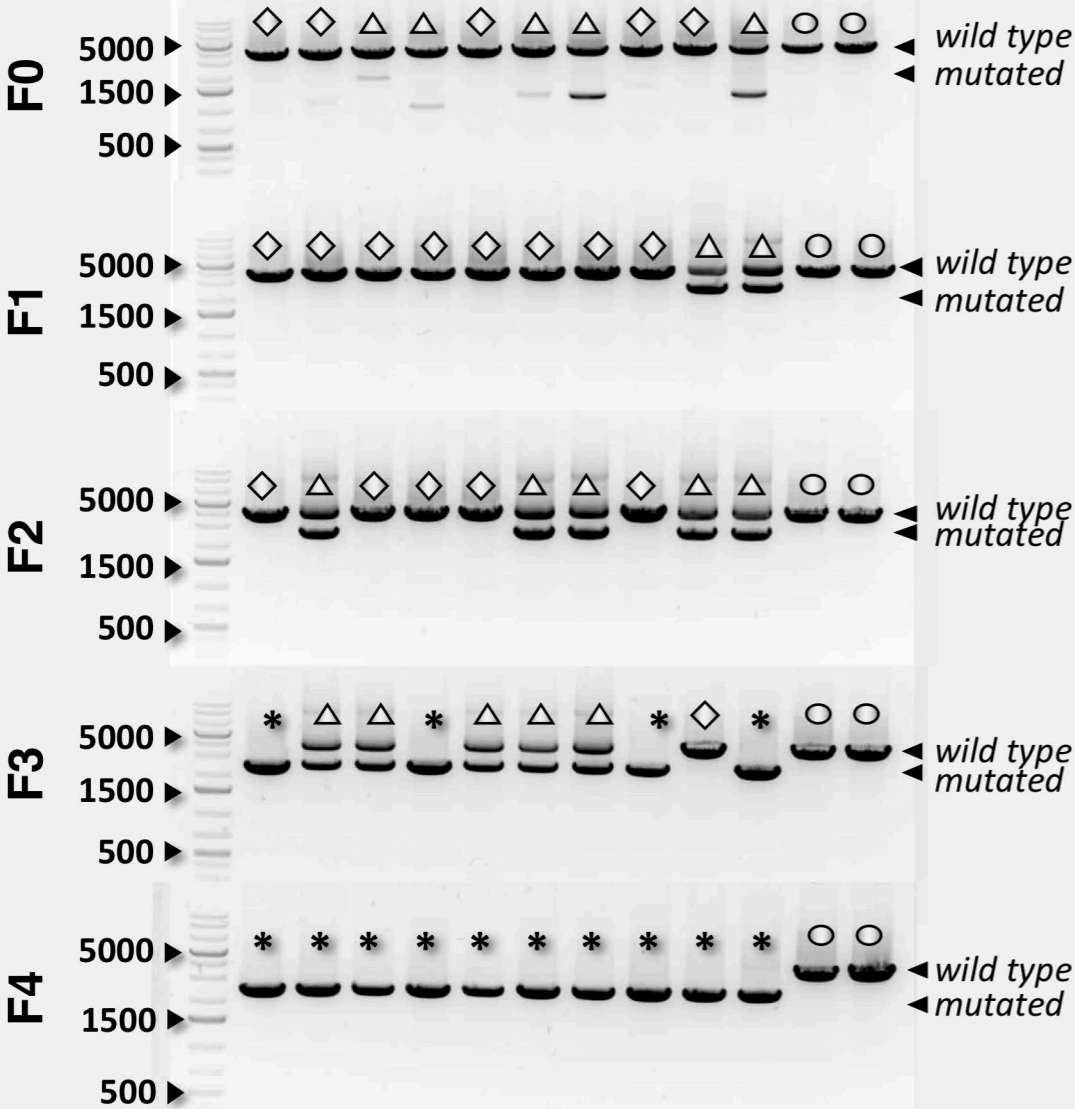
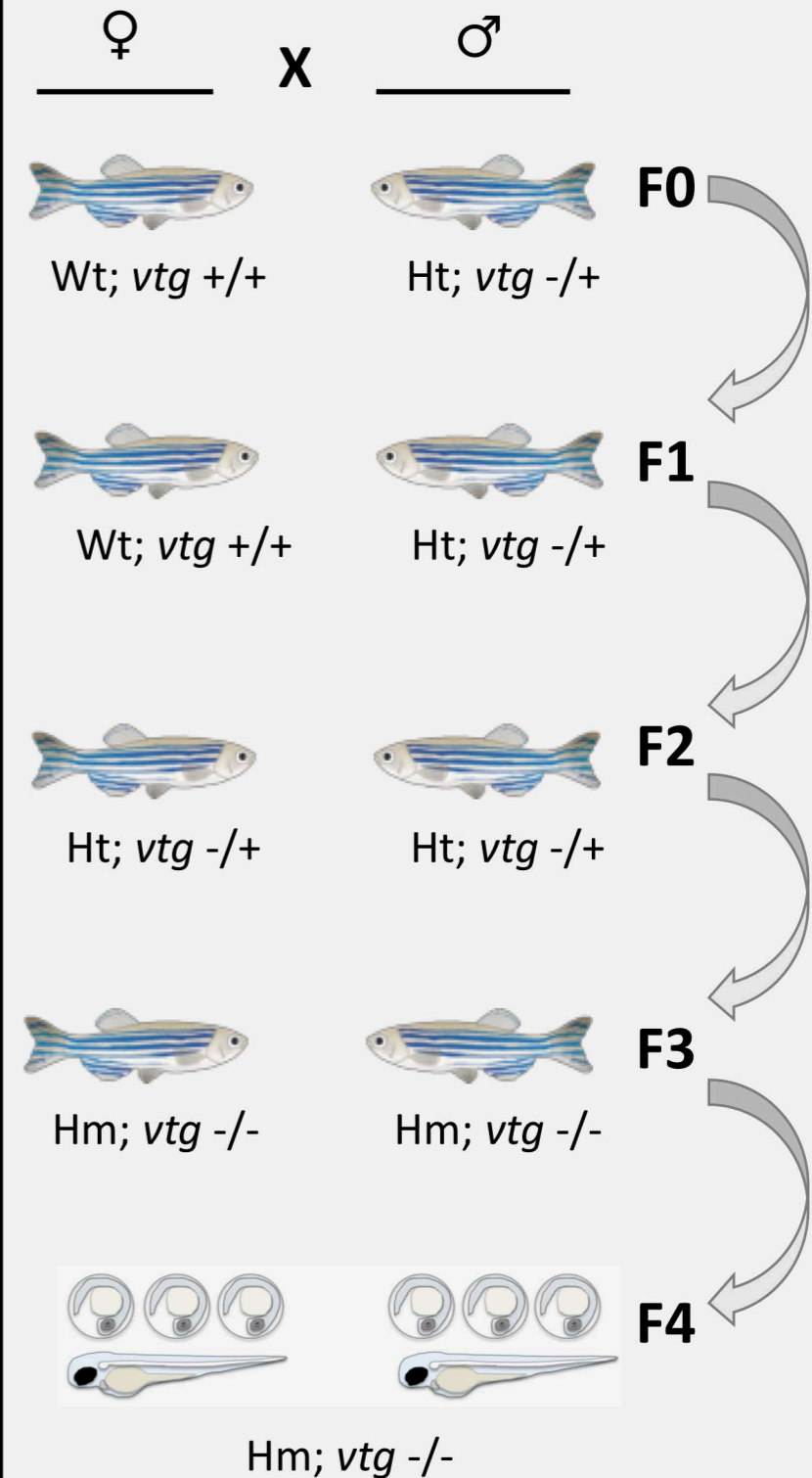
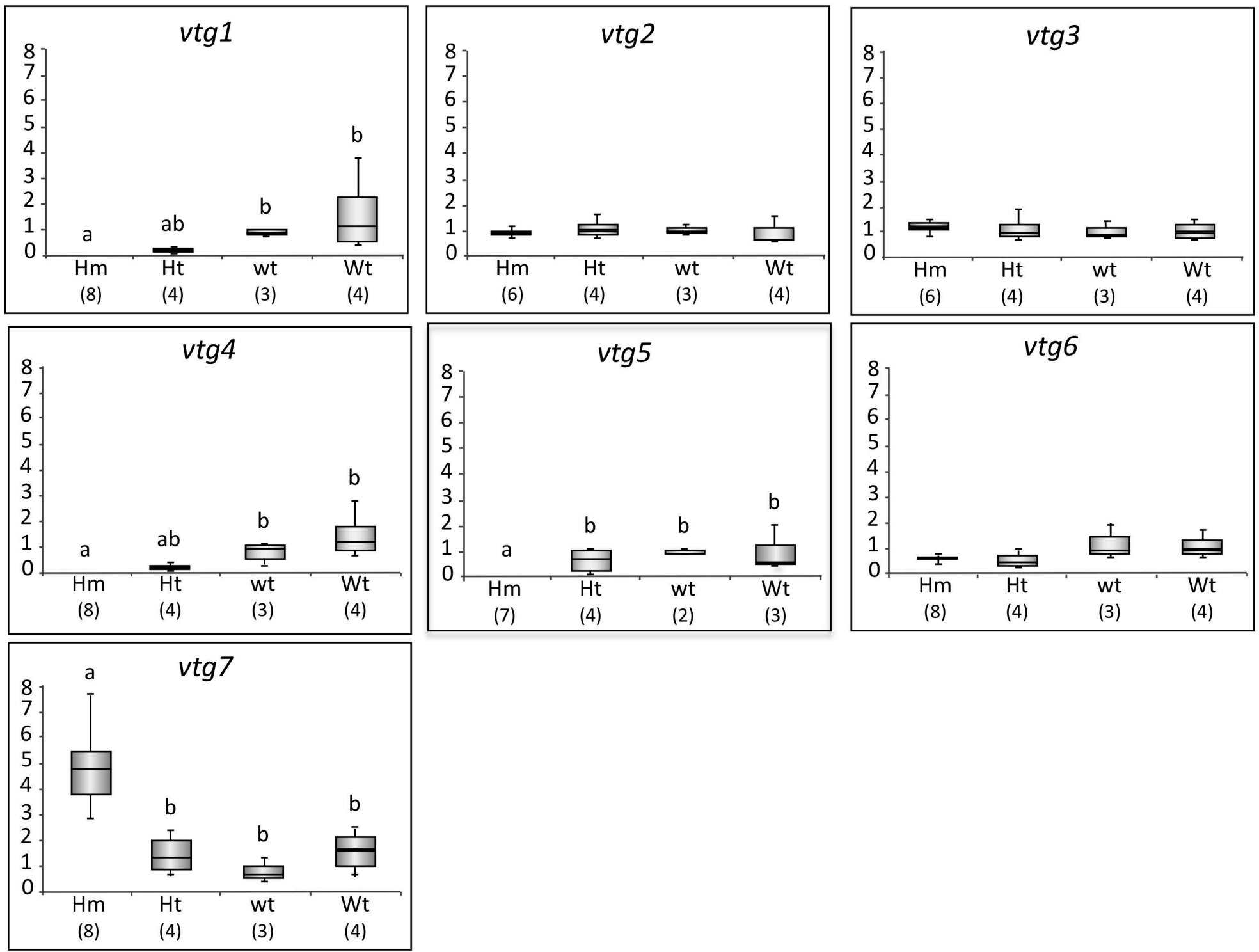
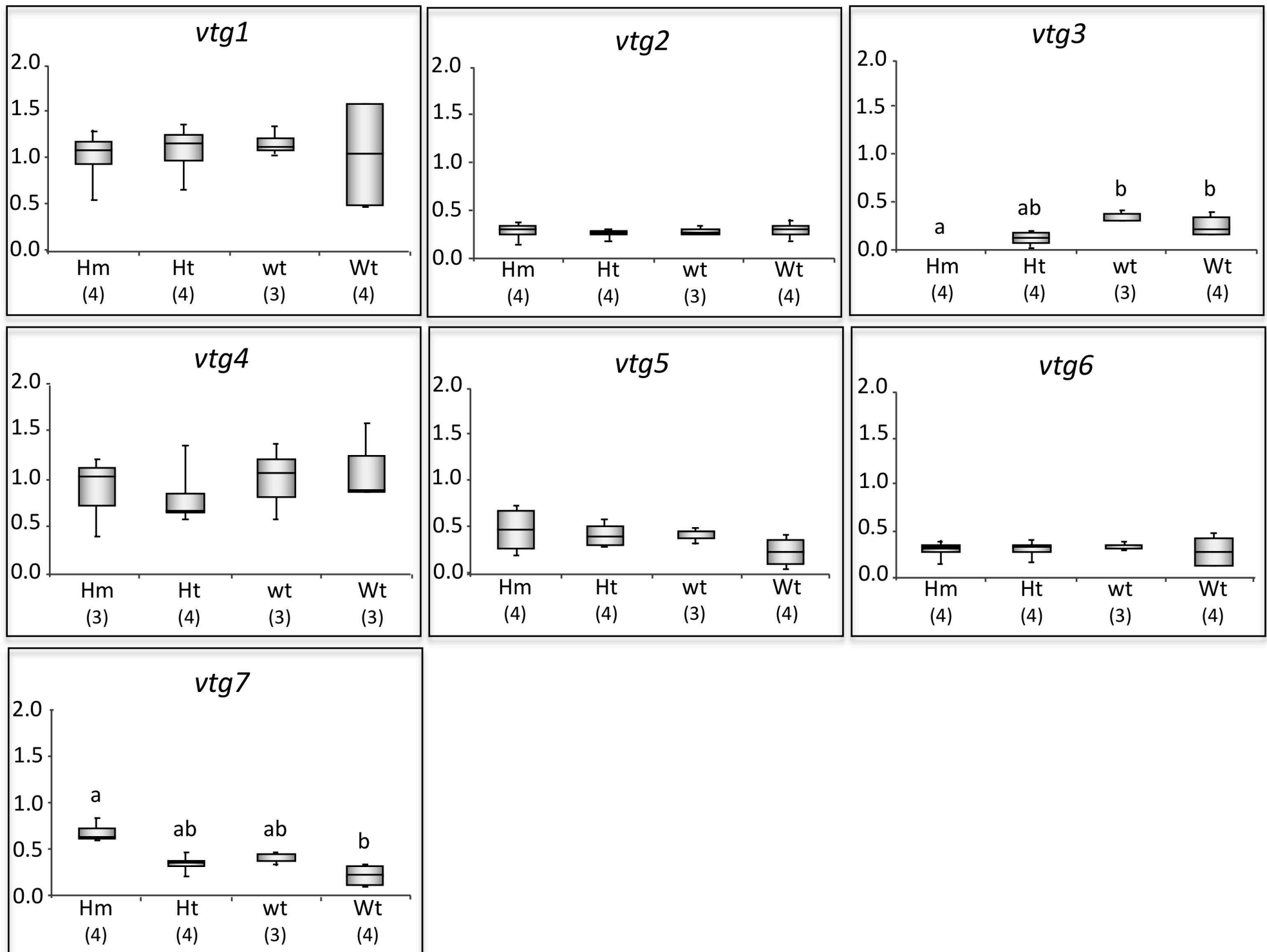


Fig 3

A) vtg expression in vtg1-KO liver



B) vtg expression in vtg3-KO liver



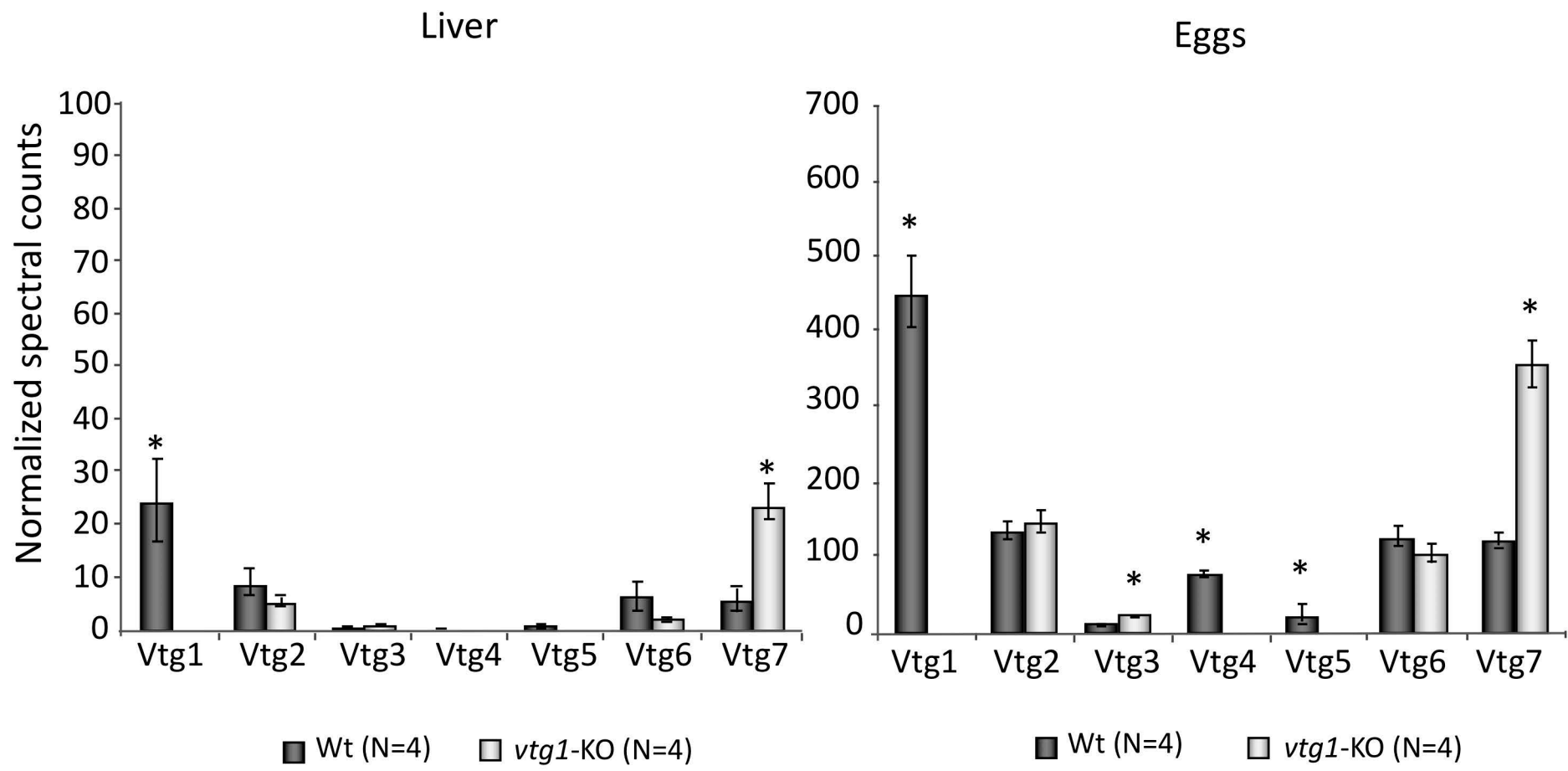
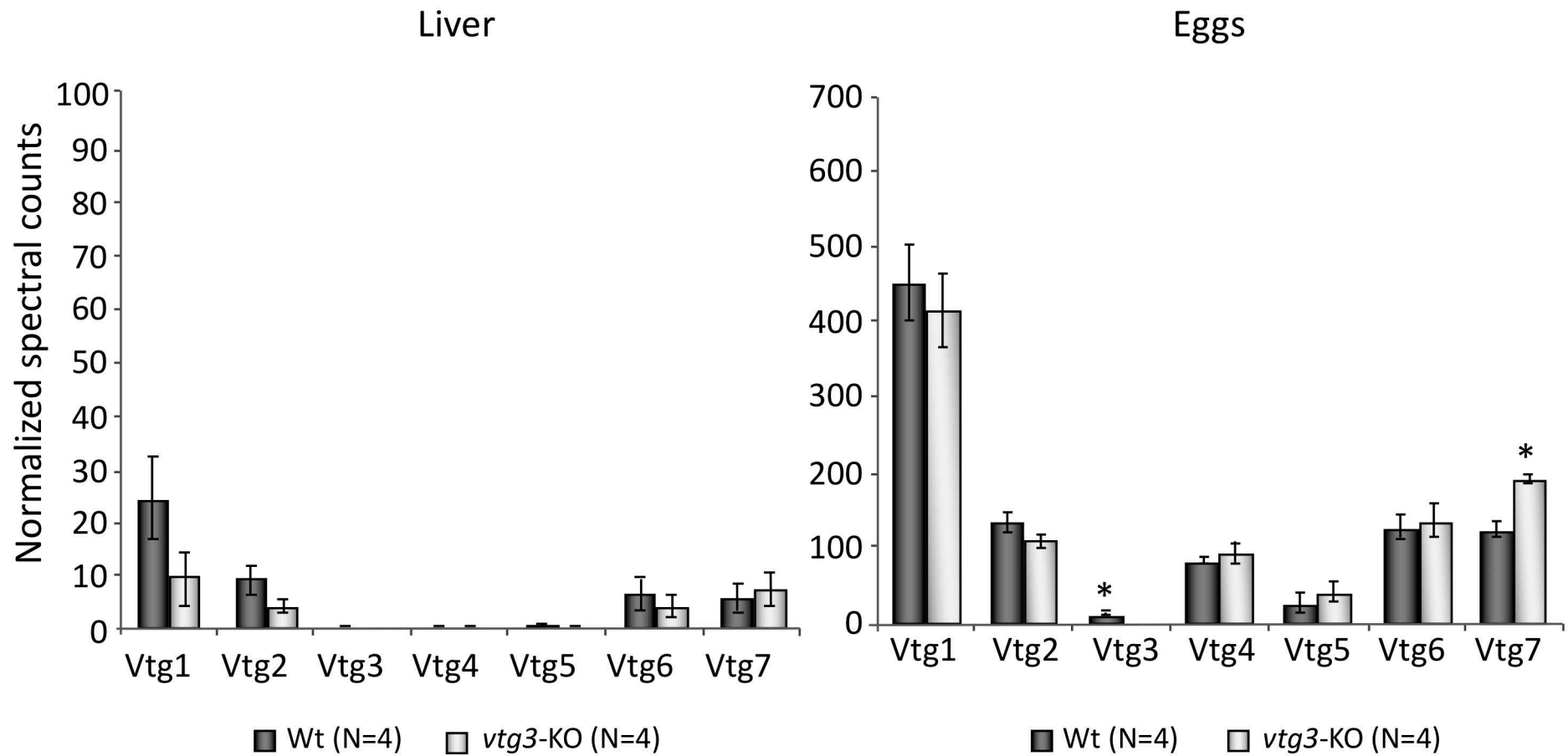
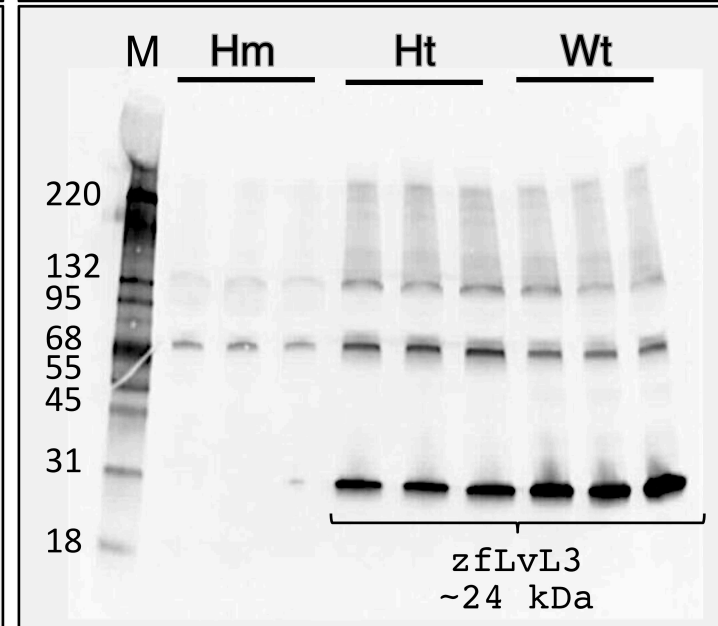
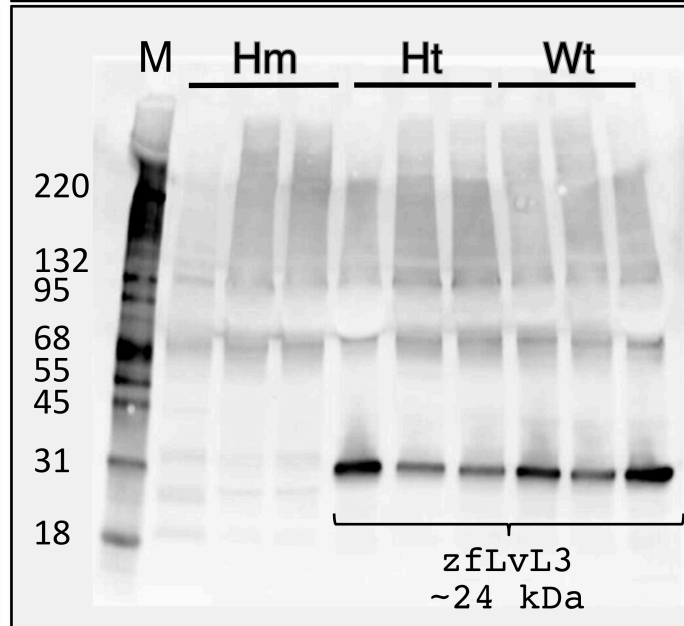
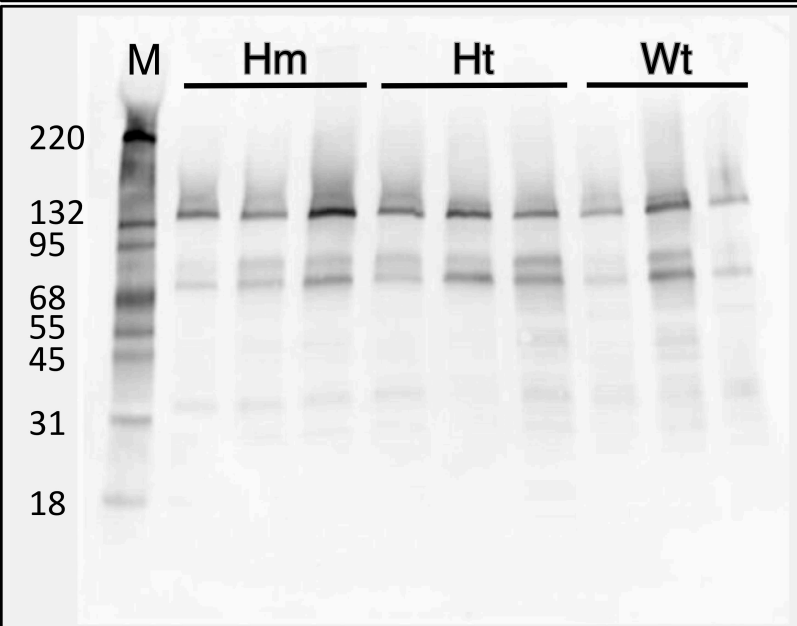
A) *vtg1*-KOB) *vtg3*-KO

Fig 6

vtg3*-KO Liver**vtg3*-KO Ovary*****vtg3*-KO Eggs**

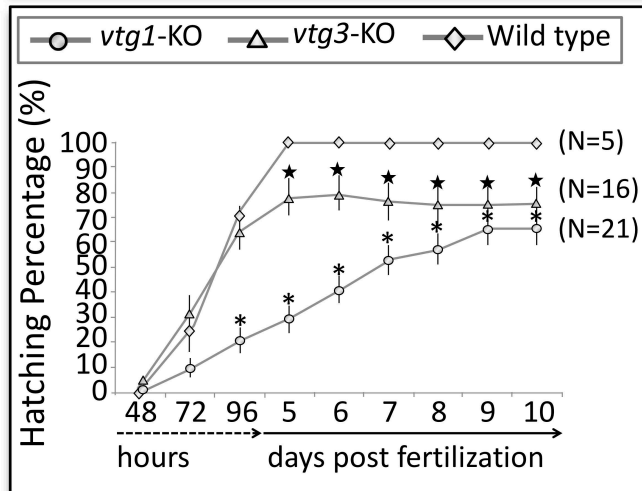
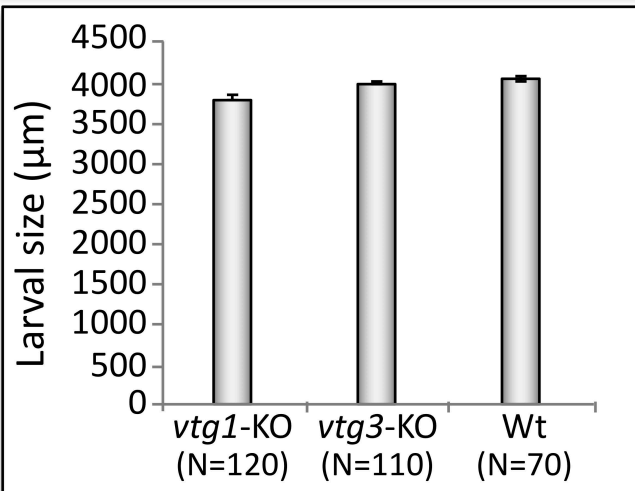
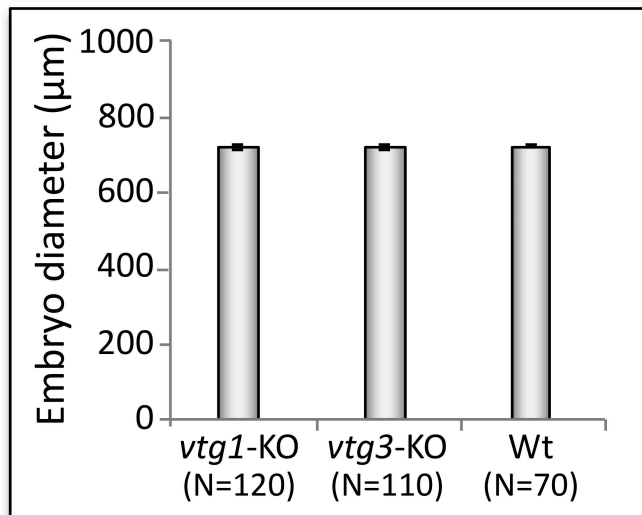
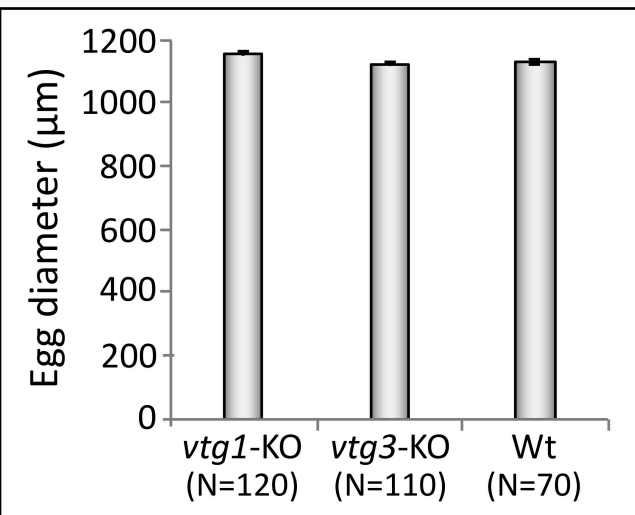
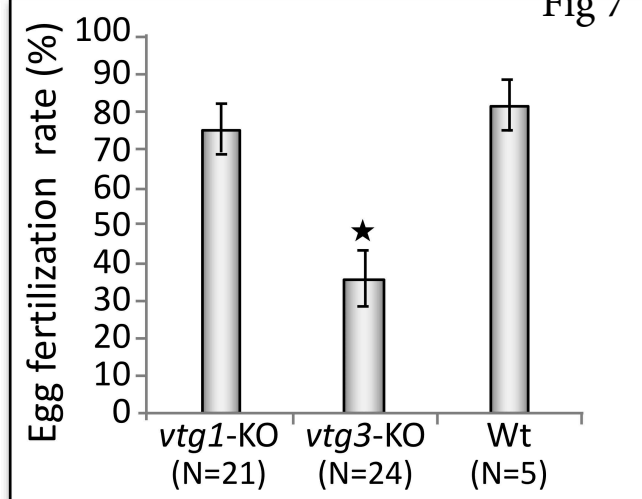
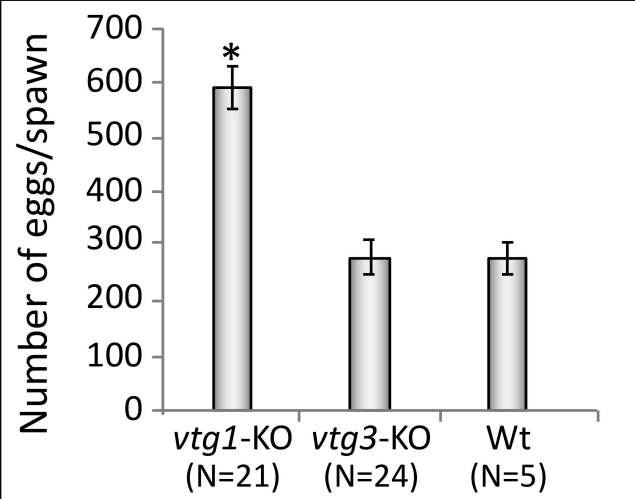
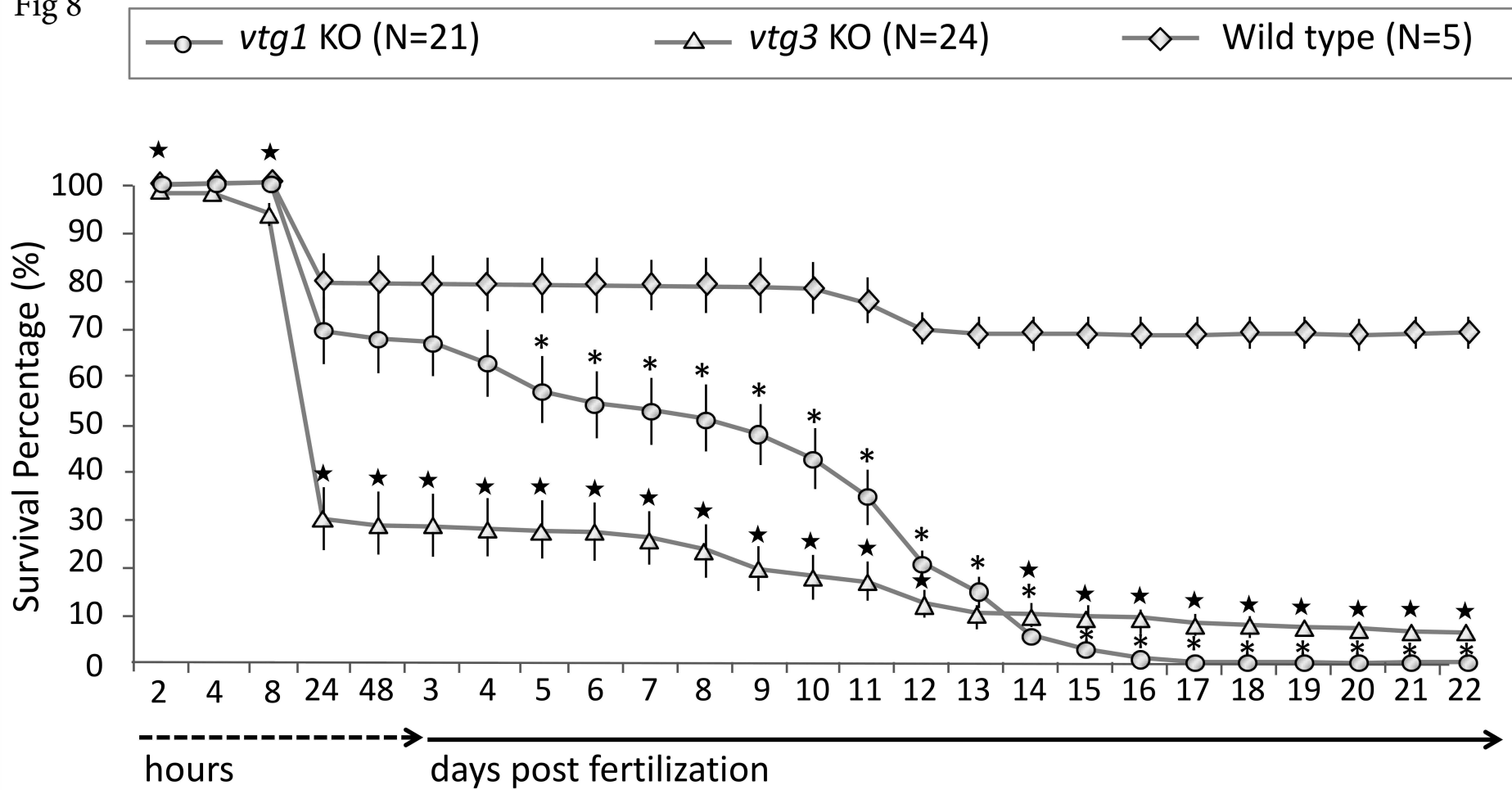


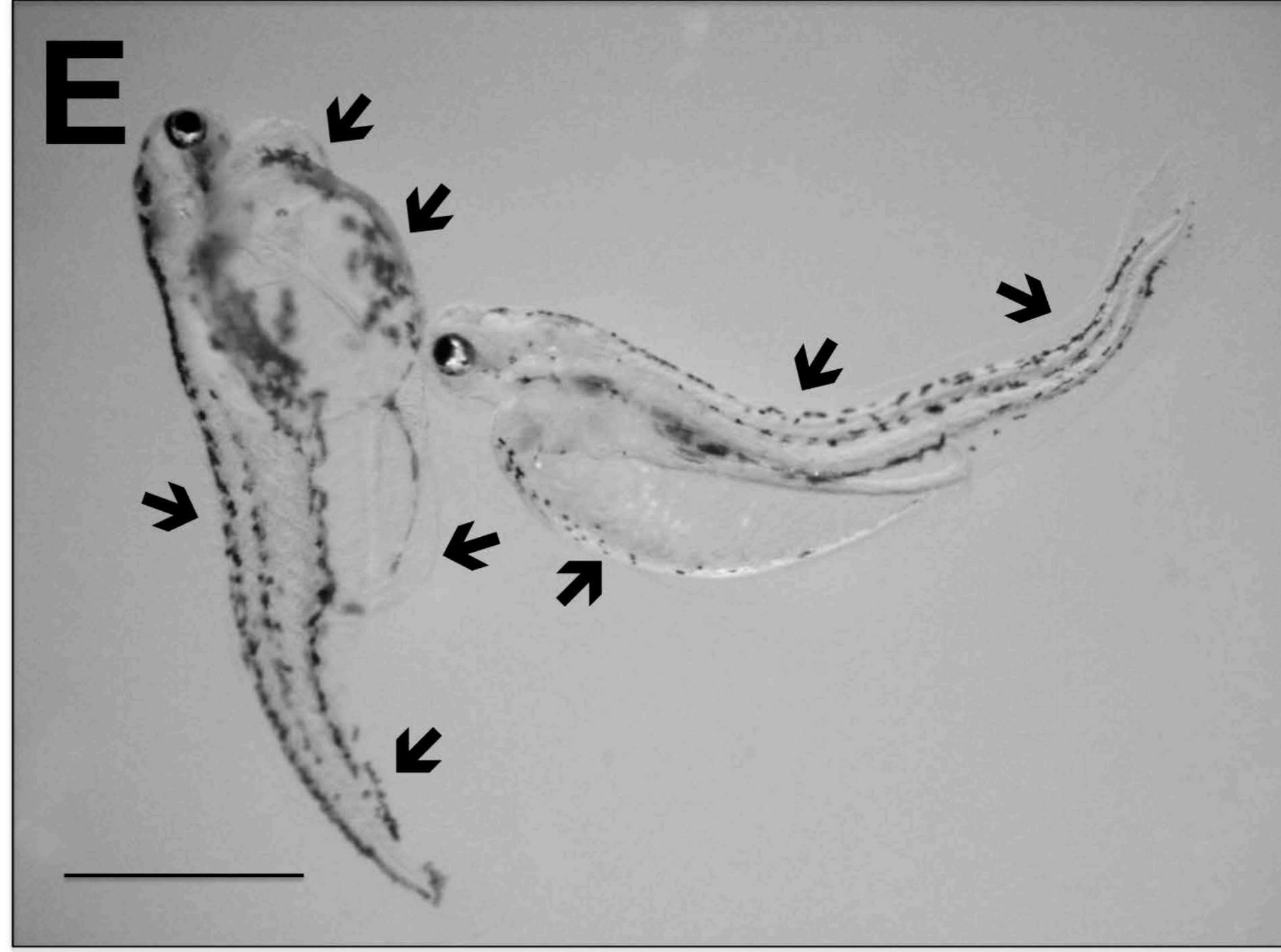
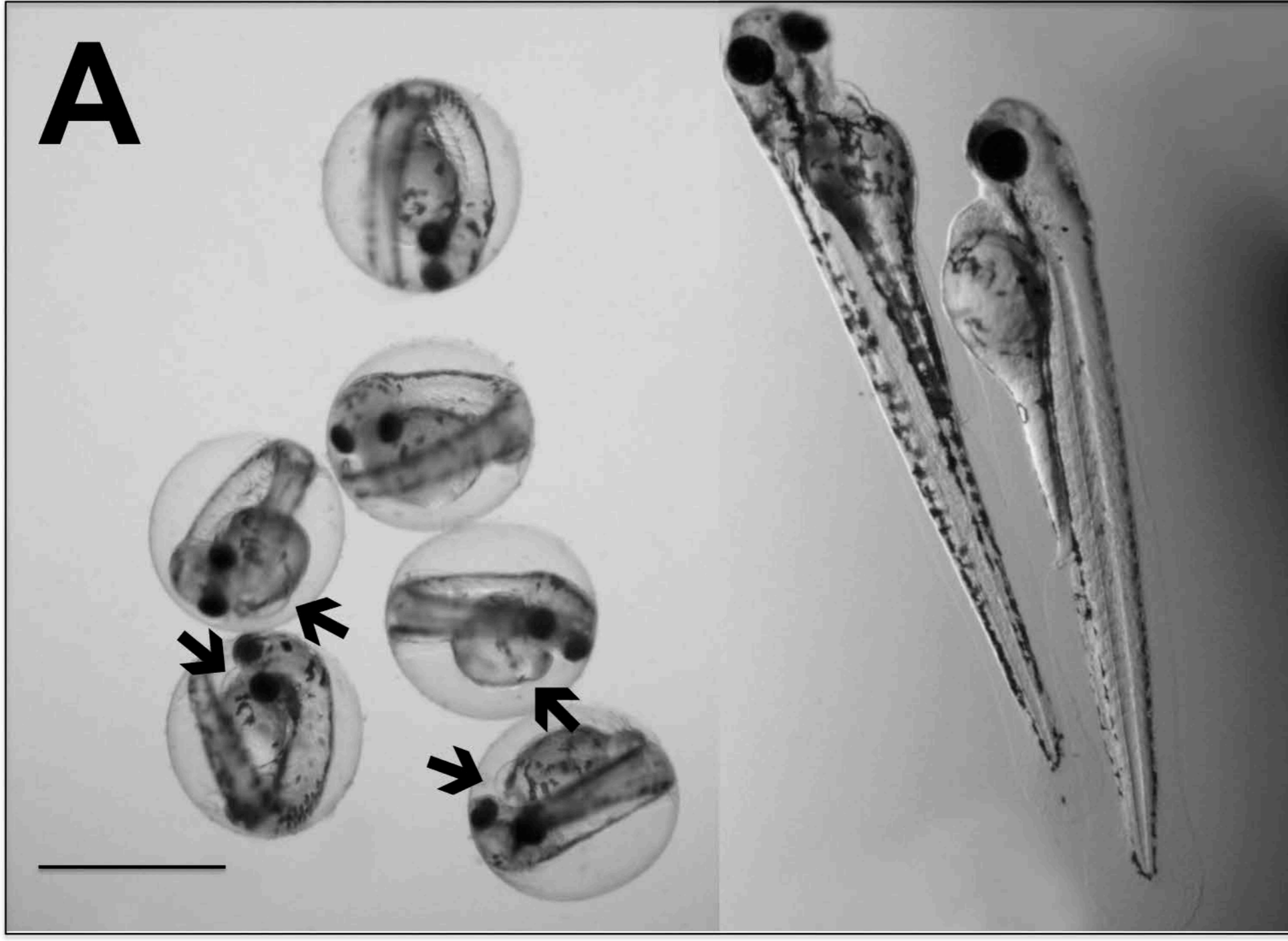
Fig 8



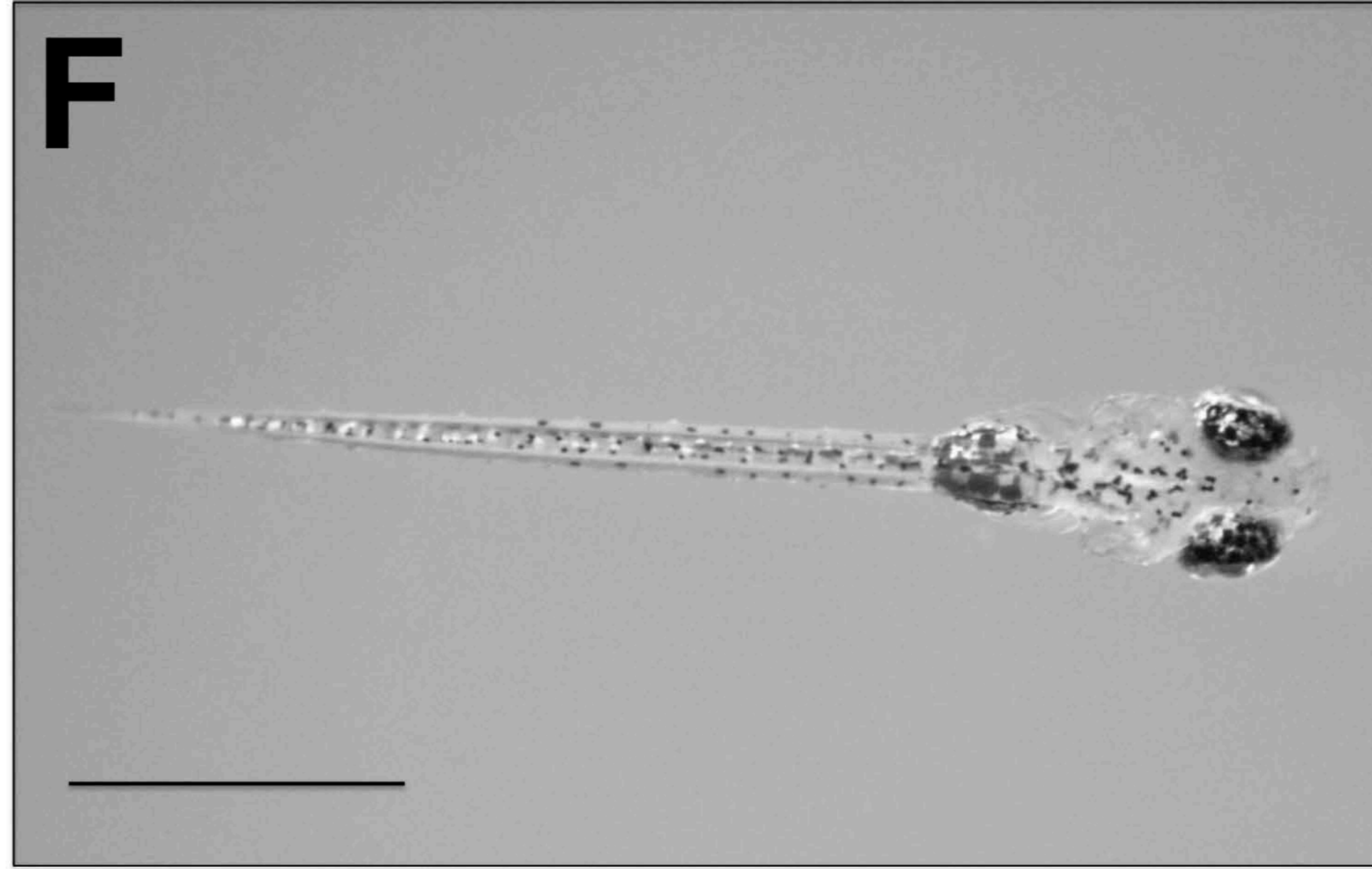
4 dpf

8 dpf

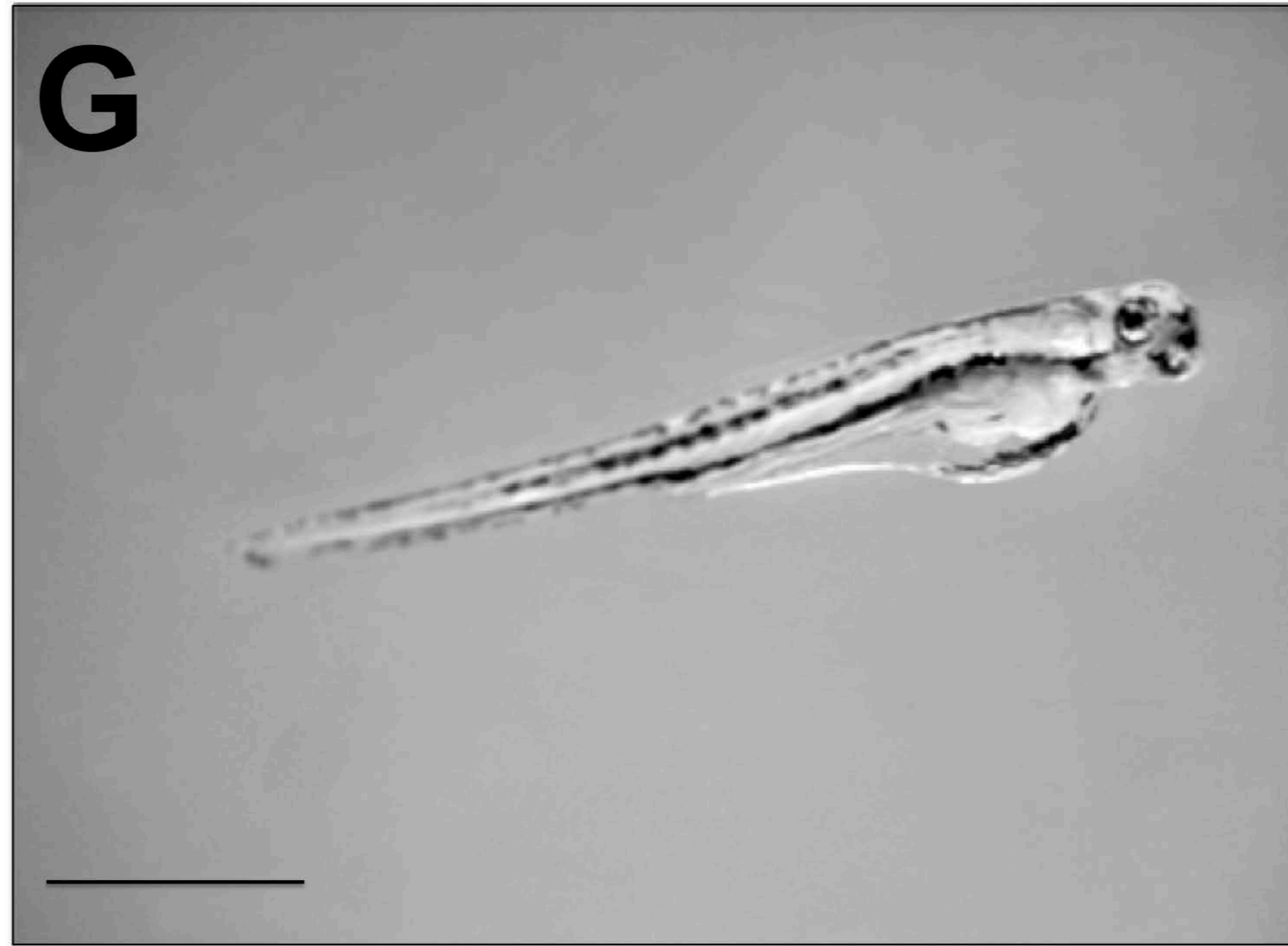
vtg1-KO



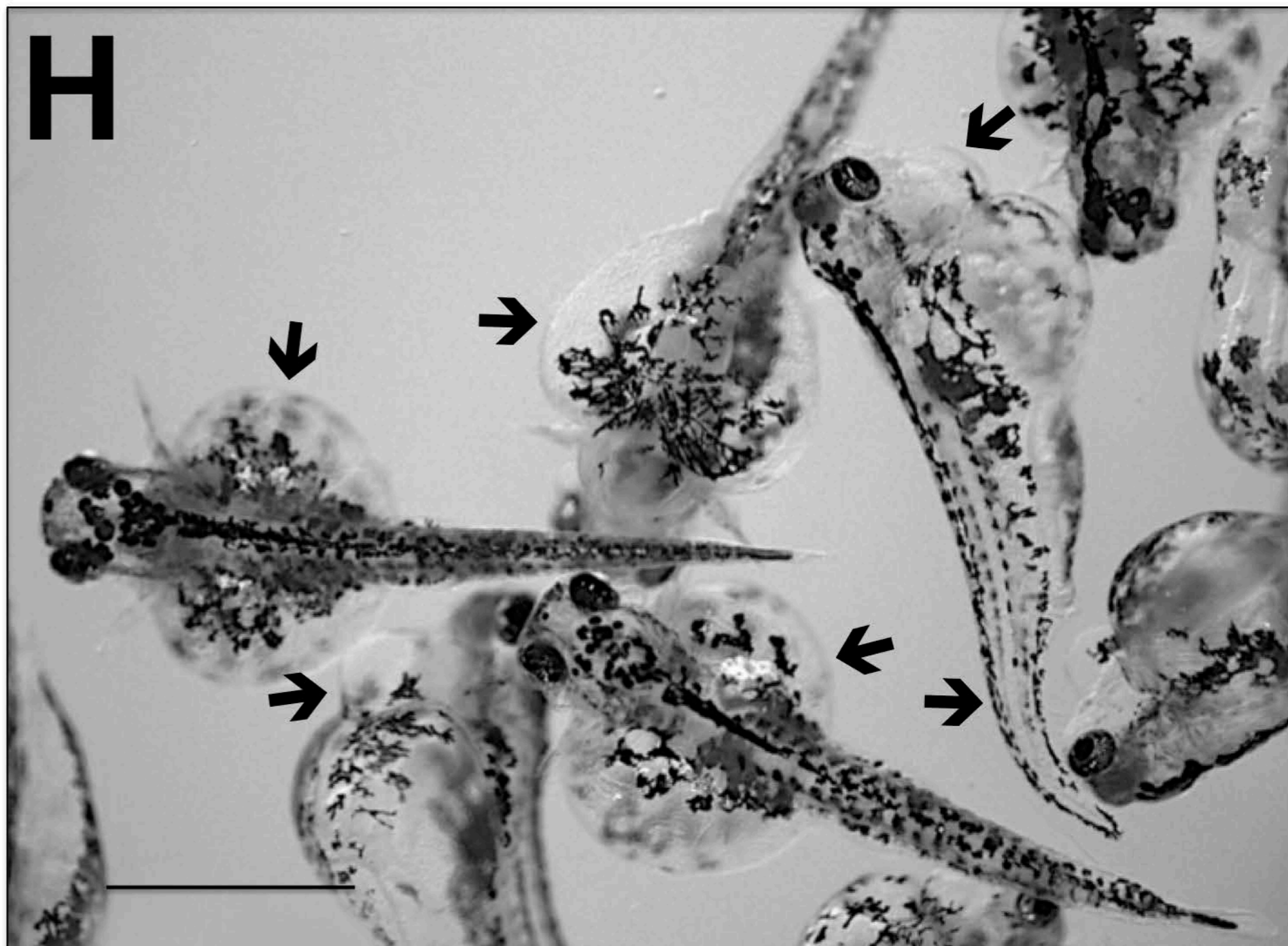
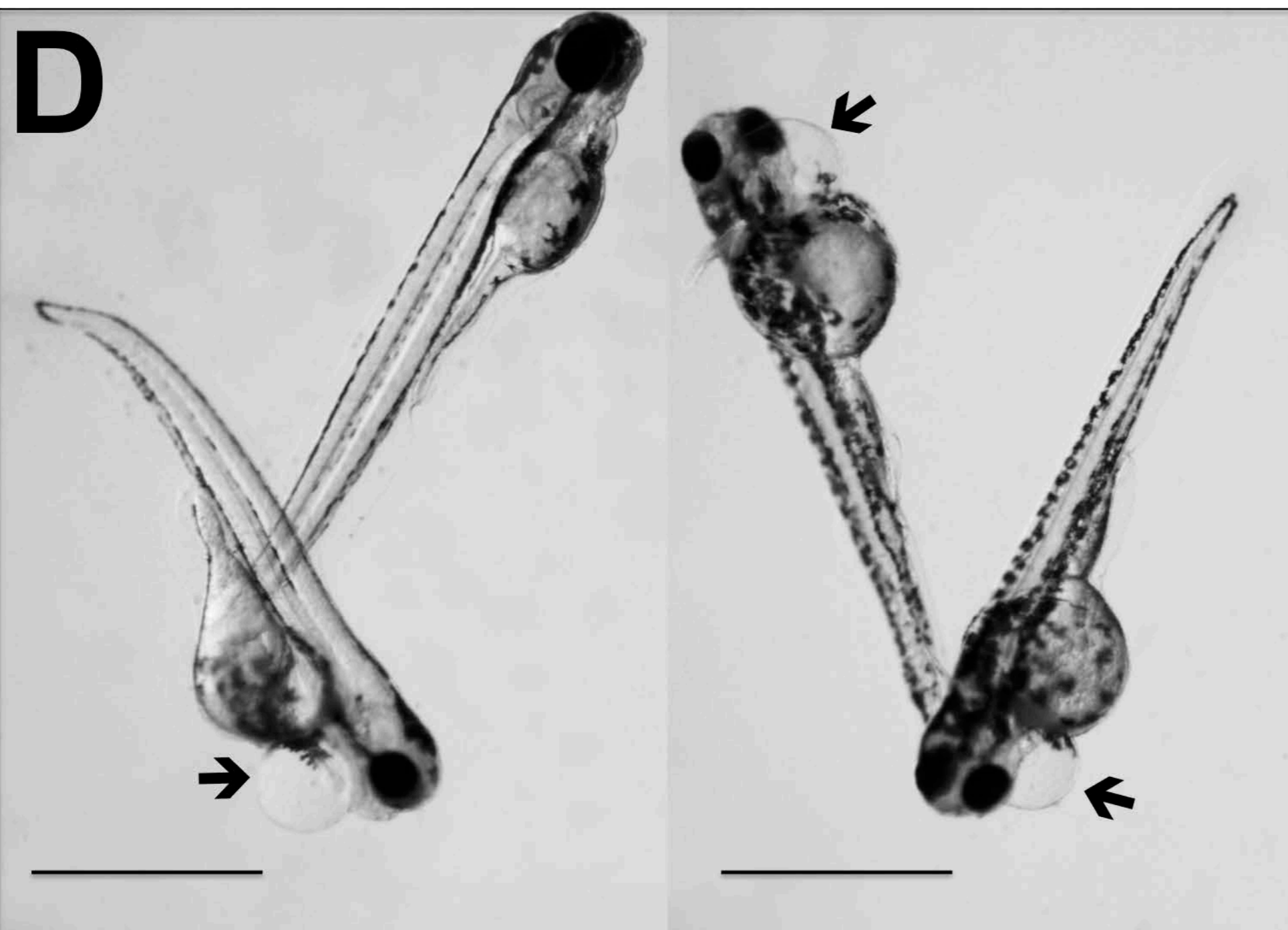
Wild type

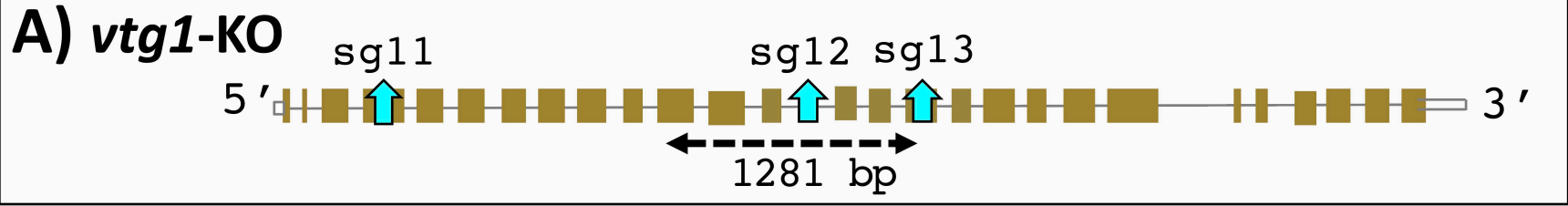


Wild type



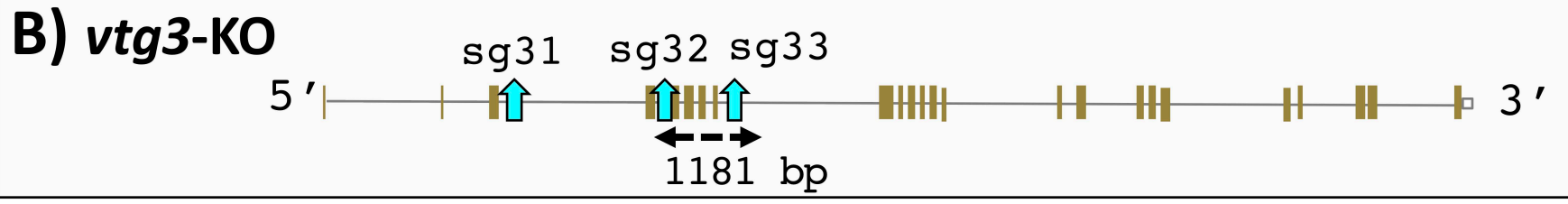
vtg3-KO





<i>vtg1</i> ^{-/-}	CTTCCTGGACTGAGAAGCTGCAGCTAATGCTTTGCCATTAGAGTCCAGGTTGATGCCAT-	2458	
<i>vtg1</i> ^{+/+}	CTTCCTGGACTGAGAAGCTGCAGCTAATGCTTTGCCATTAGAGTCCAGGTTGATGCCATC	2460	Exon 11

<i>vtg1</i> ^{-/-}	-----	2458	
<i>vtg1</i> ^{+/+}	TTGGCCCTGAGAAACATTGCTAAGAAAGAGCCAAACTGGTAAGATTCAGGTATTTTAGA	2520	
<i>vtg1</i> ^{-/-}	-----	2458	Intron
<i>vtg1</i> ^{+/+}	TATGAACTGCTGTAATGTTATGCATGTTTTCTTCCAATGAAAAAACTTTGTTTCTCTGT	2580	
<i>vtg1</i> ^{-/-}	-----	2458	
<i>vtg1</i> ^{+/+}	ATCAGGTTTCAGCCTGTTGCCCTGCAGCTTGTTTTGGACAGAGCTCTCCACCCCGAGGTGC	2640	
<i>vtg1</i> ^{-/-}	-----	2458	
<i>vtg1</i> ^{+/+}	GCATGGTTGCTTGTATTGTGCTGTTTGGAGCTGAGCCTTCAGTGGCACTTGTCTCTAGTC	2700	Exon 12
<i>vtg1</i> ^{-/-}	-----	2458	
<i>vtg1</i> ^{+/+}	TTGCTGGAGCTCTAAGGATTGAGCCAAACATGCATGTTGCAAGCTTGCCTATTCCACA	2760	
<i>vtg1</i> ^{-/-}	-----	2458	
<i>vtg1</i> ^{+/+}	TCAAGTCCTTGACCAGAATCACTGCTCCTGATATGCATCTGTGTAAGAAAAGCCAATAT	2820	Intron
<i>vtg1</i> ^{-/-}	-----	2458	
<i>vtg1</i> ^{+/+}	ATTTTCAGTTTTGTGTTTTTACATTAATTTCTCCATGTTTTTTCACACTTACACATGAAAC	2880	
<i>vtg1</i> ^{-/-}	-----	2458	
<i>vtg1</i> ^{+/+}	GAGTACAAGCCTAGGTAATCATGGCTATTTATTTTCAGTGTCTGGTGCAGCTAATGTTGCA	2940	Exon 13
<i>vtg1</i> ^{-/-}	-----	2458	
<i>vtg1</i> ^{+/+}	ATCAAGCTTATGAGCCGCAAACCTGGACAGACTTAACTACCGTTACAGCAGAGCTTTTCAG	3000	
<i>vtg1</i> ^{-/-}	-----	2458	
<i>vtg1</i> ^{+/+}	ATGGACTATTATTATAGTAAGAATTTCTAATTTCTTAAGAGCTAAGAAATTATATCGGAT	3060	Intron
<i>vtg1</i> ^{-/-}	-----	2458	
<i>vtg1</i> ^{+/+}	GTTTTCTTAAACTGCATTAAAAATTTGTCTGACATACAGTATTGCAAATTTATTCTTTAAAT	3120	
<i>vtg1</i> ^{-/-}	-----	2458	
<i>vtg1</i> ^{+/+}	GTATCTTTTAAATTTGTCCATTAAGCTCCTCTTATGATTGGAGCTGCTGGTAGTGCCTAT	3180	Exon 14 (sg12)
<i>vtg1</i> ^{-/-}	-----	2458	
<i>vtg1</i> ^{+/+}	ATGATCAATGATGCTGCCACCATCCTGCCAGAGCTGTTGTAGCTAAAGCTCGTGCTTAC	3240	
<i>vtg1</i> ^{-/-}	-----	2458	
<i>vtg1</i> ^{+/+}	CTGGCTGGAGCTGCTGCTGATGTTATTGAGGTTGAACCATCTAAAATTTCTTACTAGATA	3300	Intron
<i>vtg1</i> ^{-/-}	-----	2458	
<i>vtg1</i> ^{+/+}	TTTGGCTACTATTTAAATCAATTTTAAAATGCATCACTAAATGTTCTCTAAAACAGT	3360	
<i>vtg1</i> ^{-/-}	-----	2458	
<i>vtg1</i> ^{+/+}	TTGGTGTGAGAACTGGAGGAATCCATGAAGCTCTCCTAAAATCTCCTGCTGCAGATGAAA	3420	Exon 15
<i>vtg1</i> ^{-/-}	-----	2458	
<i>vtg1</i> ^{+/+}	GTGCTGACCGTATCACAAAGATTAAGCGTACACTGAGAGCAGTAAGTTTTTTTATGTCC	3480	Intron
<i>vtg1</i> ^{-/-}	-----	2458	
<i>vtg1</i> ^{+/+}	ATAGTATCTTAATTTTACACTTTAATTATAAAAATGAAAAAGAAAAACTGACTTAAAAA	3540	
<i>vtg1</i> ^{-/-}	-----	2458	
<i>vtg1</i> ^{+/+}	TGATTTGTTTCTTCAAGCTCACAAACTGGAAGGCTTTGCCAACCGATAAACCACTAGCAT	3600	Exon 16
<i>vtg1</i> ^{-/-}	-----	2458	
<i>vtg1</i> ^{+/+}	CAGCCTATCTCAAAGTATTTGGACAAGAAGTGGCTTATGTCAACTTTGACAAGACCATCA	3660	
<i>vtg1</i> ^{-/-}	-----	2458	
<i>vtg1</i> ^{+/+}	TTGAAGAAGCCATACCGTATTGTGTTGTCATTTATCTCTTCCCTACCATATGCTTGAAGT	3720	Intron
<i>vtg1</i> ^{-/-}	-----	2458	
<i>vtg1</i> ^{+/+}	CTAAGAACTTGAAGTGTGACTGATACTCACAAATGGAATTAAGCTTCTAATAAACACTTT	3780	
<i>vtg1</i> ^{-/-}	-----	2458	
<i>vtg1</i> ^{+/+}	CTTCAGATGGCTACTGGACCCAAACCACGTGCACTGCTGAAAGGAGCTCTTAAAGCTTTG	2559	Exon 17 (sg13)
<i>vtg1</i> ^{-/-}	-----	2458	
<i>vtg1</i> ^{+/+}	CTTCAGATGGCTACTGGACCCAAACCACGTGCACTGCTGAAAGGAGCTCTTAAAGCTTTG	3840	



<i>vtg3</i> ^{-/-}	AAAGCATTTGCTCAGGAGCGCCAATATTTCTCTCCGTTCAATGTAAA	337	
<i>vtg3</i> ^{+/+}	AAAGCATTTGCTCAGGAGCGCCAATATTTCTCTCCGTTCAATGTAAA	6240	Exon 6 (sg32)

<i>vtg3</i> ^{-/-}	-----	339	
<i>vtg3</i> ^{+/+}	CGAATGTTGGCATTGTAAGTGTCTTAAGTCTTCAACTTTCAAGTGGTTGCACTCCTG	6300	Intron
<i>vtg3</i> ^{-/-}	-----	339	
<i>vtg3</i> ^{+/+}	ATTAATCAATGATGTTGTGCTTCCCTTTTACCAGGCGGGACATTGAACTTCTTAAAGTTTC	6360	
<i>vtg3</i> ^{-/-}	-----	339	
<i>vtg3</i> ^{+/+}	AGACACAACCTGACAAAGTAGTACTGGACAGGTGCAGAGCAGAGGCAACCTGATGTATAA	6420	Exon 7
<i>vtg3</i> ^{-/-}	-----	339	
<i>vtg3</i> ^{+/+}	GACAAATAAGGACCTCAAACCAATACCTGTTGTGATGCTTAACCTGAACGACCCAGTGCC	6480	
<i>vtg3</i> ^{-/-}	-----	339	
<i>vtg3</i> ^{+/+}	CAAGGCAAACTTCAAAGATTATATAAACATTTAAGCATATACAGACATGAGAATTAACTC	6540	Intron
<i>vtg3</i> ^{-/-}	-----	339	
<i>vtg3</i> ^{+/+}	ATTAATCGTTTAAATCATACTTTACTCCAACAGATTTTAGATTTAATCAAGCGCCTCGCA	6600	Exon 8
<i>vtg3</i> ^{-/-}	-----	339	
<i>vtg3</i> ^{+/+}	CAGGCTAATATATATCATGTGGACAGTGAACCAGCACAGAAATCTGGACCTAATTCAG	6660	
<i>vtg3</i> ^{-/-}	-----	339	
<i>vtg3</i> ^{+/+}	TTGATGCGGGTAACAACACTTGATAATCTAGAGCATTATGGAAGCAGGCTCAGGAAAT	6720	
<i>vtg3</i> ^{-/-}	-----	339	
<i>vtg3</i> ^{+/+}	GATGAGCACAGGATATGTTCCACCTTCTCTAAATACTATAACAATCTAATATCAAGATGAT	6780	Intron
<i>vtg3</i> ^{-/-}	-----	339	
<i>vtg3</i> ^{+/+}	CAATTTCCCTGTTGACTTTCTTTTTTTTTTGGTCAAGCGGTGGTTCTTGGACTTGGTTG	6840	Exon 9
<i>vtg3</i> ^{-/-}	-----	339	
<i>vtg3</i> ^{+/+}	TGGAGGTAACAGATGAAAGAATTCTCAAATTCCTTGAGGCCAGATACAAAGCAGGAGACA	6900	
<i>vtg3</i> ^{-/-}	-----	339	
<i>vtg3</i> ^{+/+}	TCACAGCGAATGAGGCAGGACAAGCACTGGTAGTGGCATTAAACCACTTGTCGCTGAGC	6960	
<i>vtg3</i> ^{-/-}	-----	339	
<i>vtg3</i> ^{+/+}	CTGTGTCGGTGGCATTAGCTCAGTGTGAGACAGTGACCAAGTTAAATGTATGTTAGAATCC	7020	Intron
<i>vtg3</i> ^{-/-}	-----	339	
<i>vtg3</i> ^{+/+}	TTTTTTATCTGCCGCTCTGATACGCTTCCGCTCTCCAGGAGTTCTGACCATTCTTTTC	7080	Exon 10
<i>vtg3</i> ^{-/-}	-----	339	
<i>vtg3</i> ^{+/+}	AGTAAATCCCATCCTCTCCTGTGGAACACTGTAGTTTTGGCATATGGATCTCTGTACAC	7140	
<i>vtg3</i> ^{-/-}	-----	339	
<i>vtg3</i> ^{+/+}	AGATACTGTGTGATACTGACCCCTGCCCTATCACTGTGGTACAGGATCTGAGATGTCC	7200	Intron
<i>vtg3</i> ^{-/-}	-----	339	
<i>vtg3</i> ^{+/+}	TACACCTCTATGTTGATTGATTCATACACCTATCATAGTAATATTTTGTAGTTTTATGT	7260	
<i>vtg3</i> ^{-/-}	-----	339	
<i>vtg3</i> ^{+/+}	CAAACCTAGTTCTTTGATATTTACAGTACATCTCACTGCTTTTTGTACATACTATTGTTT	7320	
<i>vtg3</i> ^{-/-}	-----	339	
<i>vtg3</i> ^{+/+}	AGCCATTGCTGAATATGGCTGCAAGTAGCCTAAGTAAAACTCTGAGGATGAAATGGTCC	7380	Exon 11 (sg33)
<i>vtg3</i> ^{-/-}	-----	357	
<i>vtg3</i> ^{+/+}	TTGCGCTGAAGTCCTTGGGAAACGCAGCTCATCTTCCAGCTTCAAGACTCTCCTCAAGT	7440	

<i>vtg3</i> ^{-/-}	-----	417	
<i>vtg3</i> ^{+/+}	TCCTTCCCTGGATACTCCAATGGAGCTGAAAAACTTCCACCAGAGTGCAGGGAGCTGCAG	7500	

C) *vtg1*-KO

>*vtg1*-KO_mRNA

UUAUUCCUCCUUGAUUAUUUCUGGAUCCAGGCGAGAAAGUCUUCAUAGGUCUCAUUGGAAAAAGUCCGUCUGGAUUGA
UGGGAACAGCGACAGGAAGAUAAAUAUCCCUUUUUUGACAUUGUGAUCUCUGGAAUCCUAGCAAUGAUUAUCAAGGACCUC
UGAGAUGGCAAGGCUCGAGUCAGUUCAAUCUCUUUCUCGUCGUUCGUUGCUCGUUCAAAACCUGAAUCCUGUGUCGUAAGC
UGCUGUAAGGAUGUGUUUACCCAGCUUUUUGGCAUAGGUGGUGACAAUUAUUGGCAGUCUCUCCAUUCCACUUCUAGAC
GUGCAGCAGGGAAUUCACCCAGGACACCAGCUUCAGCUUAGCAAAGACUGCAUACUGUUUGCACUCCGCACCCCAAGAA
AACUUGCCAGUAACUUUGUGCUUGCUC AACAGAGCACCAUCAGCACAGAUUUCAUGUUGUCGUUUUCAGCAAUGGAGGA
AACUAUCAGUUGCACUCUUGCAGUUGGUUUGUCAAAAGUAAGCAGCCAGUUGGUAGCCAGAAGCUUCUGGUCAGCUCUAA
CAGCACGGGCGAUGAUAGCAAAAACAGGUGGAAUAUCAUUUCCAAGGAAUCUAUUCUGUUUCUGCAUUUGUCAAAGCUA
GCUGCAGCACUUCACUGCUAGUAUCCUUUGUGGGCGUAUGGUGUGCCAAGUACCGAUCUUUGUGGAAUUUCCUGAAAGG
CUCAAUGAUGGUGGAGUCUUAAGACAUACGAGAGCUGGACAUAGAGGAGCUUGAGCUUGAACUUGAACUUGAACUUGAGC
UUGAGCUUGAGCUGGUGCUAGUGCUGGUGCUGCGGCUCGUCGUCGUCGUCGUCGUCGUCGUCGUCGUCGUCGUCGUCGUCG
ACAGGUGCAUUUUUAGCUUCAGUGUCCAGGAUUUCCUCAGUUUCAACAAGAAAGCCUGUCCUUCUGGAGUAUCAUCAUC
AAUGAUGUUGAUUUGCUUAACAAGCCUCUCAGCAGCUCUAGGACCAACUUGAACUUCAAACUCCAGUCUUUCAACUGCAG
GACCUUCAGCUCUUGCCACUGCAGCACGGACUGAGUGGUGUCCAUAUUGUAGAAAAGAGUGGAAUUUCUGAUAAAAGCA
GCAUUGUGAGAGUGCACCUCAACACAUCCCUUGAUUUCAAUGUAUGGGACAGCAUAACAGAGGGUUCUGUCAAAUGGAGC
AGGAGCUCUUACUGAAGCAACAGAUAGACAUCUCAGAUGACAAAUCACCAGCAUAAGAUGCCUGGGAGUUUUGCAGAGACA
AUUCAGGUACCAGGGGAACAGACCUUUCAGCACUGUGAUCUCAAUGUUUCUGACCACGGCAUAAGUCUCAAAAGCUUGCA
GAAGCAAUGUGUUCAGGAAGUUAACAGGCAGAGCCUCCACCUUGUAGUUGCCCUUGAGAAUGUCUGCUCUUGCUGCCAC
UUUUCGGGUGCAAUUGUACGGAUUUUCCUCUUGCCAUAACAGCAGCUUGGAUGAAGGCAGUGUUAACUCCCAUCACAG
CAAUGUCUGGAGAGCAACACUUGGUCUAGCUUCAGCUUGGAACUGAACAUUCAGUCUUCUUUAGUUGCUCAUAAGUCAUG
GACUCCAAUUUCUCAGGGAGAGCAGGUGUAUUGGUGGCCUGAACAUUGACACUUGCAGCAGCAACUGCAGCAGUGUACCA
ACUGAACUCCAUGGGCACACCAACUGCAGUUGGCAAGAUGCGACGCACUUCAGCUGCAAGCAAAGGUUUAGCAUACUGGA
AGGCAACUCCUUCUGCAAAGCUUUAAGAGCCUCCUUCAGCAGUGCAGGUGUUGGGUCCAGUAGCCAU <703 bp>
AUGGCAUCAACCUGGACUCUAAUGGGCAAAGCAUAGCUGCAGUUCUCAGUCCAGGAAGGAGCUUCAUGAUUGGCUUAAG
ACUUGAAGGGUGACCAGCAUUGCCCAUAACUUUCAGAGCCAAAGUGAUUUCAGGAAUGUCAUUCUUAGAAAUGGCCUCUG
UGGCGAUCUCGUGGAUGGGCCUGAGGAGCUCAGCAGGGCAAGUGGGAAUCUGCAACACAGUAUUUGGCAAUCAGGGAACCA
UAUCCAAGCAUGACAACUUCACGCAGAGCUGGGAUUGUGGCAAUUUCUAGAGUAGCCAAACUAGCUGUCAUUUUAU
GGUUUCAGGAUCAGCAGUGACCAUUUGCAGAGCAAUCACAAGAGUCUGAAUGAACUCGGGAGUGGUAAAUUCACCAGCCA
GGAACUUCUCCUUGAUGAAUUUUAUAAUGACUGGUGUACCAACAGCAGGAAGAGCAUCCAGAAGCCAGCGCCUGUAAACU
GGUUUGUCCUUGAACUGAGACCAGAUAGCCUCAAUUUUCUCCAAGGAGGCAACACGCAAGAGCUGGACAAGCUGAACAAA
CUUGAAUGGAGCAUCAUCAUGGACCAUGUCUUUAUUGUUUGAAACCAAGUGCUUCAGGACCUCGACAAUCUGGGCAGGUG
CAUCACUGAUCUUCUAGAGUUGAAUGGGGGUCUGAAGAAUCUCAGUUGCAAACUCGUACUGCAGGGAUCCACGGGGCAUG
UAAUCAGCUUUGAUUGGAACGACAGGGGUCUUCUCAAUCUCAACAAAAGCCAAGGUUUUGUUUUGCUUCAUCAUUGCAGC
ACCAUGAAUCUCAUUGAAGGGUGAGAACUGAUACACUUCUCAAUCUGUUGCCUCAGCGAUCAGUGCACCAUUGUCAGCUG
GUUUCAGAUUGUAGUUAUAAUGUUGCAGUUCAAUCAGACUCUUGACCCUCUCUGUGCAUUCAGCACACCUCUCAGUGUAU
GCCAAGCCAACAUCUUCUUGAUCUUCUCCUGGCAGUGGCUCAGAUUUUAGACUUUGUCACAAUAAUGUGGUUGGCCUU
UGGAUCCUCAUUGAUGACAUGUGUGUUCUGCACACUCCUGAGCUCAGCCUCUUGCAUCUCGUAGAUGUUCUGGGUCU
UCUUGAGGUUGAGCUGAAGGAUGUUGAGGAUACCUCUGUGCAAGUUCAUGACUGUAGGAGAGACUCCUGCUGGGGCAAAA
ACCUUGCCAACCACACCAUAGCAUACUCAACUUGAUGGGAAUCUGAAGCUGAGCAGCCAGUGCUGAGGUGAGCUUAGU
AGCAGGAACAAAUGGAUCCUUGGGCCAAGUGCCAGCAUACUCGUAGAGUAGAGGAUCCAUAAAGCUUCAUCAGGUAGGUU
UCUCUGUCGUGGCACUGAUGAGAACCUUGCUGCUGACUUUAAUACCUGCUCUGGCCAGACCUUCUUGAGGAAGACCUC
AAAAGCAGAGCCUCAUACUUGUACACAUAGGUCUUAUCAUGGGCAAACUCAGGAACAAGGUUGAAUUGUUGACAUGCCAC
GAGGGCUACAGUCAAGGCAAGCACAACAGCUCUCAU

D) *vtg3*-KO

>*vtg3*_mRNA

UUAAGUUGACAUGGUGAGAUUUGCAGCUUCGAUCCCCAAAAGUUCAAUUGGUGAGGGAAUUUUCUUUUUGUAGAUAGUUCGC
UCUGGAAUUUCACUUUCAGGUCAAAGGUCUCUGGUGAGGAUGCUACAACGAUGACAGAUGCCUGCCGUUCUGGGUUUUCU
CCUUUUUCUGGUAGAAACCCAUAAUGUAAGACACGCCAGGUACAUAUCUCUUGAACUAUUUGACCAACUGUUGUGAAUACUGA
GGGCAGAGUCCCCAGUUAUUCUUUGUGCUUAUAGAUUGGUUUGGACUCUGGUUGGCACGCUGCGGACACUCUCAUAGAAACA
UCAUAUGUUUGACACUCUGCACCCCAUCUGAGAUGAGCCUUUGCUGAUGUAUGAGUCUUAUCAAAAUGUGCAUUGGCACACA
UUUUCAGUUUGCUUCUUCACCAACUUCAGAGACGAUCAUUCAAUGUCGUCUUUUUGGGCAGUUGGCAGAUAAAAGGCUAC
GCCUUCAUAGCCAAGGGGUUUUGCUUGUGGACUUAACUAAGUCUUUACUGUGACUACCGGGUCUGGAGUGACAUCUAGA
UCCUGAGUUACUGGGAGUGAACUGGAUGUUUUGCGUUCUCACAGGAGGUGUUCUCAUCUCUUGUCUCCUUAUUUACCCUUU
GGUUGAGAUUCACCAUUCACUCAUACUGAAGGAUGUUGUCUGCUGGCAGAGACCUGAAUCUGAAUUUUUCAAUGGGUUU
UGCAUCCUUUGCUGGUUCUAAACUGUAUGAAAAGUGAGUAUCACCCAGUAAGUAAUACAGAGGAUAUUCGUGAAGAUAGUGU
GCACGUUUGGCUUCUGCCUCAUUGCAGAGUGCAGUUCCAUAAAUUUUGGCUUCAGCACAUUGCCUGAAUUUCAUUCAGAUU
UUUUGGUCUGUUCAUCCCUUAAAGGGGGUAACAUCUCAGAGGCACACCCUGCCAGGACUCCCUUGUCUCAGGCAUCAUGGG
UGUUUUUUAGAUGAGGUUGGGUCUCAAUGUUUCUCAAACAGCAUACACAUAAGAUCUGACUGAAAAUAAUUCGGUGACC
GAUUUGCUUGGAGUCAAGUUCAUUUCAUACGUUUGCUCUUUCGGAUUUUUUUCAGGUCAAUUGCCCACGGCAGGCCCAUUG
AAACCUUACUUUUCAGCUCAGUUCACACUGAAAAAGAUCAUGUUGAUUCCAUGGAAGAGAAAAUGAUCCUUUGUCACGCC
GAUAAAGCCAUCUGUCUGCAUGGAAAUGUCUGAGCUUAGCAGUUCACCCAGAUUUCUUGGAGGAGGAUUUAUUUCAGCU
UUUGCUUUCAUUGUAACAGCAUUUACUACGGAAUAAUAAUUGCUGAUUUAACUGGGAGACCCAGACAUGUCGGCUGUAUGA
ACCGAGCCUCAUACACAAGAUGCGGCUUAGUCCAGUGCCAUGAAGUCCCUUUCUGAACAUUCUUGAAUCCUUUCCCAAACUUU
ACUCUCCUUUCCUGCAGAAGGACUGAAAGACUUUAUGAUGCUUUGAACUGAGUCUCUGCUUACAUCCAUUA AAAAGGCUUC
UGUCCAAAAACUCUUGCAUAAGCUGUCAAAAGAGGCCUUGUCUUUUGGUAGGCUCUGCCAGUUAGAGAGAAUUUCAAUAUGG
AAGCCAAAUCGCUGAUUCCUAAAUCUUUCGUGAGUUCUGGGAUUUUUCCAGCAAACAGAUUCUUGAGUCCAUCUGCACGGAU
ACCAAACUCAAGAAAUUGCAGUAUUCUCCCAAUGAAAUGAAUUUUUCCCUUAAGCAUAAGUUUUGUGGGGAUGGGACUUUCA
UUCUGAAGCAUAUAAAACUACAGCAGAUGUCCAAAUA AAAAGUCAUCAUGGAACCAGUCAAAAGUGCAGGUUCUUGCUGUAGC
GGUAACUCAAGUGGCCAAGUUUACGGGUUAGAAUCUUCUUGGCAAUAUUACAGGCAAUAGAUAGAUUGUUAUUCAGGGGU
ACGGGACUUGGCAAAGCCUUUGAGCAGAGAGUAGGAGAAACUGGCAACCUGCAGAUACGCCUCUUCUAGAAGGACCUCACUU
ACUACUGAAAUCAGAGCUGUGGACGGCUUGGUCUCUAGAAGAACUUAUGCAGGCCAGCAUGCGGAUUUCAGCUGGUAAAUGU
UCUGUACGAAGAGGUUUUAAAGACAUAUCCUGUACACUGUGGGAGGCUCUGCUUGCAAGCAGCCUAAAUGCUUGGACUGCAGC
UCCUUGCACUCUGGUGGAAAGUUUUUUCAGCUCUUAUGGAGUAUCCAGGAAGGAACUUGAGGAGAGUCUUGA <714 bp>
GGAAGUUUCCUCCCUUUAUUGAACGGAGAGAAAUAUUGGCGCUCUUGAGCAAUUGCUUUAGUAAUUCUGACCACCGUCUGC
UGUGGACUUCACUGUGUAGGUGUGUUUCACAGUGGAAACAACGCUUUCGCCUCUCUGUUUGCUAAGUUUGUCUUCAGGUGCA
AGAGCCAUACCUCUGUACAAAGAUGCUGGCUGUUGACAGUUGGUGAUUAACAACAAUUCGUGUUACUAUCAACUCUUUUGCGU
UAGAGUCUUCAUCAACAGUGUAACUGCUCUGACACAAACCAUGAAUUC CCAACUCAAUUAGUUCGUAAAAACUUUGUGUGGU
UUUGACCGUGACUUGUAAAAUCCAAGGAUCCCCUCACAAUAUUCACAACUGUGUUUGAGACUCCAGGUGCUGUGCGAAUG
UCAGUAAUUUGUCCUUUAGAAUAUUCAAAAUUGAUUGGCUGGCUGAUCUCGGCAGACAGAUUCUAGUGAUGUUUUUGGAAG
GGCUGAAGACACUUUCCAGGUAUGCCAUAUAAAUCUUCAAAGUCUACAUUUGAGACCUGAAGGACAAAGGUGUGUGGUGA
CUCUCCAAUGAUUUUAAAAGUGCACCUCAGUUUCAGCGCUGAUUCAACCAGGUGUGGCAGUUC CCGUCCCAUUGUACCAAU
CCUUCAUUUUAUACUCGUAGUUUUUUCGAGUUCAGAAAAGGCUCAUAAUUGCCAU

E) vtg1-KO

>vtg1-KO_reverse complementary cDNA

ATGAGAGCTGTTGTGCTTGCCTTGACTGTAGCCCTCGTGGCATGTCAACAATTCAACCTTGTTCCTGAGT
TTGCCCATGATAAGACCTATGTGTACAAGTATGAGGCTCTGCTTTTGGGAGGTCTTCCTCAAGAAGGTCT
GGCCAGAGCAGGTATTAAAGTCAGCAGCAAGGTTCTCATCAGTGCCACGACAGAGAATACCTACCTGATG
AAGCTTATGGATCCTCTACTCTACGAGTATGCTGGCACTTGGCCCAAGGATCCATTTGTTCTGCTACTA
AGCTCACCTCAGCACTGGCTGCTCAGCTTCAGATTCCATCAAGTTTGTAGTATGCTAATGGTGTGGTTGG
CAAGGTTTTTGGCCCAGCAGGAGTCTCTCCTACAGTCATGAACTTGCACAGAGGTATCCTCAACATCCTT
CAGCTCAACCTCAAGAAGACCCAGAACATCTACGAGATGCAAGAGGCTGGAGCTCAGGGAGTGTGCAGAA
CACACTATGTCATCAATGAGGATCCAAAGGCCAACACATTATTGTGACAAAGTCTAAAGATCTGAGCCA
CTGCCAGGAGAGAATCATGAAGGATGTTGGCTTGGCATACTGAGAGGTGTGCTGAATGCACAGAGAGG
GTCAAGAGTCTGATTGAACTGCAACTTATAACTACATCATGAAACCAGCTGACAATGGTGCACCTGATCG
CTGAGGCAACAGTTGAGGAAGTGTATCAGTTCTCACCTTCAATGAGATTTCATGGTGTGCAATGATGGA
AGCAAAACAAACCTTGGCTTTTTGTTGAGATTGAGAAGACCCCTGTCGTTCCAATCAAAGCTGATTACATG
CCCCGTGGATCCCTGCAGTACGAGTTTGAACCTGAGATTCTTCAGACCCCATTCAACTCATGAAGATCA
GTGATGCACCTGCCAGATTGTGCGAGGTCCTGAAGCACTTGGTTTCAAACAATAAAGACATGGTCCATGA
TGATGCTCCATTCAAGTTTGTTCAGCTTGTCCAGCTCTTGGTGTGCTCCTTGGAGAAAATTGAGGCT
ATCTGGTCTCAGTTCAAGGACAAACCAGTTTACAGGCGCTGGCTTCTGGATGCTCTTCTGCTGTTGGTA
CACCAGTCATTATAAAATTCATCAAGGAGAAGTTCCCTGGCTGGTGAATTTACCACCTCCCGAGTTCATTCA
GACTCTTGTGATTGCTCTGCAAATGGTCACTGCTGATCCTGAAACCATTAAAATGACAGCTAGTTTGGCT
ACTCATGAGAAATTTGCCACAATCCAGCTCTGCGTGAAGTTGTGATGCTTGGATATGGTTCCCTGATTG
CCAAATACTGTGTTGCAGTTCCCACTTGCCCTGCTGAGCTCCTCAGGCCATCCACGAGATCGCCACAGA
GGCCATTTCTAAGAATGACATTCTGAAATCACTTTGGCTCTGAAAGTTATGGGCAATGCTGGTCAACCT
TCAAGTCTTAAGCCAATCATGAAGCTCCTTCTGACTGAGAACTGCAGCTAATGCTTTGCCATTAGAG
TCCAGGTTGATGCCAT <703 bp> ATGGCTACTGGACCCAAACCACGTGCACTGCTGAAAGGAGCTCT
TAAAGCTTTGCAGGAAGGAGTTGCCTTCCAGTATGCTAAACCTTTGCTTGCAGCTGAAGTGCCTGCATC
TTGCCAATGCAGTTGGTGTGCCATGGAGTTCAGTTGGTACACTGCTGCAGTTGCTGCTGCAAGTGTCA
ATGTTTCAAGGACCACTTACACCTGCTCTCCCTGAGAAATTGGAGTCCATGACTTATGAGCAACTAAAGAA
GACTGATGTTTCAAGCTGAAGCTAGACCAAGTGTGCTCTCCAGACATTTGCTGTGATGGGAGTT
AACACTGCCTTCATCCAAGCTGCTGTTATGGCAAGAGGAAAGATCCGTACAATTGCACCCGGAAAAGTGG
CAGCAAGAGCAGACATTCTCAAGGGCAACTACAAGGTGGAGGCTCTGCCTGTTGAACTTCTGAAACAT
TGCTTCTGCAAGCTTTGAGACTTATGCCGTGGTCAAGAACATTGAAGATCACAGTGTGAAAGTCTGTT
CCCCTGGTACCTGAAATGCTCTGCAAACTCCAGGCATCTTATGCTGGTGAATTTGCTCATCTGAGATGT
CATCTGTTGCTTCAAGTAAAGCTCCTGCTCCATTTGACAGAACCCTCTGTTATGCTGTCCATACATTGA
AATCAAGGATGTGTTGAGGTGCACTCTCACAATGCTGCTTTTATCAGAAATTCACCTCTTTTCTACATA
ATTGGACACCACTCAGTCCGTGCTGCAGTGGCAAGAGCTGAAGGTCCTGCAGTTGAAAGACTGGAGTTT
AAGTTCAAGTTGGTCTAGAGCTGCTGAGAGGCTTGTAAAGCAAAATCAACATCATTGATGATGATACTCC
AGAAGGACAGGCTTTCTTGTGAACTGAGGGAAAATCCTGGACACTGAAGCTAAAATGCACCTGTTTCT
TCTGAAAGCAGCAGCAGTCGTAACAGTCGCAGCAGCAGCAGCCGACAGCAGCAGCAGCAGCAGCAGCAGC
GCTCAAGCTCAAGTTCAAGTTCAAGTTCAAGTTCAAGTTCAAGTTCAAGTTCAAGTTCAAGTTCAAGTTCA
TGCCACCATCATTGAGCCTTTTCAAGAAATTCACAAAGATCGGTACTTGGCACACCATAGCGCCACAAAG
GATACTAGCAGTGGAAAGTGTGCACTAGCTTTGAACAAATGCAGAAACAGAAATAGATTCCCTGGAAATG
ATATTCACCTGTTTTTGTATCATCGCCGTGCTGTTAGAGCTGACCAGAAGCTTCTGGGCTACCAACT
GGCTGCTTACTTTGACAAACCAACTGCAAGAGTGAAGTATGATGTTTCTCCATTGCTGAAAACGACAAC
ATGAAGATCTGTGCTGATGGTGTCTGTTGAGCAAGCACAAAGTTACTGGCAAGTTTTTCTTGGGGTGC
AGTGCAAAACAGTATGCAGTCTTTGCTAAAGCTGAAGCTGGTGTCTGGGTGAATTCCTGCTGCACGTCT
AGAAGTGGAAATGGGAGAGACTGCCAATAATTGTCACCACCTATGCCAAAAGCTGGGTAAACACATCCTT
ACAGCAGCTTACGACACAGGATTCAGGTTTGAACGAGCAACGAAACAGCGAGAAAGAGATTGAACTGACTG
CAGCCTTGCCATCTCAGAGGTCCTTGAATATCATTGCTAGGATTCAGAGATCACAATGTCAAAAAGGGA
TATTTATCTTCTGCTGCTGTTCCCATCAATCCAGACGGAACTTTTCCATTGAGACCTATGAAGACTTT
CTCGCTGGATCCAGAAATATATCAAGGAGGAATAA

RbD / RbM

F) vtg3-KO

>vtg3-KO_reverse complementary cDNA

ATGGCAAATTATGAGCCTTTTCTGAACTCGAAAAAACATACGAGTATAAAATATGAAGGATTGGTACAAGT
GGGACGGGAACTGCCACACCTGGTTGAATCAGCGCTGAAACTGAGGTGCACCTTTTAAATCATTGGAGAGT
CACCACACACCTTTGTCTTTCAGGTCTCAAATGTAGACTTTGAAGATTTTAAATGGCATACTGGGAAAAGT
GTCTTCAGCCCCTTCCAAAACATCACTAAGCATCTGTCTGCCGAGATCAGCCAGCCAATCATTTTTGAATA
TTCTAAAGGACAAAATTAAGTGCATTCGCACAGCACCTGGAGTCTCAAAACAGATTGTGAATATTGTGAGGG
GGATCCTTGGATTTTTACAAGTACGGTCAAACCACACAAAGTTTTTACGAACTAATTGAGTTGGGAATT
CATGGTTTGTGTGTCAGAGCAGTTACACTGTTGATGAAGACTCTAACGCAAAAAGAGTTGATAGTAACACGAA
TGTGATATCACCAACTGTCAACAGCCAGCATCTTTGTACAGAGGTATGGCTCTTGCACCTGAAGACAAAAC
TTAGCAAACAGAGAGGGCGAAAGCGTTGTTTCCACTGTGAAACACACCTACACAGTGAAGTCCACAGCAGAC
GGTGGTCAGATTACTAAAGCATTTGCTCAGGAGCGCAATATTTCTCTCCGTTCAATGTAAAGGGAGGAAA
CTTCC <714 bp> TCAAGACTCTCCTCAAGTTCCTTCTGATACTCCAATGGAGCTGAAAAACTTTCCA
CCAGAGTGCAGGGAGCTGCAGTCCAAGCATTTAGGCTGCTTGCAGCAGAGCCTCCACAGTGTACAGGAT
ATTGCTTTAAACCTCTTCGTACAGAAACATTTACCAGCTGAAATCCGCATGCTGGCCTGCATAGTTCTTCT
AGAGACCAAGCCGTCCACAGCTCTGATTTTCAAGTAGTAAGTGAAGTCCCTTAGAAGAGGCTGATCTGCAGG
TTGCCAGTTTCTCTACTCTCTGCTCAAAGGCTTTGCCAAGTCCCGTACCCCTGATAATCAACATCTATCT
ATTGCTGTAATATTGCCATGAAGATTCTAACCCGTAACCTTGGCCACTTGAGTTACCGCTACAGCAAGAA
CCTGCACCTTGTACTGGTTCCATGATGACTTTTTTATTTGGGACATCTGCTGATGTTTATATGCTTCAGAA
TGAAGTCCCATCCCCACAAAACCTTATGCTTAAGGAAAATTTTCAATTTTATTGGGAGAATACTGCAATTTCTT
GAGTTTGGTATCCGTGCAGATGGACTCAAAGATCTGTTTGTGCGAAAATCCAGAACTCACGAAAGATTT
AGGAATCAGCGATTTGGCTTCCATATTGAAAATCTCTCTAACGTCAGAGCCTACCAAAAGACAAGCCTC
TTTTGACAGCTTATGCAAGAGTTTTTGGACAGGAAGCCTTTTTAATGGATGTAAGCAGAGACTCAGTTCAA
AGCATCATAAAGTCTTTCAGTCTTCTGCAGGAAAGGAGAGTAAAGTTTGGGAAAGGATTCAAGATGTTCA
GAAAGGGACTTCATGGCACTGGACTAAGCCGCATCTTGTGTATGAGGCTCGTTTATACAGCCGACATGTC
TGGGTCTCCAGTTGAAATCAGCAAATATTATCCGTAGTAAATGCTGTTACAATGAAAGCAAAGCTGAA
ATAATCCTCCTCAAAGGAACATCTGGGTGAAGTGAAGCTCAGACATTTCCATGCAGACAGATGGCTT
TATCGGCGTGACAAAGGATCATTTTCTCTTCCATGGAATCAACACTGATCTTTTTTCAAGTGTGGAAGT
TGAAAAGTAAGGTTTCAATGGGCTGCGGTGGGCAATTTGACCTGAAAATAAATCCGAAAAGACAAACGAT
GAAATGAACCTTCAAGCAAATCGGTACCGAATTTATTTTCAAGTCAAGTCTAATGTGTATGCTGTTTTT
GAGAAACATTGAAGACCCAACTCATCTAAAATAACACCCATGATGCCTGAGACAGGGGAGTCTTGGCAGG
GTGTGCCTCTGAGAATGTTACCCCTTTAAGGGATGAACAGACCAAAAAATCTGGAATGAAATTCAGGCAA
TGTGCTGAAGCCAAAATTTATGGAAGTGCATCTGCATTGAGGCAGAAGCCAAACGTGCACACTATCTTCA
CGAATATCCTCTGTATTACTTACTGGGTGATACTCACTTTTATACAGTTTGAACCAGCAAAGGATGCAA
AACCCATTGAAAAAATTCAGATTCAGGTCTCTGCCAGCAGACAACATCCTTCAAGTAAATGAGTGGAAATGGT
AATCTCAACCAAAGGTTATTTAAGGAGACAAGAGATGAGAACACCTCCTGTGAGGAACGCAAAACATCCAG
TTCATCCCAGTAACTCAGGATCTAGATGTCACTCCAGACCCGGTAGTCACAGTAAAAGCACTTAGTTTAA
GTCCACAAGCAAAACCCCTTGGCTATGAAGGCGTAGCCTTTTATCTGCCAATGCCCCAAAAGACGACAT
GAAATGATCGTCTGAAAGTTGGTGAAGAAGCAAACCTGGAAAATGTGTGCCAATGCACATTTTGATAAGAC
TCATACATCAGCAAAGGCTCATCTCAGATGGGGTGCAGAGTGTCAAACATATGATGTTTTCTATGAGAGTGT
CCGCAGCGTGCCAAACAGAGTCCAAACCATCTATAAGCACAAAGATTAAGTGGGGACTCTGCCCTCAGTA
TTCACAACAGTTGGTCAAATAGTTCAAGAGTATGTACCTGGCGTGTCTTACATTATGGGTTTCTACCAGAA
AAAGGAGGAAAACCCAGAACGGCAGGCATCTGTCTGTTGATCCTCACCAGAGACCTTTGACCTGA
AAGTGAATAATTCAGAGCGAACTATCTACAAAAGAAAATTCCTCACCAATTGAACTTTTGGGGATCGAA
GCTGCAAACTCACCATGTCAACTTAA

RbD / RbM

G) vtg1-KO

LvH1 Pv1 LvL1

5' MRAVVLA **IVTKSKDL** REILDIT RMSKTAT 3'



Frame 1 5'>3'

|MRAVVLA LTVL VACQ FNLVPEFA HDKTYVYKYEALLLGGLPQEGLARAGIKVSSKVLISATTENTYLMKLM D
PLLYEYAGTWP KDPFVPATKLT SALAAQLQIP IKFEYANGVVGKVFAPAGVSPTVMNLHRGI **LNIQL** NLKKTQ N
IYEMQEAGA QGVC RTHYVI **NEDPKANHI IVTKSKDL SHCQERIMKDVGLAYTERCAETERVKS LIETATYNYIM**
KPADNGALIAEATVEEVYQFSPFNEIHGAAMMEAKQTLAFVEIEKTPVVP IKADYMPRGSLO YEFATEILOTP IQ
LMKISDAPAQIVEVLKHLVSNKDMVHDDAPFKFVQLVQLLRVASLEKIEAIWSQFKDKPVYRRWLLDALPAVGT
PVI IKF I KEKFLAGEFTTPEFIQTLVIALQMV TADPETIKMTASLATHEKFATIPALREVVM LGYGS LIAKYCVA
VPTCPAELLRPIHEIATEAISKNDIPEITLALKVMGNAGHPSSLKPI MKLLPGLRTAANALPIRVQVD AI <234aa>
WLLDPNHVHC -RRLKLCRKELPSSMLNLCLQLKCVASCQLVCPWSSVGTLLQ LLLQVSMFRPPLHLLSLRNW
SP -LMSN -RRLMFSSK LKLDQVLLSRHLL -WEL TLPSSK LLLWQEERSVQLHPEKWQEQTF SRATTRWRLLCN
FLNTLLLQALRLMPWSETLKITVLKGLFPWYLNCLCKTPRHLMLVICHLRCHLLQ -ELLHLTEPSVMLSHTLK
SRDVL RCTLTMLLLSEIPLFST -LDTTQSVLQWQELKVLQ LKDWSLKFKLVLELLRGLLSKSTSLMMILQKDRLS
C-N -GKSWTLK LKMHLFLLKAAAVVTVA AAAAAAPALAPAQAQAQVQVQVQAQAPLCPALVCLRLPPSLSLGSNS
TKIGTWH TIAPQRI LAVEVLQALNKCNRNIDSLEMIFHLFLLSSPVLEL TRSFWATNWLTLTNQLQECN --F
PPLLKTTT -RSVLMVLC -ASTKLLASFLG VRSANSMQSLLK LKLVSWVNSLLHV -KWNGRDCQ -LSPMPKSWVN
TSLQQLTTQDSGLNEQRTARKRLN -LQPCHLRGP -ISLLGFORSQCQKGFIFLSLFP SIQTELFPLRPMKTFSP
GSRNISRRN

Rbd/Rbm
anti-zflvH1
epitope

Frame 2 5'>3'

-ELLCLP-L-PSHWVNNSTLFLSLPMIRPMCTSMRLCFWEVFLKKVWPEQVLKSAARFSSVPRQRIPT--SLWIL
YSTSMALALGPRIHLFLLSSPQHLLSFRFPSSLSMLMVWLARFLPQ QESLLQS -TCTEVSSTSFSSSTRRPTS
TRCKRLELRECAEHTMSSMRIQRPTLL -QSLKI -ATARRES -RMLAWHTLRGVLNAQRGSRV -LKLQ LITTS -N
QLTMVH -SLRQQLRKCIS SHPSMRFMVLQ -WKQNKP WLLLRLRRPLSFQSKLITCPVDPCSTSLQ LRRFPFNS
-RSVMHLPRLSRS -STWFQTIKTWSMMMLHSSLSLSSCVLPPWRKLRSLGSSRTNQFTGAGFWMLFLLLVHQ
SL -NSSRRSSWLVLNPLPSSFRLL -LLCKW SLLILKPLK -QLVWLLMRNLPQSOLCVKLSCLDMVP -LPNTVLQF
PLALLSSSGPSTRSPQRPFRLMTFLKSLWL -KLWAMLVTLQVLSQS -SSFLD -ELQLMLCPLESRLM <234aa> PY
GYWTQTCTAEGGS -SFAGRSCLPVC -TFACS -SASHLANCSWCAHGVQLVHCCSCCKCQCSGHHYTCSP -EIG
VHDL -ATKED -CSVPS -S -TKCCSPDICDGS -HCLHPSCCYGKRKDPYNCTRKSGSKSRHSQGQLQGGGSAC -T
S -THCFCKL -DLCRGQKH -RSQC -KVCSPGT -IVSAKLP GILCW -FVI -DVICCFSKSSCSI -QNPLCCPIH -N
QGMC -GALSQCCFYQK FHSFLHNWTPSPCCSGKS -RSCS -KTGV -SSWS -SC -EAC -ANQHH ---YSRRTGFL
VETEGNPGH -S -KCTCFF -KQOQS -QSQQOQPHQH -HQLK LKLFKFKFLKLLYVQLSYV -DCHH -AFQEI P
QRSVLGTP -RHKG Y -QWKCCS -L -TNAETE -IPWK -YSTCFYHRPCC -S -PEASGLPTGCLL -QTNCKSATDSF
LHC -KRQHEDLC -WCSVEQAQSYWQVFLGCGVQTVCSLC -S -SWCPG -IPCCTSRSGMGETANNCHHL CQAG -T
HPYSSLRHRIQV -TSNEQRERD -TDCSLAISEVLEYHC -DSRDHNVKGYLSSCRC SHQSRRNFFH -DL -RLSRL
DPEIQGGI

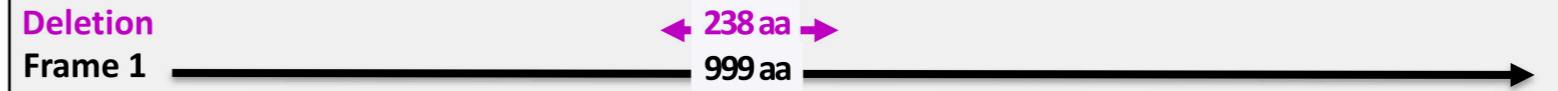
Frame 3 5'>3'

ESCCACLD CSPRGMSTIQPCS -VCP --DLCVQV -GSAFGRSSRRSGQSR Y -SQQGS HQCHDREYLPDEAYGSS
TLRVCWHLAQGSICSCY -AHLSTGCSASD SHQV -VC -WCGWQGF CPSRSLSYSHELAQRY PQHPSAQPQEDPEHL
RDARGWSSGSVQNTLCHQ -GSKGPHYCDKV -RSEPLGENHEGCWLG I H -EVC -MHREGQESD -NCNL -LHHET
S -QWCTDR -GNS -GSVSVLTLQ -DSWCCNDGSKTNLGF C -D -EDPCRSNQ S -LHAPWIPAVRVCN -DSSDPHSTH
EDQ -CTCPDCRGPEALGFQ -RHGP --CSIQVCSACPALACLLGEN -GYLVS VQGQTS LQALASGCSSCCWYTS
HYKIHQGEVPGW -IYHSRVHSDSCDCSANGHC -S -NH -NDS -FGYS -EICHNPSSA -SCHAWIWFDCQILCCSS
HLPC -APQAHPRDRHRGHF -E -HS -NHFGSESYGQCWSPFKS -ANHEAPSWTENCS -CFAH -SPG -CH <234aa> M
ATGPKPRALL **KEALKAL** QEGVAFQYAKPLLAEEVRRILPTAVGVPM EFSWYTA AVAAASVNVQATITPALPEKLE
SMTYEQ LKKT DVQFQAEARPSVALQTFVAMGVNTAFIQAAVMARGKIRTIAPGKVAARADILKGN YKVEALPVEL
PEHIASASFETYAVVRNIEDHSAERSVPLVPELSLQNSQASYAGDLSSEMSSVASVRAPAPFDRTL CYAVPYIEI
KGCVEVHSHNAAFIRNSTLFYIIGHHSVRAAVARAEGPAVERLEFEVQVGPRAAERLVKQINI IDDDTPEGOAFL
LKL | REILDTEAKNAPVSSSSSRNSRSSSRSTSTSTSSSSSSSSSSSSSSSSSSSSSSSSSS | RMSKTAT IIEPFRK
FHKDRYLAHHSATKDTSSGSAASFEQM QKQNRFLGNDIPPVFAI IARAVRADQKLLGYQLAAYFDKPTARVQLI
VSSIAENDNMKICADGALLSKHKVTGKFSWGAECKQYAVFAKAEAGVLGEFPAARLEVEWERLPIIVTTYAKKLG
KHILTAAYDTGFRFERATNSEKEIELTAALPSQRSLNIIARIPEITMSKRDIYLPVAVPINPDGTF SIETYEDFL
AWIQYIKEE-

H) vtg3-KO

LvH3 LvL3

5' MANYEPF **IVTRIVDIT** TQDL D 3'



Frame 1 5'>3'

|MANYEPFLNSKKTYEYKYEGLVQV GRELPHLVESALKLRCTFKI IGESPHTFVLQVSNVDFEDFN GIP **GKSVFS**
PSKNITKHL SAEISQPI IFEYSKGQITDIRTAPGVSN TVVNIVRGILGFLQVTVKTTQSFYELIELGIHGLCQSS
YTVD **EDSNAKELIVTRIVDITNCQQPASLYRGMALAPEDKLSKQGESV VSTVKHTYTVKSTADGGQITKAF AQE**
RQYFSPFNKGGNF <238aa> LKTLKFLPGYSNGAEKLS TRVQGA AVQAFRL LASRASHVQDIVLNL FVQKHL
PAEIRMLACIVLLETK P STALISV VSEV LLEADLQVASF SYSLKGF AKSRTPDNQHLSIACNIAMKILTRKLG
HLSYRYSKNLHFDWFDHDFLFGTSADVMLQNESPIPTKMLKGFHF IGRILQFLEFGIRADGLKDLFAGKIPE
LTKDLGISDLASILKILSNWQSLPKDKPLL TAYARVFGQEAFLMDVSRDSVQSI IKSFS PSAGKESKVWERIQDV
QKGT SWHTKPHLVYEARFIQPTCLGLPVEISKYSSVNAV TMKAKAEINPPPKEHLGELLSSDISM QTDGFIGV
TKDHFLFHGINTDLFQCGTELKSKVSMGLPWAFDLKINPKEQTYEMNLTPSKSVTELF SVSSNVYAVLRNIEDPT
SSKITPMPETGESWQVPLRMLPLRDEQTKKSGMKFRQCAEAKIYGTALCIEAEAKRAHYLHEYPLYLLGDT
HFSYSLEPAKDAKPIEKIQI QVSASRQHP S VMSGMVNLNRVFKETR DENTSCEERKTS SLPV | TQDL DVTPDP
VVTVKALSLSPOAKPLGYEGVAFYLP T **AOKDDIEMIVSEVGEANWKM CANAHFDKHTSAKAHLRWGAECQTYD**
VSMRVS AACQPESKPSISTKINWGTLP SVFTTVGQIQVQEYVPGVSYIMGFYQKKEENPERQASVIVVASSPETFD
LKVKIPERTIYKKKIPSPIELLGIEAANLTMST-

Rbd/Rbm
anti-zflvL3
epitope

Frame 2 5'>3'

WQIMSLF -TRKKHTS INMKDWYKWDGNCHTWLNQR -N -GALLKSLESHTPLSFRSQM -TLKILMAYLGKVSSAL
PKTSLSICLPRSASQSFNLKDKLLTFAQHLESQTQL -IL -GGSLDFYKSRSKPHKVFTN -LSWEF MCVRAVT
LLMKTLTQKS ---HELLISPTVNSQHLCTEVWLLHLKTNLANREAKALFPL -NTPTQ -SPQQT VVRLKHL LRSA
NISLRSM -REETS <238aa> SRLSSSSFLDTPMELKNFPPECRELQSKHLGCLQAEPP TVYRILS -TSSYRN IYQ
LKSACWPA -FF -RPSRQ L -FQ --VRSF -KRLICRLPVSP T L C SKALPSPVPLI INIYLLPVILP -RF -PVNLAT
-VTATARTCTLTGSM T FYLGHL LMFICFRMKVPSPQNLCLENFISLGEYCNFLSLSVQMDSKICLLEKSQNS
RKI -ESAIWLPY -KFSLTGRAYQKTSLF -QLMQEFLDRKPF -WM -AETQFKAS -SLSVLLQERRVKFGKGF KMR
KGLHGTGLSRILCMRLGYSRHVWVSQ LKSANIIP --MLLQ -KQK LK -ILLQRNIWVNC -AQTFPCRQMALSA -Q
RIIFSSMESTLIFFSVELS -KVRFWACRGHLT -K -IRKSKRMK -T -LQANRSPNYFQSVLMCMLF -ETLKTQPH
LK -HP -CLRQSGPRVCL -ECYPL -GMNRPKNLE -NSGNVLKPKFMELHSALRQKPNVHTIFTN ILCITYWVILT
FHTV -NQRMQNPLKFRFRSLPADN ILO --VEW -ISTKGYLRRQEMRTPPVRNAKHPVHSQ -LRI -MSLQTR -S
Q -KHLV -VHKQPLAMKA -PFICQLPKKTTL K -SSLKLVKKQTGKCVPMHILIRLIHQORLISDGVQSVKHMFL
-ECPQRANQSPNHL -AQRLTGGLCPQYSQQLVK -FKSMYLACLTLWVSTRKRRKTQNGRHLSSL -HPHQRP L T -K
-KFQSELSTKRKFPHQ LNFWGSKLQISPCQL

Frame 3 5'>3'

GKL -AFSELEKNIRV -I -RIGTSGTG TATPG -ISAETE VHF -NHWRVTHLCP SGLKCR L -RF -WHTWEKCLQPF
QKHH -ASVCRDQ PANHF -IF -RTNY -HSHSTWLSLKHSC EYCEGDPWIFTSHGQNHTKFLRTN -VGNSWVFSEQLH
C --RL -RKRVD SNTNC -YHQLSTASIFVQRYG SCT -RQT -QTERRKRCFHCE THLHSEVHSRRWSY -SICSGAP
IFLSVQCKGRKLP <238aa> QDSPQVPSWILQWS -KTFHQ SAGSCSPSI -AACKQSLPQCTGYCLKPLRTETFTS
-NPHAGLHSSSRDQAVHSSDFSSK -GPSRRG -SAGCQFLLSAQRLCQVPYP --STSIYCL -YCHEDSNP -TWPL
ELPLQEPAL -LVP --LFIWDIC -CLYASE -KSHPHKTYA -GKISFHWENTAIS -VWYPCRWTQRSVCWKNP RTH
ERFRNQRF GFHIENSL -LAEPTKRQASFDLSCKSFWTGS LFNCGCKQRLSSKHHKVQSF CRKGE -SLGKDSRCSE
RDFMALD -AASC V -GSVHTADMSGSPS -NQILFRSKCCYNESKS -NKSSSKGTSG -TAKLRHFHADRWL YRRDK
GSFSLPWNQH -SFSVWN -AEK -GFNGPAVGI -PENKSERANV -NELDSKQIGHRIIFS QF -CVCCFEKH -RPNLI
-NNTHDA -DRGVLGACASENVTPFKG -TDQKIWNEIQAMC -SQNLWNCTLH -GRSQTCTLSSRISSVLLTG -YSL
FIQFRTSKGCKTH -KNSDSGLCQQTTSFSNEWNGESQPKGI -GDKR -EHLL -GTQNIQFTPSNSGSRCHSRPGSH
SKST -FKSTSKTPWL -RRSLLSANC PKRRH -NDRL -SW -RSKLENVCQCTF --DSYISKSSQMGC RVSNI -CFY
ESVRSVPTRVQTIYKHKD -LGDSALS IHNSWSNSSRVCTWRV LHYGFLPEKGGKPRTAGICHRC SILTRDL -PES
ENSRANYLQENSLTN -TFGDRSCKSHHVNL

S1 Fig. Location and character of mutations introduced by CRISPR/Cas9 in zebrafish *vtgs*. A-B)

Location on genomic DNA. Schematic representations of the intron/exon structure of zebrafish *vtg1* (representative of type-I *vtgs*) and *vtg3* are given at the top of panels A and B, respectively. Horizontal line segments indicate introns and filled gold boxes indicate exons. Exons bearing CRISPR/Cas9 target sequences are indicated by large blue arrowheads pointing upwards to the target name (sg11, sg12, and sg13 for *vtg1*; sg31, sg32, and sg33 for *vtg3*). Horizontal dashed lines bearing dual arrowheads indicate regions where mutations were introduced, with the size of deletions in bp given below the arrows (1281 bp and 1181 bp for *vtg1*-KO and *vtg3*-KO, respectively). The lower sections of panels A and B show Clustal Omega alignments for partial genomic sequences of the *vtg1* and *vtg3* genes, respectively, covering regions where Cas9 introduced targeted mutations. Sequences of undisturbed wild type alleles are labeled *vtg1*^{+/+} and *vtg3*^{+/+}, and sequences of homozygous mutated alleles are labeled *vtg1*^{-/-} and *vtg3*^{-/-}, respectively. Dashes were introduced to illustrate regions where deletions occurred in the *vtg1*^{-/-} and *vtg3*^{-/-}-sequences. Nucleotide positions are indicated by numbers on the right and asterisks indicate nucleotide identity. Target sequences are enclosed in blue-shaded boxes emphasized by blue arrowheads on the right. Intron sequences are given in dark gray font enclosed in light gray filled frames and are labeled by Intron on the right with the same formatting. Exons are shown in regular black font and labeled on the right with exon numbers (e.g. Exon 6, 7, 8...). Exons bearing the target sites are also labeled with the target name below in parenthesis (e.g. Exon 14 (sg12)). **C-D**) Location on mRNA. The deleted region of mRNA is indicated in the sequence by magenta text showing the number of deleted nucleotides (703 bp *vtg1* and 714 bp for *vtg3*) enclosed by magenta angle brackets; flanking nucleotides that come together to form a new codon are underlined in magenta. **E-F**) Location on predicted cDNA. Nucleotide sequences targeted by sgRNAs for Cas9 editing and present in the predicted transcript are framed in blue-shaded boxes. The deleted region of the transcript is indicated in the sequence by magenta text showing the number of deleted nucleotides enclosed by magenta angle brackets, with flanking nucleotides that come together to form a new codon underlined in magenta (see also **S2 Fig**). The sequence encoding the Vtg receptor-binding domain (**RbD**) on the LvH of the respective Vtg (see **G-H**, below) is shown in italic typeface with the sequence encoding its critical, short receptor-binding motif (**RbM**) being additionally underlined. **G-H**) Location on predicted polypeptide sequence. Yolk protein domain models of Vtg1 (representative of zebrafish type-I Vtgs) or Vtg3 are pictured in 5' > 3' orientation above each panel. Contiguous white horizontal bars represent lipovitellin heavy and light chain (LvH, LvL) and

phosvitin (Pv) domains of the respective Vtg (Vtg3 lacks a Pv domain) that are labeled with their abbreviation above in large bold type. Sequences within these bars set in normal type represent the N-terminus of each yolk protein domain, the starting points of which are indicated, when present, by vertical bars in the predicted polypeptide sequences shown below. Predicted sequences arising from three frames of 5' > 3' translation performed using the Expasy translate tool (available online at <https://web.expasy.org/translate/>) are shown. Predicted products of open reading frames are highlighted in light gray, start codon products (methionine, **M**) are shown in bold green type, and stop codons are indicated by red dashed lines (-). The locations of deletions are indicated by magenta text showing the number of deleted amino acids (aa) enclosed by angle brackets. Residues encoded by nucleotide sequences targeted by sgRNAs for Cas9 editing are framed in blue-shaded boxes. Short sequences that were employed as epitopes to develop Vtg domain-specific antibodies against zebrafish (zf) Vtg1-LvH (anti-zfLvH1) and Vtg3-LvL (anti-zfLvL3) are indicated by boxed text in the respective LvH and LvL sequences, with their location also highlighted by black arrows labeled with the epitope names given by vertically-oriented text in the panel margins. The 85-residue Vtg receptor-binding domain (**RbD**) and the critical 8-residue Vtg receptor-binding motif (**RbM**) located within this domain, which were identified by Li et al. (2003) in the LvH domain of blue tilapia (*Oreochromis aureus*) VtgAb, are shown in the polypeptide sequences in boldface italic type, with the **RbM** sequence being additionally underlined and also shown in the yolk protein domain map above. The location of these sequences is also highlighted by black arrows labeled with **RbD/RbM** as vertically-oriented text in the panel margins. For *vtg1*-KO (panel G), the diagram below the yolk protein domain model shows the relative location of the 234 aa deletion introduced by CRISPR/Cas9 (double headed magenta arrow), the 529 aa sequence product of the contiguous open reading frame 1 (right pointing black arrow), which is terminated by a premature stop codon arising from a frameshift introduced by the deletion (see **Fig 2A**), and the 609 aa sequence product of the contiguous open reading frame 3 (right pointing blue arrow), which initiates just after the deletion. For *vtg3*-KO (panel H), the diagram below the yolk protein domain model employs the same symbols and color coding and shows the relative position of the in-frame 238 aa deletion introduced by CRISPR/Cas9 (see **Fig 2B**), and the remaining 999 aa sequence product of the contiguous open reading frame 1.

S1 Table. Targets, primers and probes utilized in *vtg1*-KO and *vtg3*-KO studies. Target oligo and screening primer names are given according Figure 1. CRISPR recognition NGG motifs are highlighted by bold typeface on sequences. Position of primers, target sites and probes on vitellogenin (Vtg) yolk protein (YP) domains are given on the far right columns.

Target Oligos	Sequence	Vtg YP domain
sg11_Rv	GGT TGAGCTGAAGGATGTTG	LvH
sg12_Rv	GGC AGCATCATTGATCATAT	LvH
sg13_Fw	GG AGGCTCTTAAAGCTTTC	LvH
sg31_Rv	GGG CTGAAGACACTTTTCCC	LvH
sg32_Fw	GGG AGGAAACTCCGAATGT	LvH
sg33_Fw	GGT CCTGCGCTGAAGTCTC	LvH
Screening Primers	Sequence	Vtg YP domain
11_Fw	GAAGCAACACTTAATAAGCAATGG	LvH
11_Rv	CTTATTACCTCTGTGCATTACAGC	LvH
12_Fw	CTTATGAGCCGCAAACCTGGA	LvH
12_Rv	TGTGAGTATCAGTCACAGTTCAA	LvH
13_Fw	AACTGGAGGAATCCATGAAGC	LvH
13_Rv	AGGTGTAATGGTGGCCCTGAA	LvH
31_Fw	TATGAAGGATTGGTACAAGTGGG	LvH
31_Rv	AGGATCCCCCTCACAAATATTC	LvH
32_Fw	TGATGAAGACTCTAACGCAAAAAGA	LvH
32_Rv	TTATACATCAGGTTGCCCTCTGC	LvH
33_Fw	AGTAAATCCCATCCTCTCCTGTG	LvH
33_Rv	TTAGTGCGCAACCAGATGAA	LvH
qPCR Primers (SybrGreen)	Sequence	Vtg YP domain
vtg1_Fw	GATTAAGCGTACACTGAGACCA	LvH
vtg1_Rv	AGCCACTTCTGTCCAAATACT	
vtg2_Fw	TGCCGCATGAAACTTGAATCT	Ct
vtg2_Rv	GTTCTTACTGGTGCACAGCC	
vtg3_Fw	GGGAAAGGATTCAAGATGTTTCAGA	LvH
vtg3_Rv	ATTTGCTGATTTCAACTGGGAGAC	
vtg4_Fw	TCCAGACGGTACTTTCACCA	LvL
vtg4_Rv	CTGACAGTTCTGCATCAACACA	
vtg5_Fw	ATTGCCAAGAAAGAGCCCAA	LvH
vtg5_Rv	TTCAGCCTCAAACAGCACAA	
vtg6_Fw	TTGGTGTGAGAACTGGAGG	LvH
vtg6_Rv	CCAGTTTGTGAGTGCCTTCAG	
vtg7_Fw	TTGGTGTGAGAACTGGAGGA	LvH
vtg7_Rv	TTGCAAGTGCCTTCAGTGTA	
rpl13a_Fw	TCTGGAGGACTGTAAGAGGTATGC	N/A
rpl13a_Rv	AGACGCACAATCTTGAGAGCAG	
eif1a_Fw	CTGGAGGCCAGCTCAAACAT	N/A
eif1a_Rv	ATCAAGAAGAGTAGTACCGCTAGCATTAC	
18S_Fw	TCGCTAGTTGGCATCGTTTATG	N/A
18S_Rv	CGGAGGTTCGAAGACGATCA	
qPCR Primers and probes (TaqMan)	Sequence	Vtg YP domain
vtg1_Fw	CCATGAAGCTCTCCTAAAATCTC	LvH
vtg1_probe	[FAM]CACTGAGAGCAGTCACAAACTGGAAGG[BHQ1]	
vtg1_Rv	TAGGCTGATGCTAGTGGTTTATC	
vtg2_Fw	GGCTGATGGTTTGTCACTTTATG	Ct
vtg2_probe	[FAM]TTGCCAATGGTACTGGAAGATCCAAG[BHQ1]	
vtg2_Rv	TGTCCCTTCATCCAGTCTGC	
vtg3_Fw	GCGTGTCTTACATTATGGGTTTC	LvL
vtg3_probe	[FAM]CGGCAGGCATCTGTATCGTTGTAG[BHQ1]	
vtg3_Rv	TCACTTTCAGGTCAAAGGTCTC	
vtg4_Fw	TAGCTGGTGAATTTACAACCTCCC	LvH
vtg4_probe	[FAM]CTCTGCAAAGGGTTCTGTCTGATCTTG[BHQ1]	
vtg4_Rv	GCATGGCAACTTCACGCAGA	
vtg5_Fw	AGGAACATTGCCAAGAAAGAGC	LvH
vtg5_probe	[FAM]AGGCTGAACCCTCAGTGGCTCTCAT[BHQ1]	
vtg5_Rv	GTCTCAATGTCCAGCAAG	
vtg6_Fw	GCCAAAAATTGTCAACCCTATG	LvL
vtg6_probe	[FAM]CTTAATGCAGCTTATGACACAGGATTCAGG[BHQ1]	
vtg6_Rv	TGACGGGGAGGTAAATATCCC	
vtg7_Fw	TATTCAGACTCTCGTGGTTGCTTT	LvH
vtg7_probe	[FAM]CAACGCATGAGAAGTTCAACCAATCC[BHQ1]	
vtg7_Rv	GGTAATCTCGTGGATGGGCT	

A) *vtg1*-KO

		516												
		V	D	A	I	L	A	L						
Wild type	gtt	gat	gcc	atc	ttg	gcc	ctg			
Mutant	gtt	gat	gcc	ata	tgg	cta	ctg			
		V	D	A	I	W	L	L						
		516												

-703 bp

B) *vtg3*-KO

		236												
		G	N	F	R	M	L	A						
Wild type	gga	aac	ttc	cga	atg	ttg	gca			
Mutant	gga	aac	ttc	ctc	aag	act	ctc			
		G	N	F	L	K	T	L						
		236												

-714 bp

S2 Fig. Location and consequence of deletion mutations introduced by CRISPR/Cas9 into zebrafish *vtgs*. **A) *vtg1*-KO.** The 703 bp deletion introduces a frame shift at residue 519, changing the codon without altering the encoded amino acid (isoleucine, I). This frame shift results in the appearance of a premature stop codon after 10 additional residues (not shown, see **Fig 2A** for details). **B) *vtg3*-KO.** The 714 bp deletion alters the codon encoding residue 239, resulting in the substitution of leucine (L) for arginine (R) at this position, but it does not otherwise alter the remainder of the Vtg3 polypeptide (see **Fig 2B**).