



HAL
open science

New millimeter wave generation scheme for MIMO-OFDM based Radio-over-Fiber system

M. El Yahyaoui, A. El Moussati, Ghaïs El Zein, Kamel Haddadi

► To cite this version:

M. El Yahyaoui, A. El Moussati, Ghaïs El Zein, Kamel Haddadi. New millimeter wave generation scheme for MIMO-OFDM based Radio-over-Fiber system. *Optics Communications*, 2019, 442, pp.101-105. 10.1016/j.optcom.2019.03.017 . hal-02089125

HAL Id: hal-02089125

<https://univ-rennes.hal.science/hal-02089125v1>

Submitted on 11 Apr 2019

HAL is a multi-disciplinary open access archive for the deposit and dissemination of scientific research documents, whether they are published or not. The documents may come from teaching and research institutions in France or abroad, or from public or private research centers.

L'archive ouverte pluridisciplinaire **HAL**, est destinée au dépôt et à la diffusion de documents scientifiques de niveau recherche, publiés ou non, émanant des établissements d'enseignement et de recherche français ou étrangers, des laboratoires publics ou privés.

New millimeter wave generation scheme for MIMO-OFDM based Radio-over-Fiber system

Moussa El Yahyaoui^a, Ali El Moussati^a, Ghais El Zein^b, Yamel Haddadi^c

^a*Department of Electronics, Informatics and Telecommunications, E. ISAO, University Mohammed Premier, Oujda, Morocco*

^b*Institute of Electronics and Telecommunications of Rennes, France.*

^c*University Lille, CNRS, UMR 8520 - IEMN, F-59000 Lille, France.*

Abstract

This paper proposes a new scheme for the generation and transmission of a MIMO-OFDM signal over optical fiber using a single local oscillator (LO) at 15GHz. This technique is based on subcarrier multiplexing and Optical Carrier Suppression (OCS) modulation using both Dual-Parallel Mach-Zehnder Modulator (DP-MZM) and Dual-Drive Mach-Zehnder Modulator (DD-MZM). DP-MZM is used to multiplex the MIMO-OFDM signals while DD-MZM is used to generate the 90GHz signal by quadrupling. The realistic and global simulation of the complete system is performed to predict the behavior of a Radio over Fiber (RoF) system prior to its realization. The optical and wireless channels are based on Single Mode Fiber (SMF) and Triple-S-and-Valley (TSV) models, respectively. We have exploited the allocated 7GHz in the 60GHz band for unlicensed use and we have successfully achieved 5km SMF followed by 3m wireless link at 70Gb/s. In comparison with traditional methods, the technique proposed combines better performance at relatively low-cost.

Keywords: 60GHz, MIMO, OFDM, Radio over Fiber, MMW generation.

1. Introduction

Over the last decade, there has been a lot of interest to achieve the highest data throughput. In this context, Multiple-Input Multiple-Output (MIMO) technology has proven its ability to improve data rate. However, the implementation of MIMO technology has been usually restricted to the microwave range ($< 30GHz$) resulting in limited data rate below few Gb/s. Therefore,

the transition to higher frequency range, specifically the 60GHz band, is considered by standardization organizations as a viable alternative to respond to the need of high data rate. In particular, new standards foreseen in this frequency range are capable of delivering data rate up to 70Gb/s (802.11.ad and 802.15.3c) [1]. However, the signals transmitted in this band suffer from a strong attenuation related to free-space propagation losses and multiple reflections due to the possible presence of obstacles. Thus, the radio coverage is generally limited to a few meters in the indoor environment. To extend this coverage to an entire building or a large area, Radio over Fiber (RoF) technology is considered.

Radio over Fiber has been widely described in the literature as a viable solution for transporting MIMO signals. Indeed, RoF allows the transport of multiple RF signals over single optical fiber from central office to base station. Various techniques have been described to transport MIMO signals over fiber [2–7]. Among them, we find the polarization-division-multiplexing (PDM) [2, 3], optical subcarriers multiplexing [4–6], or PDM with optical heterodyne up-converter at base station [7]. However, these techniques use more than one high-frequency local oscillator (up to 40GHz). In this work, we introduce a new technique that makes use of only one oscillator operating at 15GHz. In addition, this technique offers better performances compared to those used in [5] and [6].

The MIMO channel model used in this work is based on TSV model [8]. This model was proposed by the National Institute of Information and Communication Technology (NICT) - Japan to the 802.15.3c Channel model subgroup. TSV is a statistical model whose basic assumption is that multipath components arrive in clusters in both the temporal and spatial domains [9]. This model incorporates some of the antenna parameters within the channel accounting for their effects. We have used the model of Desktop environment which is a typical office desktop and computer cluster [10]. Compared to previous works [5, 3] and considering in this paper a more precise channel model, we propose in this work a global architecture including a hybrid system in the optical and wireless regimes for communications around 60 GHz. The behavior prediction of such system is carried out by a global simulation using the real characteristics of the functions: baseband, optical/RF and transmission environment. To validate our approach, we have evaluated and compared our technique that uses one LO with the method based on two LOs, in function of bit error rate (BER) performance and optical power spectrum.

The rest of this paper is organized as follows: Section 2 presents the 2×2 MIMO-RoF proposed system. Section 3 describes its theoretical analysis. Next, Section 4 presents the results obtained by simulation. Finally, some concluding remarks are given in Section 5.

2. Principle of the proposed system

The proposed 2×2 MIMO-RoF architecture is presented in Fig. 1. The OFDM complex baseband signals, $I_j - OFDM$ and $Q_j - OFDM$ (with $j=1,2$), were generated using Matlab/Simulink and then sampled at 10 GS/s. These signals are obtained by mapping binary data into QPSK, 16QAM, or 64QAM. The mapped data is coded using a Vertical-Bell Laboratories Layered Space-Time (V-BLAST) coder, which corresponds to spatial multiplexing technique, to form two OFDM signals. Two training sequences are inserted before the Inverse Fast Fourier Transform (IFFT) operation for channel estimation at receiver. The OFDM signal is obtained by using FFT of 512 points with a cyclic prefix (CP) of 1/8 symbol time, and 355 subcarriers which corresponds to 6.93GHz bandwidth. The principle of the used RoF downlink, with an optical carrier (f_c) transmitting two RF OFDM (RF_1 and RF_2) signals, is based on dual parallel MZM (DP-MZM) and dual drive MZM (DD-MZM). The OFDM baseband signals are up-converted electrically to $f_{LO} = 15\text{GHz}$ using I/Q mixers. The converted signals are coupled through a 90° hybrid coupler. The DP-MZM is polarized to its minimum transmission bias point to realize optical carrier suppression (OCS) modulation and the used parameters are shown in Table 1. This MZM is driven by the combined signals to modulate the optical carrier and to multiplex the subcarriers as depicted in inset (b) [6, 11].

In order to generate 60GHz ($4 \times f_{LO}$) from optical heterodyne in photo-detector, a DD-MZM is used to generate two subcarriers, spaced by 90GHz (inset d'), to be combined with the multiplexed RF-OFDM subcarriers (inset c) [12]. The multiplexed subcarriers, depicted in inset (e), are transported from central station to base station through a single mode optical fiber. The received optical signal at base station is interleaved to separate the two RF-OFDM components of 2×2 MIMO signal. Finally, the interleaved signals are converted in the electrical domain using two photodiodes. An interleaver is used after DD-MZM to delete the unused subcarriers of frequency $f_c + f_{LO}$ and $f_c - f_{LO}$ (an optical filter can be used).

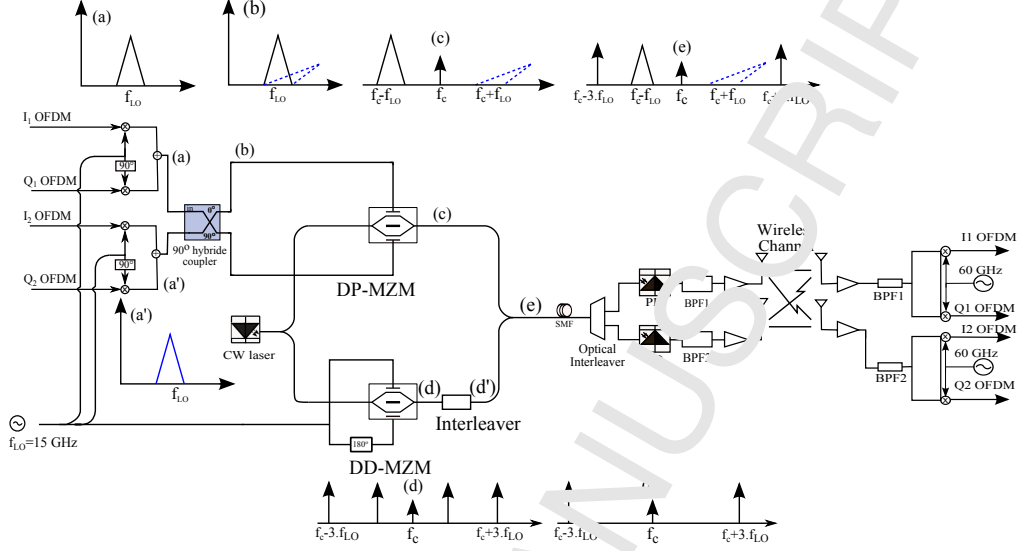

Figure 1: Schematic principle of the proposed system

Parameter	Value
Extinction ratio	30 dB
Switching bias voltage	4V
Switching RF voltage	4V
Bias voltage 1	0V
Bias voltage 2	4V

Table 1: Parameters of DP-MZM modulator

3. Theoretical analysis

The signal generated from the DD-MZM, inset (d) of Fig. 1, has the optical field $E_{out}(t)$ defined as

$$E_{out}(t) = E_i(t) \exp [j\beta \cos(\omega_m t + \varphi)] + \exp [j\beta \cos \omega_m t + j\phi_0] \quad (1)$$

where $E_i(t) = E_c \exp(j\omega_c t)$ is the optical carrier, $j^2 = -1$, E_c represents the amplitude, ω_c is the angular frequency of the optical carrier ($\omega_c = 2\pi f_c$), β is the modulation index of the DD-MZM, $\Delta\varphi$ is the phase difference of RF signal applied to two arms of DD-MZM, ϕ_0 is the phase obtained by adjusting the DC bias of DD-MZM, ω_m is the angular frequency for the RF

signal. From Jacobi-Anger expansion [12], Eq. (1) has the form

$$E_{out}(t) = E_c \sum_{n=-\infty}^{+\infty} j^n J_n(\beta) \exp [j(\omega_c + n\omega_m)t] \exp (jn\Delta\phi) + \exp (j\phi_0) \quad (2)$$

where $J_n(\beta)$ is the n th Bessel function of the first kind.

Since the sidebands of order 3^{rd} , 2^{nd} , 1^{st} , 0^{th} , $+1^{st}$, $+2^{nd}$, and $+3^{rd}$ are of the most importance for our modulation, we list the optical fields of these sidebands as follows:

$$\begin{aligned} E_{-3} &= E_c \exp(j\frac{3\pi}{2}) [J_3(\beta_1) \exp(-j3\varphi) + J_3(\beta_2) \exp(j\phi_0)] \exp [j(\omega_c t - 3\omega_e t)] \\ E_{-2} &= E_c \exp(j\pi) [J_2(\beta_1) \exp(-j2\varphi) + J_2(\beta_2) \exp(j\phi_0)] \exp [j(\omega_c t - 2\omega_e t)] \\ E_{-1} &= E_c \exp(j\frac{\pi}{2}) [J_1(\beta_1) \exp(-j\varphi) + J_1(\beta_2) \exp(j\phi_0)] \exp [j(\omega_c t - \omega_e t)] \\ E_0 &= E_c [J_0(\beta_1) + J_0(\beta_2) \exp(j\phi_0)] \exp(j\omega_c t) \\ E_{+1} &= E_c \exp(j\frac{\pi}{2}) [J_1(\beta_1) \exp(j\varphi) + J_1(\beta_2) \exp(j\phi_0)] \exp [j(\omega_c t - \omega_e t)] \\ E_{+2} &= E_c \exp(j\pi) [J_2(\beta_1) \exp(j2\varphi) + J_2(\beta_2) \exp(j\phi_0)] \exp [j(\omega_c t - 2\omega_e t)] \\ E_{+3} &= E_c \exp(j\frac{\pi}{2}) [J_3(\beta_1) \exp(j3\varphi) + J_3(\beta_2) \exp(j\phi_0)] \exp [j(\omega_c t - 3\omega_e t)] \end{aligned} \quad (3)$$

The corresponding optical powers are:

$$\begin{aligned} P_{-3} &= E_c^2 [J_3^2(\beta_1) + J_3^2(\beta_2) + 2J_3(\beta_1)J_3(\beta_2) \cos(3\varphi + \phi_0)] \\ P_{-2} &= E_c^2 [J_2^2(\beta_1) + J_2^2(\beta_2) + 2J_2(\beta_1)J_2(\beta_2) \cos(2\varphi + \phi_0)] \\ P_{-1} &= E_c^2 [J_1^2(\beta_1) + J_1^2(\beta_2) + 2J_1(\beta_1)J_1(\beta_2) \cos(\varphi + \phi_0)] \\ P_0 &= E_c^2 [J_0^2(\beta_1) + J_0^2(\beta_2) + 2J_0(\beta_1)J_0(\beta_2) \cos(\phi_0)] \\ P_{+1} &= E_c^2 [J_1^2(\beta_1) + J_1^2(\beta_2) + 2J_1(\beta_1)J_1(\beta_2) \cos(\varphi - \phi_0)] \\ P_{+2} &= E_c^2 [J_2^2(\beta_1) + J_2^2(\beta_2) + 2J_2(\beta_1)J_2(\beta_2) \cos(2\varphi - \phi_0)] \\ P_{+3} &= E_c^2 [J_3^2(\beta_1) + J_3^2(\beta_2) + 2J_3(\beta_1)J_3(\beta_2) \cos(3\varphi - \phi_0)] \end{aligned} \quad (4)$$

In order to obtain an OCS modulation with the even sidebands order suppressed (in our case 2^{nd} , 0^{th} , $+2^{nd}$ order sidebands), the following conditions should be verified

$$\begin{aligned}
\cos(\phi_0) &= -1 \\
\cos(2\varphi - \phi_0) &= -1 \\
\cos(2\varphi + \phi_0) &= -1 \\
\beta_1 &= \beta_2
\end{aligned} \tag{5}$$

From (5), we have $\beta_1 = \beta_2$, $\varphi = \pi(\text{mod}2\pi)$, and $\phi_0 = \pi(\text{mod}2\pi)$. Thus, the OCS modulation can be realized by means of a 180° hybrid coupler and a dual-drive MZM by a proper DC bias, which introduces an additional phase difference of π between the two arms of the dual-drive MZM.

4. Simulation results and discussion

The simulation of the proposed system is performed with a cosimulation technique using MATLAB/Simulink and OptiSystem. The simulation results are depicted in this section. We have started by fixing the optimal optical power injected in the optical modulators to avoid operation in the nonlinearity regime of optical components. Indeed, we have calculated the EVM performance at the receiver (Rx) for each value of optical power at the transmitter (Tx), as shown in Fig. 2. We have obtained 10dBm as optimal

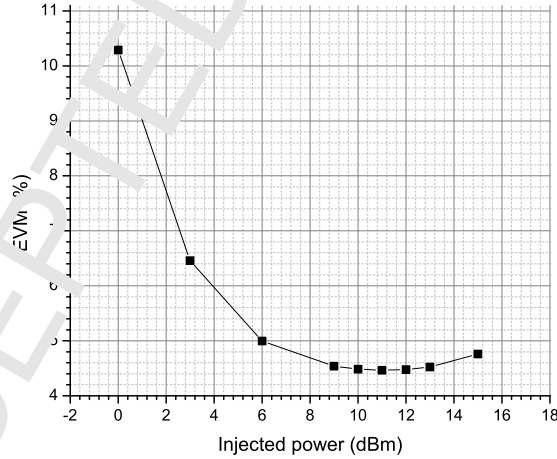

Figure 2: EVM variation in function of injected optical power

value, which corresponds to the minimum of EVM and optical power. The

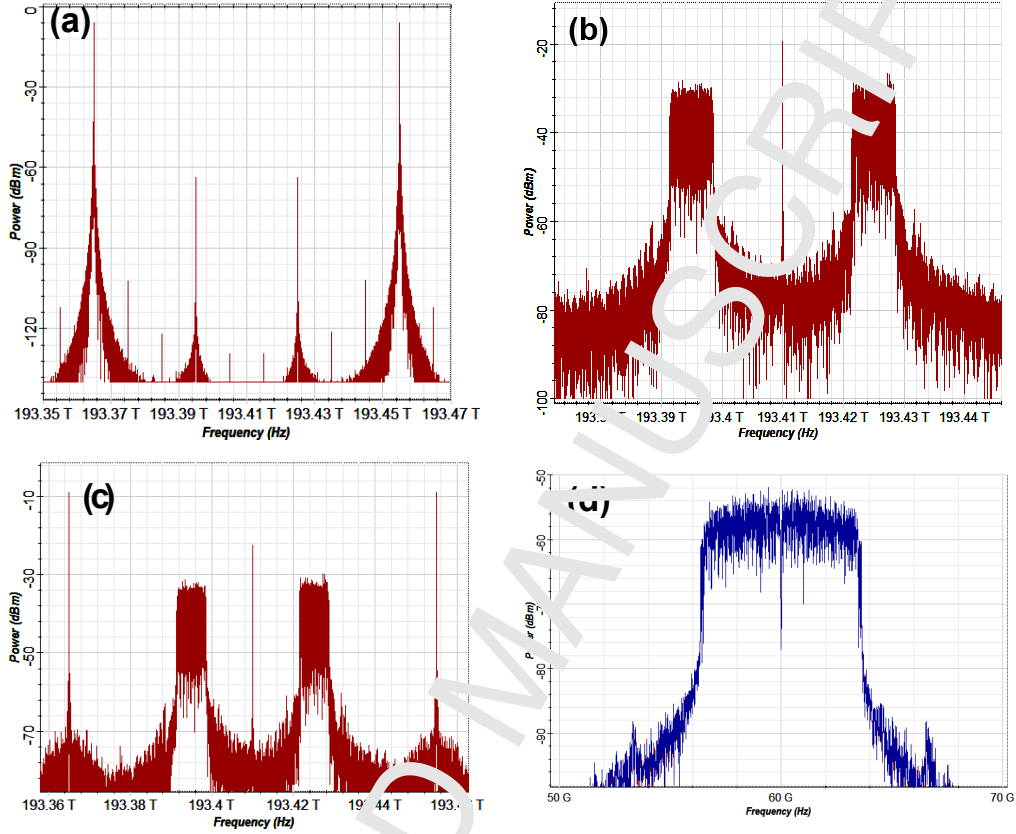

Figure 3: a) Generated subcarriers with 90GHz separation, b) Multiplexed subcarriers, c) Combined optical signal, d) Spectrum at reception (25km)

EVM is calculated for 50 μ m SMF with, high efficiency, 64QAM modulation scheme. Fig. 3 shows the optical spectrum of generated subcarriers with 90GHz separation (a), the multiplexed subcarriers of OFDM-MIMO signals (b), the combined optical signal (c) to be transported through optical fiber, and the frequency spectrum of millimeter wave at reception after photodetector.

For our simulations, the 2×2 MIMO channel is developed in our previous research [3], which is based on TSV model [10]. To create sufficient antenna decorrelation, the transmitting and receiving antennas were separated by 9 cm and 5 cm, respectively [6]. The considered radio link has 3m of distance between Tx and Rx. In Fig. 4, we show the variation of BER in function of optical fiber length at fixed signal-to-noise ratio E_b/N_0 of 7dB. From this

value, performance of 70Gb/s using a 64QAM modulation scheme is achieved over, up to, 42km of SMF length with a BER of 10^{-3} .

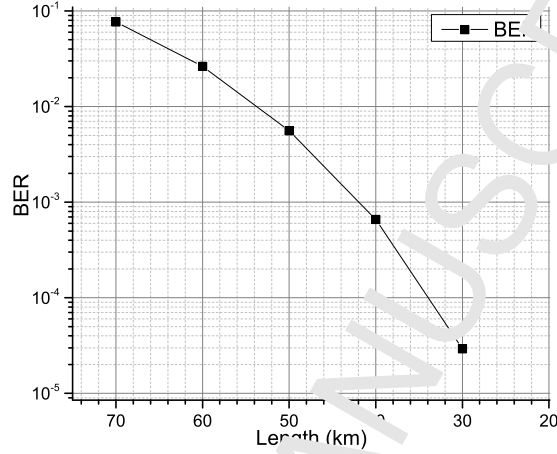

Figure 4: BER in function of SMF length for $E_b/N_o = 7\text{dB}$

Then, we have calculated the performance of the system for 50km SMF, using different modulation schemes. The modulations used are QPSK, 16QAM, and 64QAM, which correspond to bit rates of 23.32Gb/s, 46.66Gb/s, and 70Gb/s, respectively. These results are obtained without using channel coding. Fig. 5 shows the performance of 2×2 MIMO-RoF for different modulations. These results are obtained for 50km SMF followed by 3m wireless

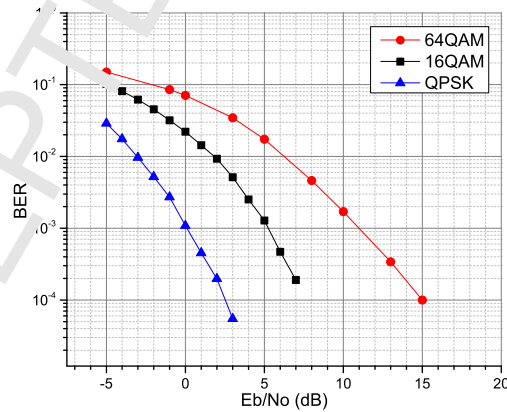

Figure 5: Variation of BER in function of modulation and E_b/N_o

channel.

For comparison purpose, we have also simulated a system based on two LO (25GHz and 35GHz) as in [5]. This comparison is made in the same conditions and with the same parameters in terms of modulation, data rate, and optical power. As we can see in Fig. 6, the optical spectrum obtained with the proposed system, using a single LO (15GHz) (in blue), shows low attenuation of the optical power. Indeed, a difference of 10 dB between the generated spectra is noticed.

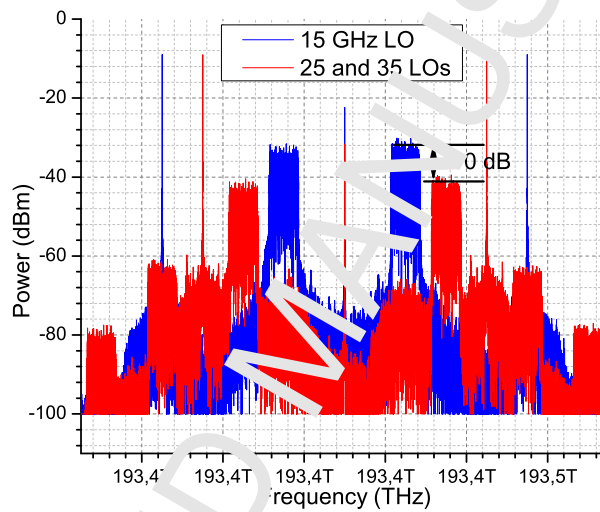

Figure 6: Optical spectra of the multiplexed subcarriers in both cases: with one LO (blue) and with two LOs (red)

We have also compared the transmission performance of a 2×2 MIMO system at 70Gb/s with SMF fiber of 25km, as shown in Fig. 7. This comparison is performed by using 64QAM, 16QAM, and QPSK modulation schemes, which allows us to see easily the difference between the performances of studied systems. As we can see, our system offers better BER performance. Indeed, considering $PER = 10^{-3}$, a gain of 10dB in term of E_b/N_0 is noticed. Moreover by comparing these results with those obtained experimentally in [5], where they have used two LOs, we concluded that our system has better performance. Indeed, the authors in [5] have transmitted 61.5Gb/s data rate signal with BER of 10^{-3} over 25km SMF transmission followed by 3m wireless transmission, while we have transmitted 70Gb/s over 50km SMF followed by a 3m wireless transmission.

5. Conclusion

This paper presents the design and simulation of a new 2×2 MIMO OFDM-RoF system architecture based on a single oscillator at 15GHz. In addition to the simplicity and relatively low-cost of the proposed solution, the results obtained demonstrate better performance compared to those obtained using an architecture based on two oscillators. In particular, the solution proposed can achieve data rate of 70Gb/s over 50km SMF followed by a 3m wireless transmission. This performance improvement is due to the gain provided in terms of optical power generated.

References

- [1] R. Bhusal, S. Moh, Qualitative and Quantitative Comparison of IEEE 802.15.3c and IEEE 802.11ad for Multi-Gbps Local Communications, *Wireless Pers Commun*, 75 (2014) 2135-2149.
- [2] M.A. Elmagzoub, A. Bakar Mohammad, R.Q. Shaddad, S.A. Al-Gailani, Polarization multiplexing of two MIMO RoF signals and one baseband signal over a single wavelength, *Optics & Laser Technology*, 76 (2016) 70-78.
- [3] H. Huang, C. Sun, C. Lin, C. Wei, W. Zeng, H. Chang, B. Shih, A. Ng'oma, Direct-Detection PDM-OFDM RoF System for 60-GHz 2×2 MIMO Wireless Transmission Without Polarization Tracking, *Journal of Lightwave Technology*, 36 (2018) 3739-3745.
- [4] C. Ho, W. Jiang, P. Sambaraju, W. Lee, T. Lu, C. Wang, H. Yang, C. Lin, C. Wei, S. Chi, A. Ngoma, Performance Evaluation of a 60 GHz Radio-over-Fiber System Employing MIMO and OFDM Modulation, *Ieee J Sel Area Comm*, 31 (2013) 780-787.
- [5] C.-H. Lin, C.-T. Lin, H.-T. Huang, W.-S. Zeng, S.-C. Chiang, H.-Y. Chang, 60-GHz optical/wireless MIMO system integrated with optical subcarrier multiplexing and 2×2 wireless communication, *Opt Express*, 23 (2015) 12111-12116.
- [6] M. El Yahyaoui, A. El Moussati, G. El Zein, On the capacity of MIMO-OFDM based diversity and spatial multiplexing in Radio-over-Fiber system, *Opt Commun*, 402 (2017) 252-259.

- [7] J. Yu, X. Li, N. Chi, Faster than fiber: over 100-Gb/s signal delivery in fiber wireless integration system, *Opt Express*, 21 (2013) 22885-22904.
- [8] Y. Shoji, H. Sawada, C.S. Choi, H. Ogawa, A Modified SV Model Suitable for Line-of-Sight Desktop Usage of Millimeter-Wave WPAN Systems, *IEEE Transactions on Antennas and Propagation* 57 (2009) 2940-2948.
- [9] S. Hirokazu, S. Yozo, C. Chang-Soon, Proposal of novel statistic channel model for millimeter wave WPAN, 2006 Asia Pacific Microwave Conference 2006, pp. 1855-1858.
- [10] SK. Yong, et al., TG3c Channel Modeling Sub-committee Final Report, IEEE802.15-07-0584-01-003c Mars 2017-2017.
- [11] Z. Zheng, M. Peng, H. Zhou, M. Chen, L. Jiang, L. Tan, X. Dai, Y. Xiang, Optical single sideband millimeter-wave signal generation and transmission using 120hybrid coupler, *Opt Commun*, 411 (2018) 21-26.
- [12] M. Xue, S. Pan, Y. Zhao, Optical Single-Sideband Modulation Based on a Dual-Drive MZM and a 120° Hybrid Coupler, *Journal of Lightwave Technology*, 32 (2014) 3317-3323.

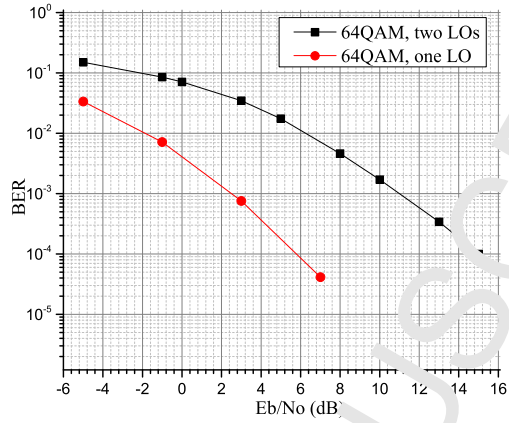

(a) BER comparison for 64QAM modulation

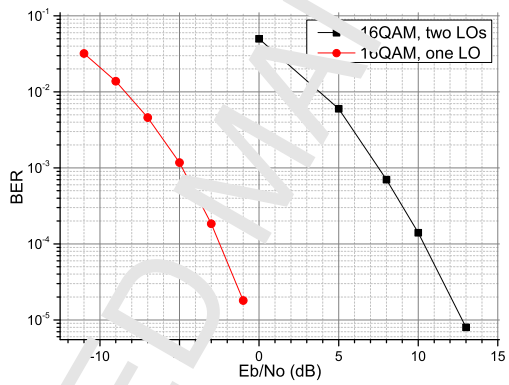

(b) BER comparison for 16QAM modulation

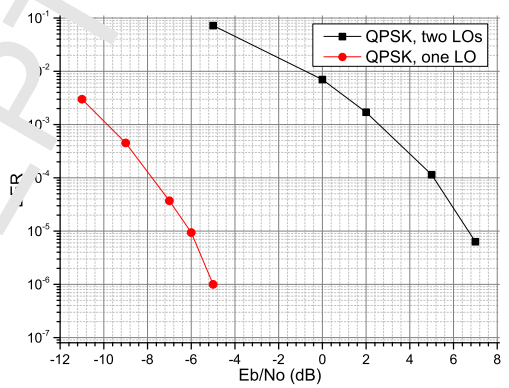

(c) BER comparison for QPSK modulation

Figure 7: BER comparison between using one LO and two LOs

- New scheme for 2x2 MIMO-OFDM RoF using a single local oscillator
- A realistic and global simulation of 2x2 MIMO-OFDM RoF system is proposed.
- Low-cost technique for Radio over Fiber system

ACCEPTED MANUSCRIPT