



**HAL**  
open science

# Electrically Reconfigurable Radiation Patterns of Slot Antenna Array Using Agile Plasma Wall

Oumar Alassane Barro, Mohamed Himdi, Alexis Martin

► **To cite this version:**

Oumar Alassane Barro, Mohamed Himdi, Alexis Martin. Electrically Reconfigurable Radiation Patterns of Slot Antenna Array Using Agile Plasma Wall. Progress In Electromagnetics Research M, 2017, 73, pp.75 - 80. hal-01775260

**HAL Id: hal-01775260**

**<https://univ-rennes.hal.science/hal-01775260>**

Submitted on 24 Apr 2018

**HAL** is a multi-disciplinary open access archive for the deposit and dissemination of scientific research documents, whether they are published or not. The documents may come from teaching and research institutions in France or abroad, or from public or private research centers.

L'archive ouverte pluridisciplinaire **HAL**, est destinée au dépôt et à la diffusion de documents scientifiques de niveau recherche, publiés ou non, émanant des établissements d'enseignement et de recherche français ou étrangers, des laboratoires publics ou privés.

# Electrically Reconfigurable Radiation Patterns of Slot Antenna Array Using Agile Plasma Wall

Oumar A. Barro<sup>\*</sup>, Mohammed Himdi, and Alexis Martin

**Abstract**—In this paper, an antenna with reconfigurable radiation pattern in the  $H$ -plane at 2.45 GHz for high power applications is presented. It is based on a 3-slot array in the  $E$ -plane covered partially with a wall of plasma in order to reduce the length of the slots and consequently ensure electrically a modification of the radiation pattern in the  $H$ -plane. The power distribution of the array is ensured with a power splitter.

## 1. INTRODUCTION

High Power Microwave (HPM) antennas are well suited for high pulsed power applications [1] such as non-lethal weapons or drones interception. In this field of applications, antennas must provide good efficiency and low back-side radiation together with a very good impedance matching. The radiation pattern control and especially Half Power Beamwidth (HPBW) reconfiguration are important for modifying the degree of focalization depending on scanning the area of interest. However, there is a challenge to maintain a suitable power handling with the reconfiguration of the radiation pattern.

Two particular ways are proposed to implement the reconfigurable radiation pattern with variable HPBW. The first one is based on electronic devices (PIN diodes, transistors and switches) to electronically control the radiation pattern [2, 3]. The other is to use a mechanical system as in [4] with a defocusing system on a parabolic antenna.

Recently in [5], the authors proposed a solution based on a coupled three-slot array. This solution is limited in term of choosing inter-element distance (typically  $0.75\lambda$ ). On the other hand, in [6], the solution allowing to choose any distance is achieved by using a three-way waveguide splitter. Also in this reference, the phase and magnitude can be easily fixed. Both solutions use the motion of metallic flaps in order to reconfigure the radiation patterns mechanically. These techniques take time in order to have all the configurations.

In this paper, an  $H$ -plane electrically actuated radiation pattern antenna is presented. The HPBW reconfiguration from  $17^\circ$  to  $66^\circ$  is provided by using an agile plasma wall.

## 2. ANTENNA DESIGN AND FABRICATION

The proposed antenna is based on a sectoral horn antenna radiating aperture with the illustrated uniform E-Field amplitude and phase distributions (Figure 1). The objective of the design is to change the physical aperture length in order to obtain the reconfigurable radiation pattern in the  $H$ -plane. According to [7], the mathematical relation between the physical aperture length and the corresponding

---

Received 12 January 2017, Accepted 28 March 2017, Scheduled 11 April 2017

\* Corresponding author: Oumar Alassane Barro (oumar-alassane.barro@univ-rennes1.fr).

The authors are with the Institute of Electronics and Telecommunications of Rennes, UMR CNRS 6164, University of Rennes 1, France.

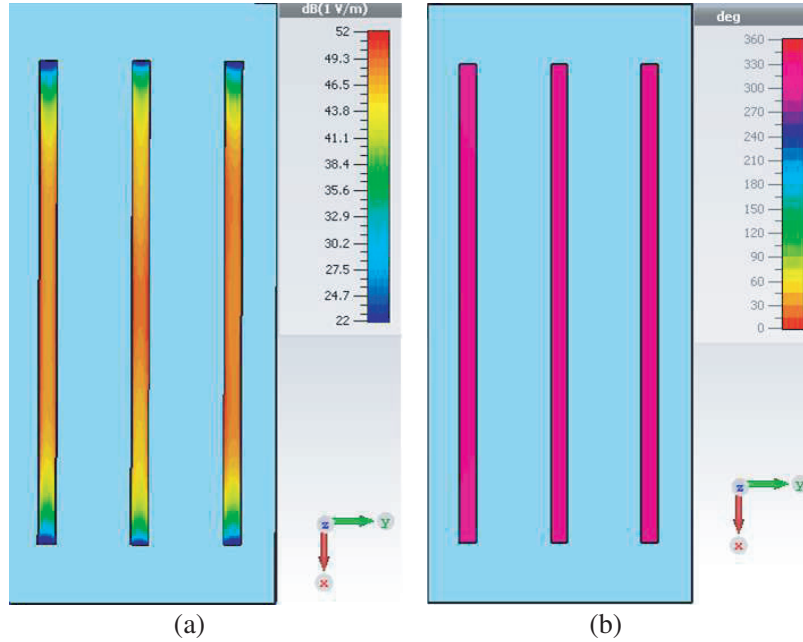

**Figure 1.** Electrical field distribution into the apertures. (a) Magnitude. (b) Phase.

HPBW ( $\theta_{H(-3\text{dB})}$  in degrees) can be expressed approximately as follows (for the uniform electric field distribution along the aperture):

$$\theta_{H(-3\text{dB})} = \lambda_0 \times 180 / (a\pi) \quad (1)$$

where  $\lambda_0$  is the wavelength in the free space and  $a$  the length of the aperture. In order to be compliant with a HPBW variation in the  $H$ -plane from  $20^\circ$  to  $60^\circ$ , it is deduced that at 2.45 GHz the antenna's aperture length should evolve from 351 mm to 117 mm. In this design, the length of the slot is fixed at 400 mm.

To provide constant amplitude and phase distributions along an aperture, an  $H$ -plane bended sectoral horn is used as a feeder. The length of the horn is fixed at 390 mm to guarantee the constant phase distribution. In order to keep the  $E$ -plane beamwidth at  $30^\circ$ , a three-slot array with inter-element distance equal to  $0.6\lambda$  at 2.45 GHz is used.

### 2.1. Existing Solution to Control Mechanically the HPBW in $H$ -Plane

In [6], the authors proposed a solution using metallic flaps (Figure 2) in order to control the length of radiating apertures.

To provide the amplitude and phase distributions to each aperture ( $E$ -plane), a power splitter in the  $E$ -plane is used after the horn. The global design is presented in Figure 2.

### 2.2. Proposed Solution to Control Electrically the HPBW in $H$ -Plane

In order to reconfigure the HPBW in the  $H$ -plane very quickly, it is better to propose an electronic control solution. The evident solution is to use PIN diodes or MEMS switches. Until now, it is difficult to find this kind of component accepting high power. Another problem is the compatibility between waveguide technology and electronics devices. The future development of GaN technology could resolve a part of those problems, but unfortunately not available today in the market.

In [8], a commercial spiral plasma lamp is used in order to control the radiation pattern of a single circular patch antenna. Also in [9], the authors used cylindrical commercial plasma lamps to reconfigure the HPBW of patches array. For both references, the plasma has a quasi-metallic behavior when it is energized (ON state) and transparent against electromagnetic waves when the plasma is de-energized (OFF state).

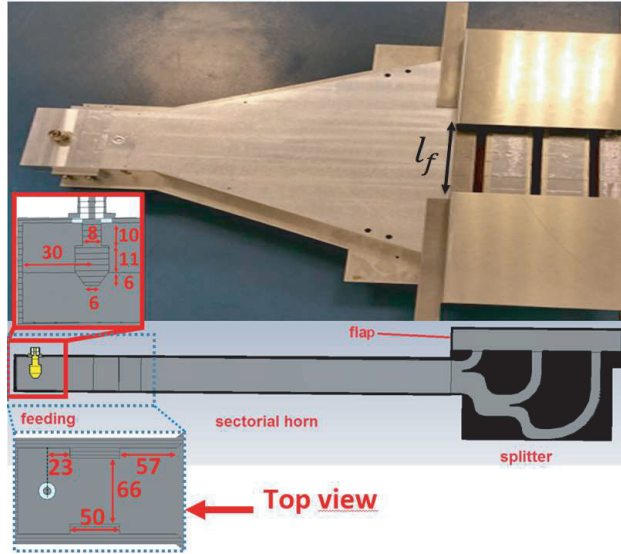

Figure 2. Global design of the antenna with metallic flaps.

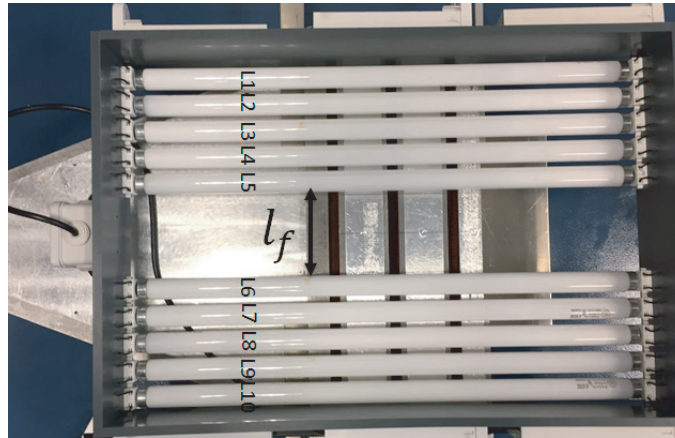

Figure 3. Global design of the antenna with agile plasma wall.

The same idea is proposed in the present paper as an electrical solution for high speed control of the HPBW of waveguide slot antenna array (Figure 3).

Plasma wall is built using florescent lamps (4000 K color temperature) which are arranged in parallel (see Figure 3). The first two lamps are placed at  $\pm 50$  mm from the center in order to have an aperture slot length  $l_f = 100$  mm. The distance between two adjacent lamps is 6 mm ( $\simeq \lambda/20$ ) due to the lamp socket bi-pin G13. The diameter and length of the lamp are 26 mm and 590 mm, respectively. The plasma wall is put above the radiating apertures at the same distance as the metallic flaps ( $h = \lambda_0/4$ ).

The lamps seen in Figure 3 are numerated L1 to L10. We evaluate the HPBW and maximum realized gain for 4 different  $l_f$  values ( $l_f = 100$  mm,  $l_f = 228$  mm,  $l_f = 292$  mm and  $l_f = 400$  mm). The studied configurations are shown in Table 1.

Table 1. Configuration for different values of  $l_f$ .

Length (mm)	$l_f = 100$	$l_f = 228$	$l_f = 292$	$l_f = 400$
Switching ON	all the lamps	L1, L2, L3, L8, L9 and L10	L1, L2, L9 and L10	-

### 3. RESULTS AND DISCUSSION

The simulations were performed using CST Microwave Studio [10]. The tube containing the gas is made from lossy pyrex glass with  $\epsilon_r = 4.82$ ,  $\tan \delta = 0.005$  and thickness of 0.5 mm. The plasma obeys the Drude model defined by two parameters: plasma angular frequency  $\omega_p$  and electron-neutral collision frequency  $\nu$ . The plasma parameters used in this study are  $\nu = 900$  MHz and  $\omega_p = 43.9823 \cdot 10^9$  rad/s [11].

Figure 4 shows the  $S_{11}$  magnitude comparison between the metallic flaps presented in [6] and plasma flaps. There is a small frequency shift of 10 MHz between simulation and measurement. In the metallic flaps case, the antenna is matched ( $S_{11} < -10$  dB) for  $l_f$  between 400 mm (no flaps over the apertures) and 200 mm. The magnitude of  $S_{11}$  for  $l_f = 100$  mm is  $-5$  dB in simulation and  $-7$  dB in measurement. On the other hand, in plasma wall case, the antenna is well matched for all  $l_f$  lengths (from 400 mm to 100 mm) in measurement and simulation contrary to the metallic flaps case probably due to the conductivity of plasma. In fact, the plasma is considered as lossy metal.

Radiation patterns have been measured in order to validate the simulation results. Measurements have been performed in an SATIMO anechoic chamber (near fields setup) with a peak gain accuracy equals to  $\pm 0.8$  dBi. The simulated radiation patterns are presented at 2.45 GHz, and the measured radiation patterns are given at 2.44 GHz in agreement with the best matching frequency.

Figures 5 and 6 show respectively the  $H$ -plane and  $E$ -plane for the simulated and measured normalized radiation patterns and for different values of  $l_f$ . The simulated and measured results are in

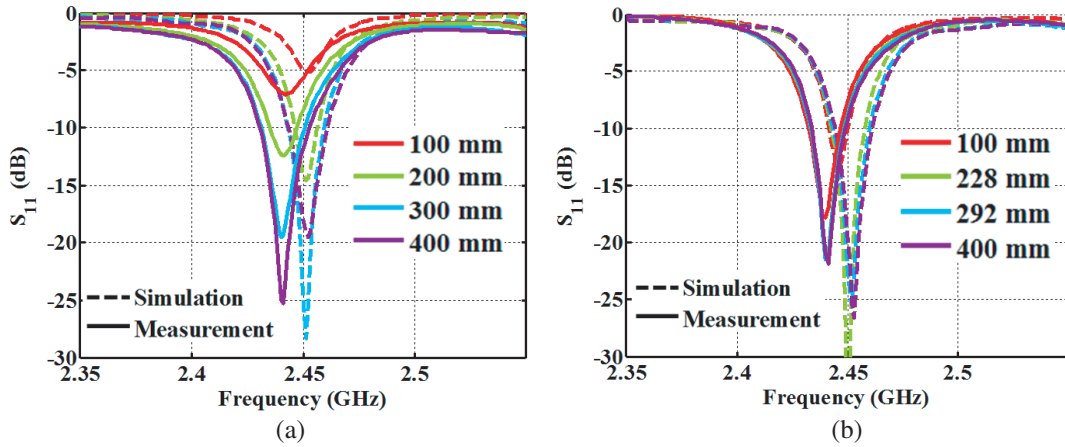

**Figure 4.**  $S_{11}$  magnitude comparison. (a) Metallic flaps [6]. (b) Plasma wall.

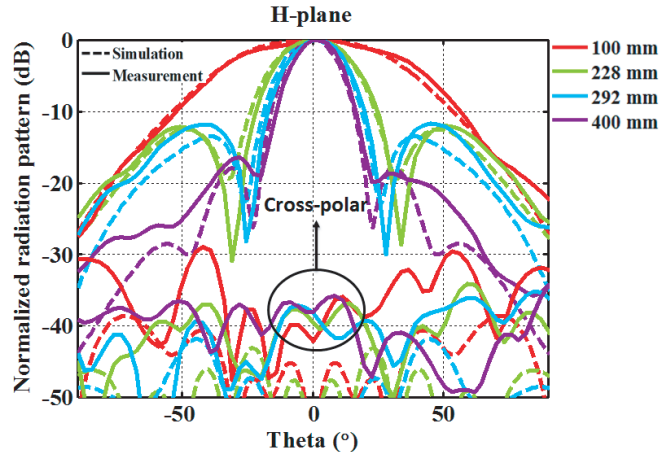

**Figure 5.** Normalized  $H$ -plane radiation patterns with the plasma wall.

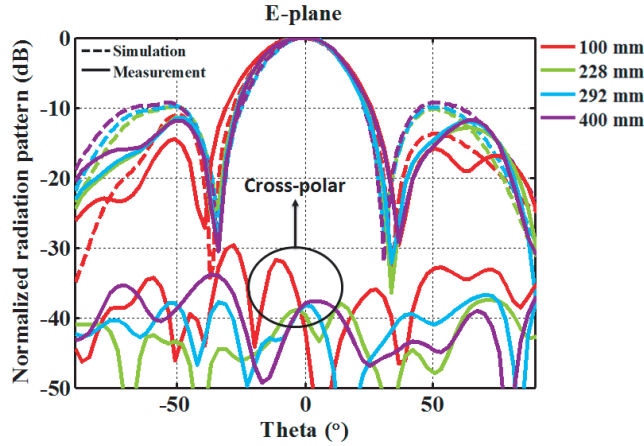

Figure 6. Normalized  $E$ -plane radiation patterns with the plasma wall.

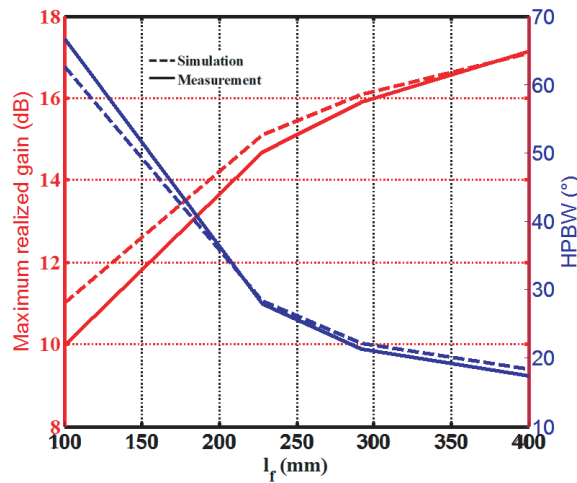

Figure 7. Gain and HPBW versus  $l_f$  with the plasma wall.

good agreement. In the  $E$ -plane, the radiation patterns are not changed whatever the value of  $l_f$  with a HPBW of almost of  $30^\circ$  and the side-lobe levels lower than  $-10$  dB. In the  $H$ -plane, the HPBW varies from  $62.6^\circ$  ( $l_f = 100$  mm) to  $18^\circ$  ( $l_f = 400$  mm) in simulation and from  $66.7^\circ$  ( $l_f = 100$  mm) to  $17.3^\circ$  ( $l_f = 400$  mm) in measurement.

Figure 7 presents the HPBW and maximum realized gain versus  $l_f$ . The maximum realized gain varies between 11 dB and 17.1 dB in simulation and from 9.9 dB to 17.1 dB in measurement. This difference is due to the losses which are not well estimated for commercial lamp. The worst case is observed when 10 lamps are used ( $l_f = 100$  mm), and the gap is reduced when fewer lamps are used.

#### 4. CONCLUSION

A high power pattern reconfigurable antenna has been designed with a sectoral horn antenna and an  $E$ -plane waveguide splitter. Plasma wall is used to reconfigure the HPBW in the  $H$ -plane electrically. The HPBW radiation pattern is fixed in the  $E$ -plane ( $30^\circ$ ) and changes in the  $H$ -plane from  $17^\circ$  ( $l_f = 400$  mm) to  $66^\circ$  ( $l_f = 100$  mm). The results in terms of HPBW and gain are similar for the metallic flaps and agile plasma wall, but in term of  $S_{11}$  the results obtained for plasma wall are better than for metallic flaps due to the additional losses in plasma tubes. Furthermore, the advantage of using plasma wall instead of metallic flaps is the speed of the radiation pattern control.

## ACKNOWLEDGMENT

The authors are very grateful to Laurent Cronier, Christophe Guitton and Xavier Morvan for the fabrication of the prototype and Jérôme Sol for the help with measurements.

## REFERENCES

1. Li, X., Q. Liu, and J. Zhang, "Design and application of high-power cavity-backed helical antenna with unit ceramic radome," *Electronics Letters*, Vol. 51, No. 8, 601–602, 2015.
2. Caillet, M., O. Lafond, and M. Himdi, "Reconfigurable microstrip antennas in millimeter wave," *Proc. 2006 IEEE MTT-S Int. Microwave Symposium Dig.*, 638–641, June 2006.
3. Goshi, D. S., Y. Wang, and T. Itoh, "A compact digital beamforming SMILE array for mobile communications," *IEEE Transactions on Microwave Theory and Techniques*, Vol. 52, No. 12, December 2004.
4. Olver, A. D. and J. U. I. Syed, "Variable beamwidth reflector antenna by feed defocusing," *Microwaves, Antennas and Propagation, IEEE Proceedings*, Vol. 142, No. 5, 1995.
5. Jouade, A., M. Himdi, A. Chauloux, and F. Colombel, "Pattern reconfigurable bended H sectoral horn antenna for high power applications," *IEEE Antennas and Wireless Propagation Letters*, Vol. PP, No. 99, 1–1, 2016.
6. Martin, A., V. Le Neillon, and M. Himdi, "Pattern reconfigurable slot antenna array," *2016 International Symposium on Antennas and Propagation (ISAP)*, paper 1F3-4, 2016.
7. Balanis, A., *Antenna Theory*, 3rd Edition, 671–673, Wiley-interscience, 2005.
8. Barro, O. A., M. Himdi, and O. Lafond, "Reconfigurable patch antenna radiations using plasma faraday shield effect," *IEEE Antennas and Wireless Propagation Letters*, Vol. 15, 726–729, 2016.
9. Barro, O. A., M. Himdi, and O. Lafond, "Reconfigurable radiating antenna array using plasma tubes," *IEEE Antennas and Wireless Propagation Letters*, Vol. 15, 1321–1324, 2016.
10. CST, "Computer Simulation Technology," <http://www.cst.com/>.
11. Jusoh, M. T., M. Himdi, F. Colombel, and O. Lafond, "Performance and radiation patterns of a reconfigurable plasma corner-reflector antenna," *IEEE Antennas and Wireless Propagation Letters*, No. 99, 1137–1140, 2013.