



HAL
open science

A novel right handed circular polarization folded reflectarray antenna at 60 GHz

M.F.M. Yusoff, Ronan Sauleau, Z. Johari, M.K.A. Rahim, H.A. Majid

► To cite this version:

M.F.M. Yusoff, Ronan Sauleau, Z. Johari, M.K.A. Rahim, H.A. Majid. A novel right handed circular polarization folded reflectarray antenna at 60 GHz. *International Journal of Electrical and Computer Engineering*, 2017, 7 (3), pp.1580-1587. 10.11591/ijece.v7i3.pp1580-1587 . hal-01622751

HAL Id: hal-01622751

<https://univ-rennes.hal.science/hal-01622751>

Submitted on 11 Sep 2023

HAL is a multi-disciplinary open access archive for the deposit and dissemination of scientific research documents, whether they are published or not. The documents may come from teaching and research institutions in France or abroad, or from public or private research centers.

L'archive ouverte pluridisciplinaire **HAL**, est destinée au dépôt et à la diffusion de documents scientifiques de niveau recherche, publiés ou non, émanant des établissements d'enseignement et de recherche français ou étrangers, des laboratoires publics ou privés.



Distributed under a Creative Commons Attribution - ShareAlike 4.0 International License

A Novel Right Handed Circular Polarization Folded Reflectarray Antenna at 60 GHz

Mohd Fairus Mohd Yusoff¹, Ronan Sauleau², Zaharah Johari³, Mohamad Kamal A. Rahim⁴,
Huda A. Majid⁵

^{1,3,4} Faculty of Electrical Engineering, Universiti Teknologi Malaysia, Skudai, Malaysia

² IETR, University of Rennes 1, France

⁵ Faculty of Engineering Technology, Universiti Tun Hussein Onn, Malaysia

Article Info

Article history:

Received Feb 14, 2017

Revised Apr 15, 2017

Accepted Apr 30, 2017

Keyword:

Axial ratio

Directivity

Folded reflectarray antenna

LHCPSS

RHCP

ABSTRACT

A novel right-handed circular polarization (RHCP) folded reflectarray antenna with optimized parameters is presented at 60GHz. The RHCP folded reflectarray antenna is designed using left handed circularly polarized selective surface (LHCPSS) Pierrot unit cell. Through simulation, it is shown that the antenna operates well at 60GHz. The maximum antenna directivity is 19dB with a reflection coefficient below -15dB. The radiation patterns showed good responses with side lobes level below -10dB. In addition, the best axial ratio at 60GHz is achieved as 0.75dB.

*Copyright © 2017 Institute of Advanced Engineering and Science.
All rights reserved.*

Corresponding Author:

Mohd Fairus Mohd Yusoff,

Department of Communication Engineering, Faculty of Electrical Engineering,

Universiti Teknologi Malaysia,

81310 Johor bahru, Johor, Malaysia.

Email: fairus@fke.utm.my

1. INTRODUCTION

The rapid development of millimeter wave wireless communication systems and radar systems lead to the increasing demand of the high gain, low-profile and low-cost antenna [1]. Reflectarray antenna (RA) had met the criteria needed which associate the positive characteristic from the reflector antenna and array antenna [2]. Moreover, RA surpassed both antenna by overcoming the bulky size in reflector antenna and avoid the losses caused by the complex feeding network in array antenna [3],[4]. The most compact version of RA known as folded reflectarray antenna (FRA). It introduces the polarizing grid component which reduces the height of RA [5],[6].

In a communication system that uses Circular Polarized (CP) radiation, the rotational orientation of the transmitter and the receiver antennas do not impact the received signal strength. On the other hand, for linearly polarized signals, the reception will be very weak reception if the transmitter and receiver antennas are in orthogonal position. Moreover, a CP antenna can contribute to more enhanced channel performance when compared to a linear polarized (LP) antenna because they can effectively reduce multipath interferences [7]. In this paper, a new right-handed circular polarization (RHCP) folded reflectarray antenna has been designed. More specifically, a folded reflectarray antenna that converts left-handed circular polarization (LHCP) plane wave to RHCP. In this configuration, the left-handed circular polarization selective surface (LHCPSS) is used to reflect LHCP wave source and let reflected RHCP wave pass through it unaffected. It started with the incident wave from the LHCP waveguide is reflected back by the LHCPSS. Then, the reflected LHCP wave is converted to RHCP by the reflectarray reflector. As a result, the reflected

RHCP waves can pass through the LHCPSS and radiates. The basic antenna configuration is shown in Figure 1. All of the antenna designs are simulated using HFSS software and the performances are then evaluated and presented in the results and discussion section.

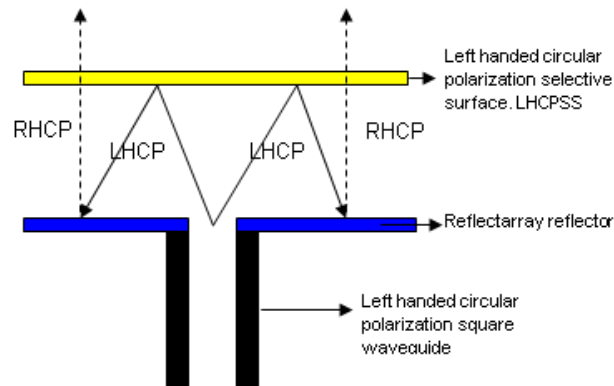

Figure 1. Right handed folded reflectarray antenna basic configuration

2. METHODOLOGY

Three main components have been designed namely circular polarized selective surface, reflectarray reflector surface and full RHCP folded reflectarray antenna. Each design method is explained in the following sub section.

2.1. The Design of Circularly Polarized Selective Surface

An ideal Circularly Polarized Selective Surface (CPSS) is a reciprocal, lossless, perfectly selective, symmetrically structure such that the wave reflected from it will be of the same polarization hand as the incident wave polarization type to which it is sensitized. If a wave of the opposite polarization is then applied, it will be transmitted through the surface. Figure 2 shows an ideal LHCPSS that will entirely reflect an incident left-handed circularly polarized sense, while simultaneously allowing a right-handed circular polarized signal to pass unimpeded through the structure.

Basic Pierrot LHCPSS was chosen and design because of its simple configuration. Figure 3 shows the original LHCPSS Pierrot structure [8] which consist of 1λ bending long wire. Each transverse arm is $3\lambda/8$ long in x and y directions. Meanwhile, the longitudinal section is $\lambda/4$ long in the z direction. The quarter wave section in the z-axis direction ensures that the two linearly polarized components of the incident circularly polarized wave reach the respective dipoles in phase or out of the phase, depending on the incident CP signal.

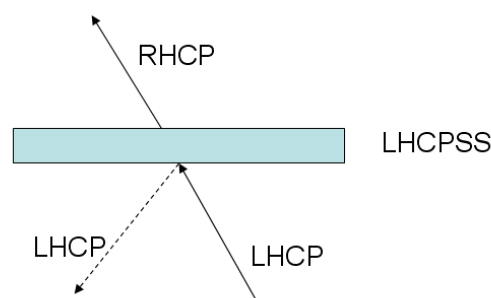

Figure 2. The LHCPSS will reflect back the left-handed circular polarization and let the right-handed circular polarization pass through

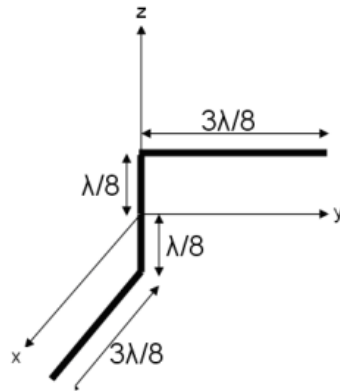

Figure 3. Basic Pierrot CPSS element geometry [8]

The optimized dimensions of the LHCPSS Pierrot unit cell were selected after the parametric studied. Table 1 shows the dimensions of LHCPSS unit cell and the configuration of the LHCPSS unit cell design is shown in Figure 4.

Table 1. Optimized LHCPSS unit cell design

Parameters	Dimension
LHCPSS transverse arm length, l	2.075mm
LHCPSS height, h	1.25mm
Periodicity, p	2.6mm
Arm width, d	0.1mm

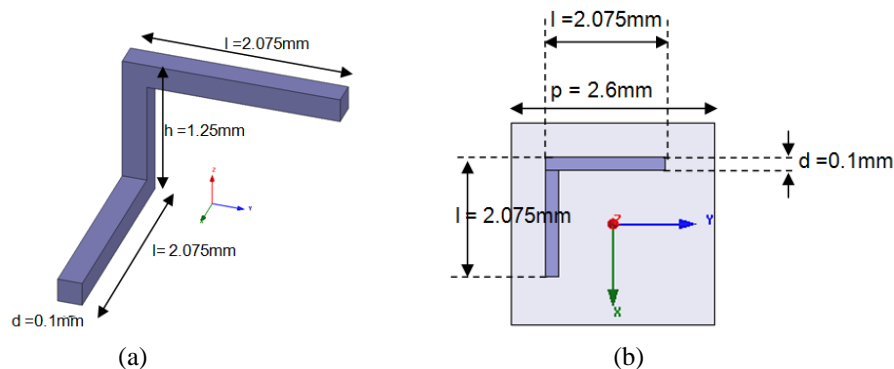

Figure 4. Optimized LHCPSS unit cell configuration (a) 3D view and (b) Top view

2.2. The Design of Reflectarray Reflector Surface

The next component design is the reflectarray reflector. The objective of this component is to convert the LHCP reflected wave from the LHCPSS to RHCP wave and at the same time, compensates the phase delay due the different wave path length so that, the antenna will have broadside radiation. The reflector is made from 11 x 11 unit cell array elements with a spacing of $0.48\lambda_0$ (2.4mm). The substrate chosen to be duriod 5880 material with permittivity, $\epsilon_r = 2.2$ and thickness of 0.254mm. Furthermore, the distance between LHCPSS and reflectarray reflector is given as 6.25mm. Figure 5 shows the layout of 11 x 11 reflectarray reflector surface.

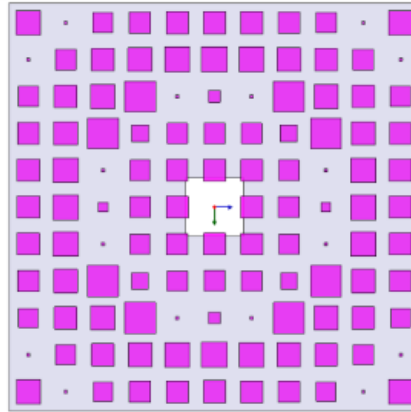

Figure 5. 11 x 11 array elements of reflectarray reflector surface

The unit cell dimensions are depending on the calculated required phase delay coming from the square waveguide phase center to the unit cell positions. To convert LHCP to RHCP waves, the metallic patch of the unit cell of reflectarray reflector is selected to have a square shape so that, the reflected field of E_x and E_y components will not only have similar magnitude but also have 90° reverse phase difference responses. For an ideal LHCP plane wave, the E_y phase is always lagging by 90° compared to E_x component and vice versa for the RHCP wave. The unit cell of reflectarray reflector is shown in Figure 6.

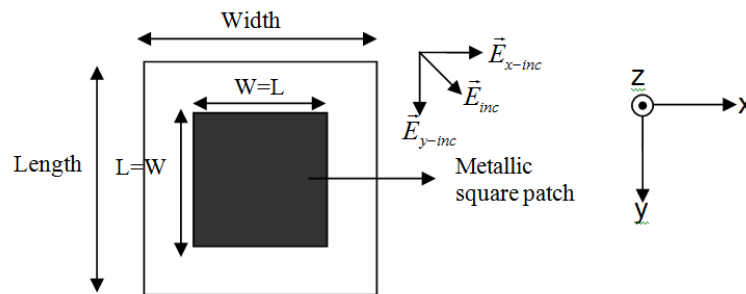
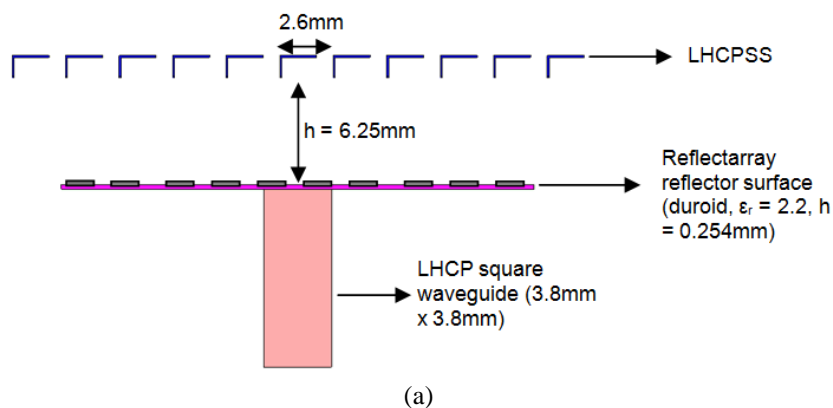

Figure 6. Unit cell of reflectarray reflector

2.3. Full Design of RHCP Folded Reflectarray Antenna

LHCP square waveguide is then designed with a dimension of 3.8mm x 3.8mm. LHCP square waveguide is used as the feed source to illuminate the CP incident wave signal. The complete antenna structure is simulated using full wave HFSS simulation. Figure 7 and Table 2 describe the full antenna configuration and its dimensions.



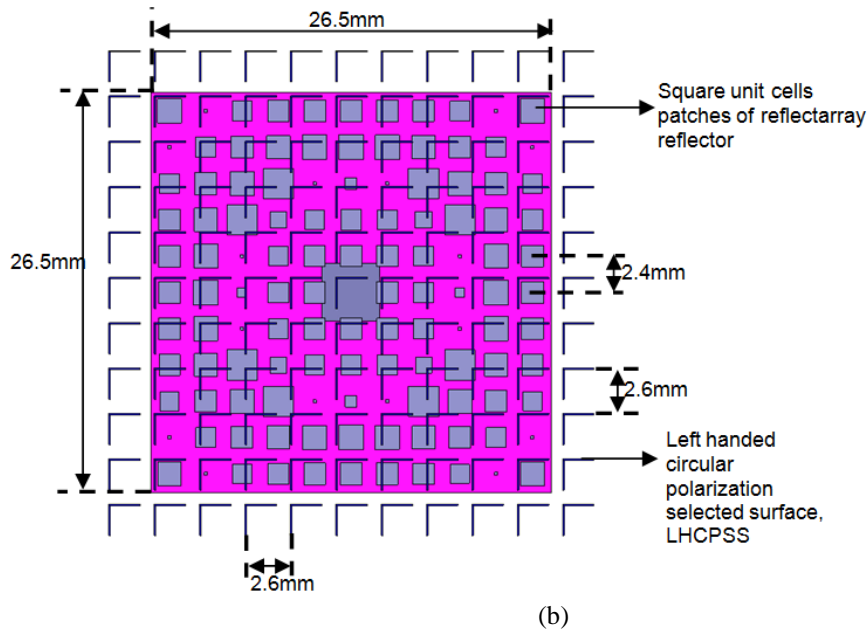

Figure 7. (a) Cross section view and (b) Top view of RHCP folded reflectarray antenna

Table 2. RHCP folded reflectarray antenna dimensions

Antenna Characteristics	Dimensions
Length, L	26.5mm
Width, W	26.5mm
Height, h	6.25mm
Left handed circular polarization selective surface (LHCPS)	Height = 1.25mm LHCPS transverse arm length = 2.075mm Periodicity = 2.6mm Arm width = 0.1mm
Reflectarray reflector unit cells	Varies (0.1mm to 2mm) depending to required phase delay Periodicity = 2.4mm
Reflectarray reflector dielectric substrate	Duroid, $\epsilon_r = 2.2$ h = 0.254mm Tan $\delta = 0.0009$
LHCP square waveguide	Length = 3.8mm Width = 3.8mm

3. RESULTS AND DISCUSSION

Two important terms which are isolation and transmission loss are used to represent the LHCPS performances. The isolation for LHCPS is found by applying the LHCP plane wave illumination. The difference of the LHCP field intensity received with and without the LHCPS inserted in front of the receiver is then measured. On the other hand, the transmission loss is found by measuring the difference of the RHCP field intensity received with and without the LHCPS inserted when the unit cell is illuminated by RHCP plane wave. In theory, in order to have good LHCPS performances, it should have highest isolation value with lowest transmission loss. High LHCPS isolation indicates that most of the incident wave is radiated back from the LHCP surface. Meanwhile, the lowest transmission loss means that the incident wave from the RHCP illumination is passed through the surface with minimum losses.

The simulation result presented in Figure 8 indicates that the LHCPS unit cell has a satisfactory performance at 60GHz. The highest isolation magnitude achieved is 22.7dB with minimum transmission loss 0.7dB at 60GHz.

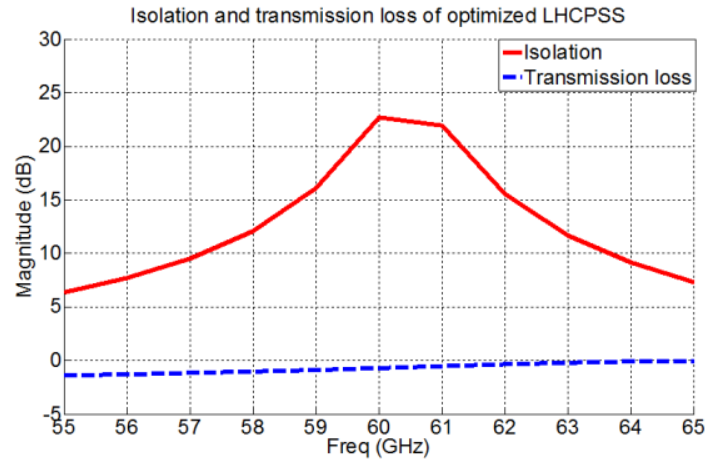
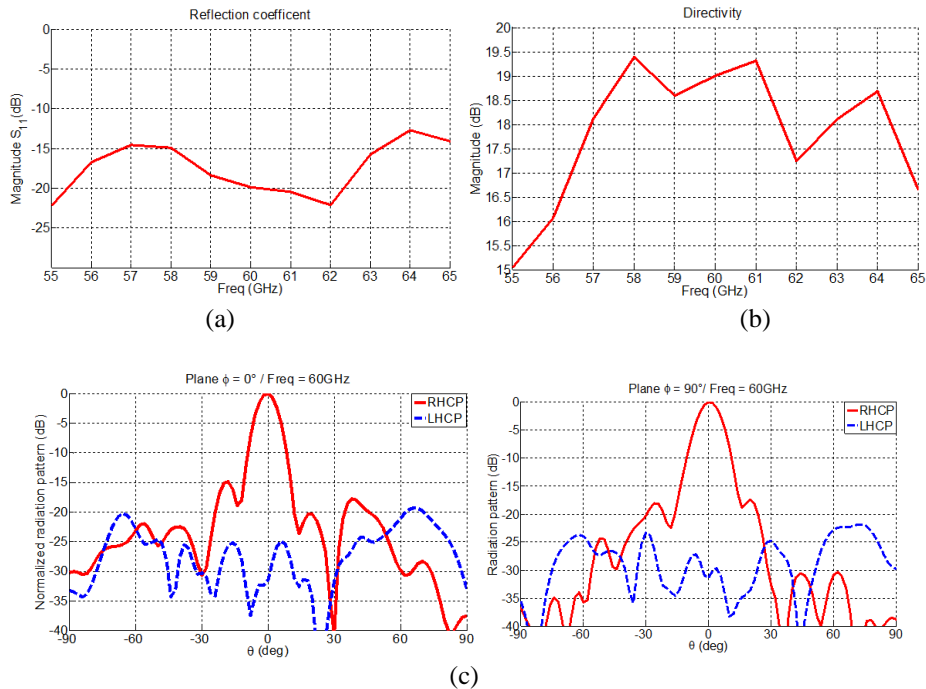

Figure 8. Isolation and transmission loss of optimized LHCPSS unit cell

Figure 9 shows the antenna performances in term of the reflection coefficient, directivity, radiation pattern and axial ratio for the complete folded reflectarray antenna. The simulation results show that the antenna has good performances at 60GHz. The reflection coefficient response is below -10dB for frequency range from 55GHz to 65GHz as can be seen from Figure 9(a). The broadside antenna directivity at 60GHz is obtained as 19dB can be found from Figure 9(b). Meanwhile, the -1dB radiation bandwidth is calculated as 4GHz (57.5GHz to 61.5GHz). Furthermore, the RHCP (co-polarization) radiation patterns also show excellent results with side lobes level below -10dB at 60GHz as evident in Figure 9(c). The LHCP patterns (cross – polarization) depicted a magnitude below -19dB. Finally, the antenna best axial ratio obtained is 0.75dB at 60GHz with 3dB axial ratio bandwidth of 9GHz (55GHz to 64GHz) as shown in Figure 9(d).



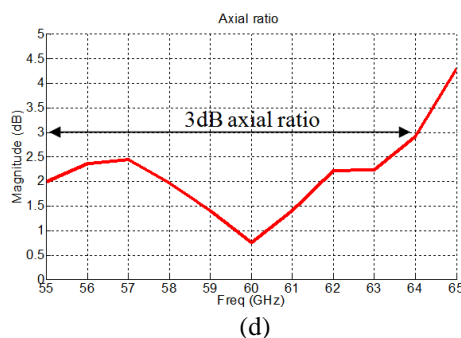

Figure 9. Simulation results of RHCP folded reflectarray antenna (a) Reflection coefficient, (b) Directivity (c) Radiation patterns at 60GHz and (d) Axial ratio

4. CONCLUSION

As a conclusion, the complete design of novel RHCP folded reflectarray antenna has been presented. From the simulation, it is shown that the antenna operates well at 60GHz. The maximum antenna directivity obtained is 19dB with a reflection coefficient below -15dB. The radiation patterns also show good responses with side lobes level below -10dB. Finally, the best axial ratio at 60GHz is achieved as 0.75dB. The outcomes suggest the possibility to convert a left handed circular polarization to right handed circular polarization using LHCPSS structure.

ACKNOWLEDGEMENTS

The authors would like to acknowledge the financial support from Ministry of Higher Education (MOHE) under project QJ130000.2523.09H83 and Research Management Centre (RMC) of Universiti Teknologi Malaysia (UTM). Also thanks to the Institute Electronic and Telecommunications Rennes (IETR) for providing an excellent research environment in order to complete this work.

REFERENCES

- [1] H. John and J. A. Encinar, "Reflectarray Antennas," Piscataway, NJ, IEEE, 2008.
- [2] M. M. M. Ali, *et al.*, "B2. Broadband millimeter-wave rectangular reflectarray antenna utilizing novel polarization insensitive multi-resonant unit cells," *32nd National Radio Science Conference (NRSC)*, pp. 9-16, 2015.
- [3] M. Jiang, *et al.*, "A Folded Reflectarray Antenna with a Planar SIW Slot Array Antenna as the Primary Source," *IEEE Transactions on Antennas and Propagation*, vol/issue: 62(7), pp. 3575-3583, 2014.
- [4] H. T. Chou and M. H. Wu, "Design of an all-metal reflectarray antenna for Ku-band DTV applications," *Radio Science Meeting (Joint with AP-S Symposium), 2014 USNC-URSI*, pp. 43-43, 2014.
- [5] A. E. Mahmoud and A. Kishk, "Folded reflectarray with dually polarized cells," *9th European Conference on Antennas and Propagation (EuCAP)*, pp. 1-4, 2015.
- [6] D. Pilz and W. Menzel, "Printed MM-wave folded reflector antennas with high gain, low loss, and low profile," *Antennas and Propagation Society International Symposium IEEE*, vol 2, pp. 790-793, 2000.
- [7] S. J. Park and S. O. Park, "LHCP and RHCP Substrate-Integrated-Waveguide Antenna Arrays for Millimeter-Wave Applications," *IEEE Antennas and Wireless Propagation Letters*, vol. 99, pp. 1-1, 2016.
- [8] M. Mateusz and Z. Włodzimierz, "Multi-layer meander line polarizer for Ku band," *International Conference on Microwave, Radar and Wireless Communication*, pp. 78 -81, 2000.

BIOGRAPHIES OF AUTHORS



Mohd Fairus is a graduate faculty member of the Faculty of Electrical Engineering, University Technology Malaysia (UTM). He joined UTM in 2002 as a Tutor. He received his Bachelor in Engineering (Electrical-Telecommunication) in 2002 and Master of Electrical Engineering (Electrical - Electronics and Telecommunications) in 2005 from University Technology Malaysia. He obtained his Ph.D in 2012 from University of Rennes 1, France in area of Signal Processing and Telecommunication. His main research interests and areas are antenna design, millimetre waves and microwave devices.

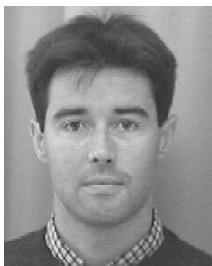

Ronan Sauleau (M'04–SM'06) received the Degree in electrical engineering and radio communications from the Institut National des Sciences Appliquées, Rennes, France, in 1995, the Agrégation degree from the Ecole Normale Supérieure de Cachan, Cachan, France, in 1996, and the Ph.D. degree in signal processing and telecommunications and the Habilitation à Diriger des Recherches degree from the University of Rennes 1, Rennes, in 1999 and 2005, respectively. He was with the University of Rennes 1, as an Assistant Professor from 2000 to 2005, and an Associate Professor from 2005 to 2009. He has been a Full Professor with the University of Rennes 1 since 2009. He has shared the responsibility of the research activities on antennas with the Institute d'Electronique et de Telecommunications de Rennes (IETR), Rennes, in 2010 and 2011. He is currently the Co-Director of the Research Department Antenna and Microwave Devices, IETR, where he is also a Deputy Director. He has been involved in over 35 research projects at the National and European levels and has co-supervised 20 postdoctoral fellows, 35 Ph.D. students, and 48 master's students. He holds ten patents. He has authored or co-authored over 190 journal papers and 400 publications in international conferences and workshops. His current research interests include numerical modeling (mainly FDTD), millimeterwave printed and reconfigurable antennas, substrate-integrated waveguide antennas, lens-based focusing devices, periodic and nonperiodic structures (electromagnetic bandgap materials, metamaterials, reflectarrays, and transmitarrays), and biological effects of millimeter waves.



Zaharah Johari received her Bachelor degree in electronics (2008), Master in Electronics and Telecommunications (2009), and PhD degree from Universiti Teknologi Malaysia (2013). She joined the same university 2008 as a Tutor and currently as senior lecturer in electronics. Her research interests include characterization of semiconductor devices and variability issue in electronics devices.



Mohamad Kamal A Rahim received the B Eng. degree in Electrical and Electronic Engineering from University of Strathclyde, UK, in 1987. In 1989, he joined the Department of Communication Engineering, Faculty of Electrical Engineering Universiti Teknologi Malaysia Kuala Lumpur as an Assistant Lecturer A. He obtained his M.Eng Science from University of New South Wales Australia in 1992 and PhD degrees in Electrical Engineering from University of Birmingham UK in 2003. After he received his Master he was appointed as a Lecturer at Faculty of Electrical Engineering. In 2005 he was appointed as a senior lecturer and in 2007 he was appointed as Assoc Professor at the faculty. Now he is the Professor in RF and Antenna at Faculty of Electrical Engineering Universiti Teknologi Malaysia. His research interest includes the areas of design of Dielectric resonator antennas, microstrip antennas, small antennas, microwave sensors, RFID antennas for readers and tags, Multi-function antennas, microwave circuits, EBG, artificial magnetic conductors, metamaterials, phased array antennas, computer aided design for antennas and design of millimeter frequency antennas.



Huda A Majid received her Bachelor degree in Engineering (Electrical-Telecommunication) (2007), Master in Electrical Engineering (2010), and PhD degree from Universiti Teknologi Malaysia (2013). He currently as senior lecturer in Faculty of Engineering Technology, Universiti Tun Hussein Onn, Malaysia. His research interests include reconfigurable antennas and metamaterial structures.