



**HAL**  
open science

## **Syn-convergence flow inside and at the margin of orogenic plateaus: Lithospheric-scale experimental approach**

Flora Bajolet, Dominique Chardon, Joseph Martinod, Denis Gapais,  
Jean-Jacques Kermarrec

### ► To cite this version:

Flora Bajolet, Dominique Chardon, Joseph Martinod, Denis Gapais, Jean-Jacques Kermarrec. Syn-convergence flow inside and at the margin of orogenic plateaus: Lithospheric-scale experimental approach. *Journal of Geophysical Research*, 2015, 120 (9), pp.6634-6657. 10.1002/2015JB012110 . hal-01229107

**HAL Id: hal-01229107**

**<https://univ-rennes.hal.science/hal-01229107v1>**

Submitted on 16 Nov 2015

**HAL** is a multi-disciplinary open access archive for the deposit and dissemination of scientific research documents, whether they are published or not. The documents may come from teaching and research institutions in France or abroad, or from public or private research centers.

L'archive ouverte pluridisciplinaire **HAL**, est destinée au dépôt et à la diffusion de documents scientifiques de niveau recherche, publiés ou non, émanant des établissements d'enseignement et de recherche français ou étrangers, des laboratoires publics ou privés.



27 **Abstract.** This study investigates three-dimensional flow modes of orogenic plateaus  
28 by means of physical modeling. Experiments consist of shortening two contiguous  
29 lithospheres of contrasting strength, one being a weak plateau-type lithosphere, and the  
30 other a strong craton-type lithosphere. The lateral boundaries are either totally confined  
31 or allow escape toward a lateral foreland on one side. Two syn-convergence flow  
32 regimes are distinguished, which are governed by the balance between the gravity  
33 potential and the strength of the plateau crust and the resistance of its lateral foreland.  
34 The first regime implies transversal (orogen-normal) injection of plateau lower crust  
35 into the collision zone as a result of confinement of the plateau by an increasingly stiffer  
36 lateral boundary. As a precursor mechanism to channel flow, transversal injection  
37 responds to downward thickening of the plateau crust that is forcedly extruded into the  
38 orogenic wedge. The second regime is that of collapse-driven lateral escape of the  
39 plateau. This regime is established after a threshold is attained in the inter-plate  
40 coupling in the collision zone, which allows the gravity potential of the plateau to  
41 overcome the resistance of its lateral boundary. Under the collapse-driven escape  
42 regime (orogen-parallel), such as that governing Tibet during the last 13 Ma, most of  
43 the convergence in the plateau and the top and rear of the collisional wedge is  
44 transformed into lateral flow and extension.

45

46 **Keywords:** crustal flow, analog modeling, lateral escape, extrusion tectonics, orogenic  
47 plateau, hot orogen.

48

## 49 **1. Introduction**

50 Having attained a plateau stage, orogens are hot, owing to their high content in heat-  
51 producing elements due to crustal thickening [*England and Thompson, 1984*] and/or

52 because their mantle lithosphere has been thinned by thermal erosion or removed by  
53 delamination [England and Houseman, 1989; Molnar et al., 1993; Sandiford and  
54 Powell, 1991; Figure 1]. Orogenic plateaus are thus particularly weak due to a reduced  
55 temperature-dependent viscosity of the crust and/or to regional partial melting  
56 [Vanderhaeghe and Teyssier, 2001]. As weak lithospheric regions submitted to  
57 convergence such as long-lived accretionary orogens, cordilleras and wide mature  
58 collision zones, orogenic plateaus deform dominantly by flow, which tends to maintain  
59 a low-relief surface and Moho by responding coevally to body forces due to the  
60 topography and surface forces due to convergence [e.g., England and Houseman, 1989;  
61 Bird, 1991; Chardon et al., 2009].

62 Lateral flow in orogenic plateaus combines orogen normal shortening, forced  
63 tectonic extrusion (driven by forces applied at boundaries) and collapse-driven escape  
64 (gravitational flow) in a context of partial or full mechanical coupling between the  
65 upper mantle and the upper crust [Royden, 1996; Holt, 2000; Tikoff et al., 2004;  
66 Andronicos et al., 2007; Chardon et al., 2011]. Concomitantly, orogen-normal extrusion  
67 of plateau lower crust into the adjoining collision wedge is inferred to occur along a  
68 channel bounded by a thrust at its base and a detachment at its top [i.e., the channel flow  
69 hypothesis; Grujic et al., 1996; Beaumont et al., 2001]. One must therefore consider the  
70 fundamentally three-dimensional aspects of both lateral flow inside the plateau and its  
71 potential interplay with transverse flow at the edge of the plateau. Investigating three-  
72 dimensional deformation of hot orogens is permitted in physical experiments where a  
73 thin/hot model lithosphere is shortened between two quasi-rigid walls [vice models;  
74 Cruden et al., 2006; Cagnard et al., 2006a; Riller et al., 2012]. Similar experiments  
75 have been performed with a cold/thick lithosphere [Davy and Cobbold, 1988].  
76 Nonetheless, a limitation of vice models is that they simulate the shortening of a single

77 type of lithosphere and do not reproduce collision of a plateau with a colder, deformable  
78 lithosphere that would produce an orogenic wedge at the plateau edge. To test three-  
79 dimensional deformation modes of an orogenic plateau, the introduction of such  
80 rheological contrasts should be convenient to simulate mechanical coupling in the  
81 collision zone, which is critical to understand strain partitioning between the plateau and  
82 its foreland [Dewey, 1988] and potential transverse mass transfers across the plateau  
83 edge [Beaumont *et al.*, 2004]. Ratschbacher *et al.* [1991a] modeled lateral flow in  
84 experiments where a strong foreland and a non-deformable indenter flank a weak  
85 lithosphere, with variable degree of lateral confinement. However, the foreland remains  
86 undeformed in almost all experiments and the study focuses on lateral escape.

87 The present study investigates syn-convergence deformation and flow modes  
88 operating inside and at the margin of orogenic plateaus or hot orogens using lithosphere  
89 scaled-analog models. The experiments involve shortening of two contiguous  
90 lithospheres of contrasted strengths, a weak one and thin plateau-type lithosphere, and a  
91 strong, thick and yet deformable craton-type lithosphere. Our experimental setup is  
92 designed to investigate internal deformation of a weak plateau lithosphere being  
93 shortened under various degrees of lateral confinement. It also permits deformation of  
94 the plateau to interact with the stiff lithosphere in the collision zone by simulating  
95 various degrees of coupling between the two lithospheres.

96 We focus on the three-dimensional aspects of mass transfers within and at the  
97 collisional margin of the model orogenic plateau. We show that the evolving strength of  
98 the lateral foreland of the plateau primarily governs the relative magnitude of  
99 transversal (orogen-normal) and longitudinal orogenic flow. We also describe a  
100 potential precursor mechanism to channel flow that consists of forced transversal

101 extrusion of the plateau lower crust as a consequence of downward directed tectonic  
102 thickening of the plateau upper crust.

103

## 104 **2. Experimental setup and scaling**

### 105 *2. 1. Model design and experimental procedure*

106 The model lithospheres float on sodium polytungstate mixed with glycol water,  
107 which is a dense, Newtonian low-viscosity material modeling the asthenosphere (Figure  
108 2). Ductile lithospheric layers are modeled with silicone putties (GSIR gums from  
109 Rhone-Poulenc, France) that are Newtonian fluids at experimental strain rates  
110 [*Weijermars and Schmeling, 1986*]. Dry Fontainebleau sand mixed with ethyl-cellulose  
111 powder is used to simulate the brittle upper crust [*Davy and Cobbold, 1991; Table 2*].  
112 The strong cold cratonic lithosphere consists of a brittle upper crust, a ductile lower  
113 crust and a thick and dense high-viscosity lithospheric mantle (Figure 2a). The latter  
114 simulates the upper part of the lithospheric mantle, which concentrates most of the  
115 strength. The weak hot plateau lithosphere is modeled as a three-layer crust (i.e., a  
116 lithosphere lacking its mantle part). The model consists of a brittle upper crust, a ductile  
117 mid-crust and a low-viscosity lower crust simulating partial melting-induced weakening  
118 (Figure 2a). The model is placed in a Plexiglas box equipped with a moving-wall  
119 coupled with a piston and a motor to control shortening. Velocity discontinuities made  
120 of Plexiglas plates placed on each lateral wall of the box help to localize deformation  
121 away from the moving-wall and to limit boundary effects (Figure 2). Eleven  
122 experiments were performed in laterally confined conditions (Figure 2a, Table 1). Three  
123 experiments were performed at a medium to low lateral confinement, allowing lateral  
124 escape of the model during convergence (Figure 2b). In that case, the same type of  
125 model as that of laterally confined experiments was placed in a larger box, adjacent to a

126 confining silicone capable of absorbing the escape of the shortened lithospheres (Figure  
127 2b). All experiments were performed at constant room temperature. There is no thermal  
128 evolution of the system, density contrasts between the layers remain constant, and we  
129 neglect the role of thermal diffusion and phase changes.

130 During each experiment, photographs were taken in order to map successive stages  
131 of surface deformation (e.g., Figure 3). At the end of the experiment, the model is  
132 frozen for at least 12 hours. There is no significant post-experiment deformation  
133 because: (1) shortening is no longer active, (2) the viscosity of the silicone decreases  
134 rapidly with decreasing temperature and the sudden drop in temperature prevents it  
135 from flowing, (3) comparison between the last top view photo and the frozen cross-  
136 sections shows similar faults locations. Then the lithospheric part of the model is  
137 detached from the sodium polytungstate, buried in sand and wetted. The protective  
138 sand-shell is also frozen, the block formed by the model lithosphere and the sand is then  
139 cut with a circular saw to obtain serial cross-sections. For practical reasons related to  
140 model preparation, the two lithospheres share the ductile crustal layer of intermediate  
141 viscosity (DC; Figure 2). In the cratonic lithosphere, this layer models the whole lower  
142 crust, whereas in the weak lithosphere it simulates the middle crust. Model setting  
143 implies that the weak lithosphere is initially weaker than the craton and bears a 50 km-  
144 thick crust at the onset of shortening. Such a setting is convenient to model an advanced  
145 stage in collision and crustal thickening, which is for instance consistent with the  
146 Neogene configuration of the Tibet-Himalaya system [e.g., *Replumaz et al.*, 2010c].

147

## 148 *2. 2. Scaling, limitations of the models and tested parameters*

149 In order to perform experiments comparable with nature, geometric and dynamic  
150 similarities must be respected [*Davy and Cobbold*, 1991]. This is verified if the relation

151  $\sigma^* = \rho^* g^* L^*$  (1)

152 is respected [Brun, 2002], where  $\sigma^*$ ,  $\rho^*$ ,  $g^*$ ,  $L^*$ , are the ratio between model and nature  
153 for stress, density, gravity and lengths, respectively. All experiments were performed  
154 under natural gravity, thus  $g^* = 1$ . The scaling factor for length is  $L^* = 5 \times 10^{-7}$ , i.e. 1 cm  
155 in experiments is 20 km in nature. In the brittle layers, the differential stress obeys the  
156 Coulomb criterion. In the ductile layers, the shear stress is

157  $\tau = \eta \, d\varepsilon/dt$  (2)

158 where  $\tau$  is the shear stress,  $\eta$  the shear viscosity, and  $d\varepsilon/dt$  the shear strain rate.

159 The shear strain rate  $d\varepsilon/dt$  depends strain localization (faulted or undeformed regions)  
160 and evolves through time. A good approximation of the bulk shear strain rate (for the  
161 entire model and whole duration of the experiment) is

162  $d\varepsilon/dt \sim V/L$  (3)

163 where  $V$  is the imposed shortening rate and  $L$  the length of the shortened area. Equation  
164 (2) is then equivalent to

165  $\tau \sim \eta V/L$  (4)

166 In all experiments, the brittle layer is modeled using a mix of dry sand and ethyl-  
167 cellulose powder whose cohesion is negligible. According to Schellart [2000] and  
168 Lohrman *et al.* [2003], the friction coefficient of sprinkled sand varies between 0.5 and  
169 1.2 for sifted sand and for the range of normal stresses considered in our experiments. In  
170 order to estimate the friction coefficient of the sand we evaluated the dip of reverse and  
171 normal faults in simple experiments, and we concluded that the friction angle is  $\sim 30^\circ$   
172 for the sprinkled sand we used, i.e. the friction coefficient is close to 0.6. The viscosity  
173 of the silicone layer that models the ductile lithosphere varies between  $9.5 \times 10^3$  Pa s  
174 and  $3.81 \times 10^4$  Pa s (Table 2). Figure 2 shows the strength profiles of the weak and  
175 cratonic lithospheres for the reference experiment, strength values being summarized in



176 Table 3. The overall model strength profiles for the lithospheres respect the scaling law  
177 (Figure 2) and makes our experiments comparable with nature. However, the ratio  
178 between the viscosity of lithospheric layers and that of the asthenosphere is  $\sim 3 \times 10^4$ ,  
179 which is more than one order of magnitude larger than in nature [Loiselet *et al.*, 2009;  
180 Schellart, 2010]. In our experiments, the asthenosphere essentially exerts normal  
181 hydrostatic stresses on the lithosphere. This should not affect fundamentally the  
182 evolution of our experiments, since neither a subduction zone nor any large deformation  
183 appear at the lithosphere/asthenosphere boundary in the models. In our experiments,  
184 lithospheric deformations only result from the applied boundary conditions and from  
185 the collapse of lithospheric plates, not from asthenospheric fluxes.

186 Model lithospheres respect the scaled ratio of crust density over lithospheric mantle  
187 density (Table 2). For practical reasons, the density of the asthenosphere in the models  
188 is higher than that of the lithospheric mantle (1.75 and 1.56 respectively) whilst they are  
189 of the same order in nature. This has an impact on the gravity potential of the  
190 lithospheres that is overestimated. We calculated Argand numbers ( $Ar$ ) characterizing  
191 the ratio of body forces over tectonic forces, to check if body forces alone are large  
192 enough to result in lateral escape (Appendix A, Table 4).

$$193 \quad Ar = F_B/F_T \quad (5)$$

194 If  $Ar > 1$ , the lithosphere is unstable and can potentially collapse; whereas for  $Ar < 1$  the  
195 body forces may be supported by the strength of the lithosphere. This number is  
196 increased by a factor  $\sim 2$  when the density of the liquid modeling the asthenosphere rises  
197 from 1.56 to 1.75. Hence, lateral escape is favored in our experiments if permitted by  
198 lateral boundary conditions (unconstrained experiments). In nature, many other  
199 phenomena that are not reproduced in experiments may also favor lateral escape, as for  
200 instance, the subduction of an oceanic plate of the lateral foreland that would modify the

201 lateral traction exerted on the collision zone, as in SE Asia for the Tibetan plateau. Our  
202 unconfined experiments reproduce the deformation of a continental collision zone in  
203 which the lateral tectonic boundary conditions favor lateral escape. On the other hand,  
204 confined experiments show the evolution of a craton/plateau collision zone in which  
205 lateral boundary conditions oppose it. Another limitation of our models is that they do  
206 not reproduce the early stages of oceanic and continental subduction, which implies that  
207 we neither take into account the influence of inherited structures from these stages, nor  
208 simulate processes such as pre-collisional subduction, back arc extension, or slab-break-  
209 off. We choose analog materials that reproduce a mature plateau (weak and thick crust),  
210 corresponding to the collisional stage. Although no oceanic subduction occurs, the  
211 continental cratonic lithosphere underthrusts the plateau along a large-scale shear zone  
212 and reproduces a realistic collision dynamics at the suture (see below).

213 The impact of several parameters has been tested: (1) the shortening velocity, which  
214 sets the strength of the ductile layers and the degree of brittle-ductile lithospheric  
215 coupling, (2) the thickness and viscosity of the crustal ductile layers to test different  
216 strength contrasts amongst crustal layers and between the plateau and cratonic  
217 lithospheres, and (3) the thickness of the silicone layer that opposes lateral escape  
218 (Table 2).

219

### 220 **3. Results**

221 Performing an experiment with the same experimental settings twice and stopping  
222 them at two different amounts of shortening allowed us to reconstitute successive  
223 deformation stages in cross-section view. Comparison of the serial cross-sections of a  
224 same model also helps constraining the sequential development of the structures given  
225 the lateral gradient of finite shortening existing between the sides of the box (near the

226 velocity discontinuity generated by the tip of the lateral wall of the piston) and its center  
227 (Figures 2 and 3). In all the figures, the weak lithosphere is placed on the left hand side  
228 of the maps and cross-sections. In the text, pro-thrusts designate thrusts verging towards  
229 the cratonic foreland (the pro-side of the orogen), whilst retro-thrusts designate thrusts  
230 verging towards the hinterland (the retro-side of the orogen).

231

### 232 3. 1. Laterally confined experiments

#### 233 3. 1. 1. Structures and kinematic evolution

234 There is a remarkable consistency in the development mode of the structures and  
235 flow patterns in all the laterally confined experiments. Upper crustal shortening first  
236 affects the weak lithosphere, which absorbs ca. 70% of the total shortening. From 3-4%  
237 of shortening, a first series of retro-thrusts forms in the weak lithosphere, each fault  
238 evolving into a conjugate couple of reverse faults delimiting pop-downs [e.g., Figure 4c  
239 and 4d; see *Cagnard et al.*, 2006b]. Each conjugate fault set is abandoned when a new  
240 pop-down forms. In experiments with contrasted brittle crust thicknesses between the  
241 two types of lithospheres (Figures 4b to 4d, 4f and 5), the last conjugate fault set forms  
242 at the lithosphere boundary at 10-15% shortening. It remains active until the end of the  
243 experiment. The retro-thrust of this late conjugate couple is predominant.

244 Shortening of the cratonic crust is localized along a limited number of thrusts  
245 delimiting pop-ups, which become generally inclined or overturned cratonwards 3-5%  
246 of shortening after they form (e.g., Figures 3, 4a, 5). Ductile layers are generally  
247 thickened, especially the low-viscosity lower crust in the weak lithosphere, whose  
248 thickness is doubled after 30% of shortening (Figures 3 and 4). The mid-crust of the  
249 plateau is thickened as much as its weak lower crust; whereas the ductile cratonic crust  
250 undergoes less thickening (25% after 30% of bulk shortening).

251 The plateau lower crustal layer is thrust upon the cratonic lithospheric mantle,  
252 initiating continental scale underthrusting of the cratonic mantle along a pro-shear zone.  
253 This lithospheric shear zone is shown in Figures 3 to 5 by white arrows. The plateau  
254 lower crustal layer keeps a flat floor and thickens as a symmetrical dome (Figure 3) that  
255 becomes overturned above the lithospheric pro-shear zone (Figures 4a to 4d).  
256 Asymmetrical doming results in a wedge shape of the plateau lower crust, whose roof  
257 makes the back limb of the dome and dips toward the hinterland. As the dome  
258 amplifies, it is obliquely injected into the cratonic lower crust, which is in turn  
259 underthrust beneath the inverted limb of the dome (Figures 4a to 4d). A far-field  
260 channel flow effect is produced in the cratonic lower crust by injection of plateau lower  
261 crust into the foreland (e.g., Figure 4e).

262 The back-limb of the dome shows upright mullions or folds interpreted as a  
263 consequence of distributed shortening (Figures 4a to 4d). This attests to limited crustal-  
264 layering parallel shearing at the roof of the weak lower crust and to dominant  
265 homogeneous thickening of the plateau at the rear of the dome. This also means that  
266 part of the mid crust of the weak lithosphere is transported cratonward on the roof of the  
267 weak lowermost crust. The top of the dome, once amplified, is taken into a flat retro-  
268 shear affecting the upper mid-crust, which is marked by backward deflection of former  
269 mullions or folds at the dome's crest (Figures 4b, 4d, 5). This shear zone emerges as the  
270 last active retro-thrust making the boundary of the plateau crust (Figures 4b, 4d, 5). The  
271 boundary between the two types of brittle crusts migrates twice as much more towards  
272 the hinterland than the intersection between the underthrusting shear plane and the  
273 asthenosphere. This explains the large magnitude of mid- and upper crustal back  
274 shearing above the overflowing lower crust of the weak lithosphere. In the cratonic  
275 lithosphere, the last pro-thrust propagates upward from the underthrusting shear zone

276 (e.g., Figures 4d and 5). Importantly, no net unroofing of the plateau weak lower crust  
277 occurs as a consequence of doming and lower crust overflow. Indeed, the crest of the  
278 dome does not attain shallower depths than the initial depth of the top of the plateau  
279 weak lower crustal layer.

280

### 281 3. 1. 2. Sensitivity to parameters

282 The shortening velocity, by controlling the degree of coupling between the  
283 lithospheric layers, affects the style of deformation. For a high velocity, thrusts remain  
284 active for a shorter time period and are abandoned more quickly. An increase in  
285 coupling (higher velocity) is also expressed by earlier faulting in the cratonic crust, and  
286 a greater dip and lower finite displacement of the lithospheric shear zone ( $45^\circ$  for 4 cm  
287  $\text{h}^{-1}$  in Figure 4c against  $20^\circ$  for  $0.4 \text{ cm h}^{-1}$  in Figure 4d). An increased strength (i.e.  
288 velocity) also leads to less backward displacement of the suture. Therefore, for a high  
289 degree of coupling, shortening is preferentially accommodated by thickening instead of  
290 by underthrusting and/or injection.

291 Using the same thickness of the brittle crust over the entire model favors pro-thrusts  
292 and pop-downs between 20 and 30% of shortening (Figures 3 and 4a). Finally, changing  
293 the thickness and rheology of the plateau crust to highly over-thickened and less viscous  
294 (Figures 4e and 4f) favors distributed deformation and limited stacking of pop-downs in  
295 the plateau. In this situation, instead of dipping towards the hinterland, the roof of the  
296 plateau lower crust is either flat or cratonward dipping, which suggests an active role of  
297 the gravitational potential of the thickened crust on the dynamics of cratonward  
298 extrusion.

299

### 300 3. 2. *Experiments with lateral escape*

### 301 3. 2. 1. Structures and kinematic evolution in map view

302 In this section, we will first describe experiment F2 (Figure 6), taken as a reference  
303 experiment. We will then evaluate the effect of an increased shortening velocity  
304 (experiment F3, Figure 7) and of an increased strength of the silicone layer opposed to  
305 lateral escape (experiment F1, Figure 8). The term external refers herewith to the part of  
306 the model located close to the boundary where lateral escape is permitted; whereas the  
307 term internal, which refers to the confined boundary side of the model.

308 From the beginning of the experiment, the entire model escapes laterally, forming an  
309 outwardly convex arch. Deformation nucleates as conjugate strike-slip fault sets  
310 affecting both lithospheres (Figure 6). The main intersection between these faults  
311 defines a sag basin marking the transition between an internal domain dominated by  
312 reverse faulting and transpression, and an external domain dominated by extension and  
313 transtension (Figure 6). As shortening increases (16%), the plateau lithosphere  
314 concentrates the deformation by developing an anastomosing network of longitudinal  
315 transpressive faults (pro and retro) that propagate towards the external domain in the  
316 form of conjugate strike-slip faults (Figure 6). Between 7.5 and 21 % shortening, a  
317 retro-thrust nucleates and propagates at the boundary of the two lithospheres. The  
318 hinterland-side fault system of the plateau is abandoned and the rest of the plateau fault  
319 network is shortened and laterally elongated as a result of fault rotations. A new dextral-  
320 oblique thrust propagates obliquely across the cratonic lithosphere by joining the piston  
321 and the plateau. This fault defines the front of the external triangle-shaped half of the  
322 cratonic lithosphere that is deformed. Continuous widening and clockwise rotation of  
323 the grabens attest to combined lateral stretching and dextral shearing of that triangle  
324 which responds to faster lateral stretching and escape of the plateau lithosphere  
325 compared to the cratonic lithosphere. Overall shortening induces partitioning of the

326 deformation between the two lithospheres. The cratonic lithosphere undergoes limited  
327 shortening and heterogeneous lateral extension. The weak lithosphere deforms by bulk  
328 homogeneous pure shear deformation, which is accommodated by an anastomosing  
329 network of transpressive faults [*Cagnard et al.*, 2006a; *Cruden et al.*, 2006; *Riller et al.*,  
330 2012]. To summarize, transverse shortening and lateral escape of the plateau by bulk  
331 pure shear induce a combination of heterogeneous simple shear and pure shear in the  
332 cratonic lithosphere (Figure 9).

333       Increasing the strength of the ductile layers by increasing the velocity of shortening  
334 leads to a lesser amount of lateral escape (experiment F3; Figure 7), especially if  
335 compared to the amount of shortening (Figure 10d). The smaller thickening/escape ratio  
336 in this experiment results from the weaker influence of body forces due to density  
337 contrasts compared to forces arising from convergence velocity. The plateau lithosphere  
338 undergoes more escape than the cratonic lithosphere. The retro-thrust at the lithospheric  
339 boundary does not propagate beyond the central sag basin (Figure 7). Deformation  
340 concentrates along the hinterland side of the plateau and over its entire length by  
341 activation of successive straight thrusts (Figure 7). On both sides of the sag basin, two  
342 large areas of the plateau remain nearly undeformed against the hinterland deformation  
343 belt (Figure 7). Though not visible, deformation occurs at the lithospheric contact in the  
344 external part of the model since diffuse shear is required along this boundary in order to  
345 explain higher differential escape of the plateau. To summarize, an increased strength of  
346 the ductile layers caused by a higher shortening velocity induces (1) smaller amount of  
347 lateral escape compared to the amount of shortening, (2) differential escape of the  
348 plateau and therefore partial decoupling between the two lithospheres, (3) strain  
349 partitioning inside the plateau, and (4) limited deformation of the cratonic lithosphere  
350 (Figure 9).

351 For a strength and thickness of the lateral silicone three times that of experiments F2  
352 and F3, the cratonic lithosphere remains virtually undeformed until late stages of  
353 shortening, and the plateau is indented and partly escaped (experiment F1; Figure 8).  
354 Bulk pure shear strain of the plateau lithosphere is achieved by an anastomosing  
355 network of transpressive faults due to the densification and rotation of an early strike-  
356 slip conjugate fault network. Spreading in the escaped plateau peninsula is  
357 accommodated by normal faults having a strike-slip component (Figure 8). To  
358 summarize, an increase in strength at the lateral boundary favors decoupling between  
359 the two lithospheres, pure shear assisted escape of the plateau, and spreading confined  
360 to the escaped part of the weak lithosphere (Figure 9).

361

### 362 3. 2. 2. Structures and kinematic evolution in cross-section

363 As a significant part of the convergence is absorbed by lateral escape at the  
364 earliest stages of shortening, cross-sections of the free boundary experiments provide  
365 insights into the earliest stages of convergent deformation. In the inner part of the  
366 model, the earliest increments of shortening are accommodated by indentation of the  
367 plateau lower crust by the cratonic lithospheric mantle (Figures 6 and 7). The future  
368 overflowing dome of plateau lower crust initiates as a result of this indentation, which is  
369 also accompanied by doming of the cratonic mantle (Figures 6 and 7). The retro-thrust  
370 marking the lithosphere boundary in the upper crust may possibly be related to the early  
371 indentation process (Figures 6 and 7). In the external part of the model, the two domes  
372 involved in the indentation process either never appeared, or collapsed. The net throw of  
373 the retro-thrust is greater than in the internal part of the model (Figures 6 and 7). This is  
374 interpreted as a consequence of escape-enhanced lateral thinning of the plateau  
375 lithosphere (see below).



376

### 377 3. 2. 3. Three-dimensional analysis

378 We performed a three-dimensional finite strain analyses (Appendix B) to  
379 quantify the deformation along the principal axis of the strain ellipsoid  $\lambda_1$  (maximum  
380 elongation),  $\lambda_2$  (intermediate) and  $\lambda_3$  (maximum shortening). It shows that  $\lambda_1$  is  
381 horizontal and orogen-parallel and  $\lambda_3$  is horizontal and orogen-normal in the plateau  
382 lithosphere in all experiments with lateral escape (Figure 9). A general transition is  
383 documented from vertical flattening in the internal part of the plateau to horizontal  
384 plane strain or constriction in the external part of the plateau (Figure 9). For strong  
385 coupling between the two lithospheres (experiment F2; Figures 6 and 9), flow toward  
386 the lateral boundary compensates thickening, and the external domain of the plateau is  
387 deformed by horizontal plane strain. For partial decoupling between the two  
388 lithospheres resulting from a higher shortening velocity (experiment F3; Figures 7 and  
389 9), lateral constriction in the external part of the plateau lithosphere attests to a  
390 component of thinning superimposed on orogen-normal shortening. Horizontal  
391 constriction prevails in the cratonic lithosphere in response to combined lateral  
392 stretching and vertical thinning [*Merle and Gapais, 1997; Teyssier and Tikoff, 1999*].  
393 No cross-sections are available for the indentation experiment characterized by a higher  
394 strength of the confining silicone (experiment F1; Figures 8 and 9c), but surface  
395 deformation shows that the cratonic lithosphere remains virtually undeformed.  
396 Conversely, one may expect stronger vertical flattening in the internal part of the  
397 plateau lithosphere. The presence of normal faults in the escaped peninsula (Figure 8,  
398 9c), attests to significant thinning due to spreading. To summarize, lateral finite thinning  
399 of the weak lithosphere characterizes the three experiments.

400 Strain intensities (Appendix B) are of the same order of magnitude for F2 and F3  
401 experiments, and always lower for the cratonic lithosphere (from 0.7 to 1.5) than for the  
402 weak lithosphere (from 1.1 to 1.7). In the weak lithosphere, the strain intensity  
403 parameter  $\varepsilon_s$  [Nadai, 1950] is minimum at the center of the model (Table 4), maximum  
404 at the external boundary, and intermediate in the internal domain. This is interpreted as  
405 the superimposition of thickening near the confined wall onto a strain gradient due to  
406 the laterally increasing component of longitudinal stretching. Higher strain intensity  
407 near the lateral boundary is interpreted as the result of the superimposition of a  
408 gravitational component of flow onto the bulk shortening strain ellipsoid. Strain  
409 intensities in the cratonic lithosphere, though very low, also increase towards the lateral  
410 boundary (Table 4).

411 Lateral escape patterns for strong coupling (F2 experiment) or partial coupling (F3  
412 experiment) between the two lithospheres are comparable (Figures 10b and 10c).  
413 Lateral escape is fast at the beginning and decreases rapidly within 5 hours to a nearly  
414 steady value (Figures 10b and 10c). In experiment F2, early escape is accommodated by  
415 overall thinning of model lithospheres (total escaped area greater than the area lost by  
416 the advance of the piston up to 6 hours time; Figure 10b). At the end of both  
417 experiments, total lateral escape had roughly accommodated half of the area lost by the  
418 advance of the piston, the remaining half of which having been absorbed by lithospheric  
419 thickening (Figures 10b and 10c). In the experiment with a thicker confining silicone  
420 (F1; high strength of confining silicone, complete decoupling between the two  
421 lithospheres, indentation of the weak lithosphere by the craton), lateral escape evolves  
422 linearly with time. The escaped surface consists exclusively of weak lithosphere and  
423 remains low even at the end of the experiment ( $50 \text{ cm}^2$  vs.  $150 \text{ cm}^2$  for experiments F2  
424 and F3; Figure 10a to 10c). This analysis suggests that lateral escape is far more

425 sensitive to the resistance at the lateral boundary than to the strength of the lithospheres,  
426 as observed in experiments by *Ratschbacher et al.* [1991a].

427 The evolution of the gravity potential and stability of the model lithospheres may be  
428 quantified using the Argand number ( $Ar$ ; eq. 4 and Appendix A). We calculated  $Ar$  of  
429 the cratonic and weak lithospheres for the initial and final configurations of the  
430 experiments (Table 4; Figure 9). This parameter depends on the buoyancy of the  
431 lithospheric mantle that is overestimated in our models (Table 2). Consequently,  $Ar$  is  
432 also overestimated (up to a factor 2), and collapse of the model resulting in lateral  
433 escape is favored by the density layering we adopted. As discussed in section 2.2, other  
434 processes not reproduced in our models can favor lateral spreading of the plateau. Then,  
435 this choice in the parameters may simulate natural situations, for example when lateral  
436 oceanic subduction zone occurs while the collision is active, as it is the case in SE Asia.

437 In all experiments, the cratonic lithosphere is also potentially unstable at the  
438 beginning of the experiment ( $Ar > 1$ ). This is attested by the development of grabens and  
439 deformation leading to lateral constriction. Nonetheless, the significant differential  
440 finite strain and lateral escape undergone by the two lithospheres is enhanced by a  
441 higher strength of the cratonic lithosphere compared to the weak lithosphere. Although  
442 the cratonic lithosphere is potentially unstable, its resistance prevents a rapid collapse.  
443 Collapse efficiency and velocity also depend on the resistance at the lateral boundary  
444 and on the degree of coupling between the two lithospheres, which are not taken into  
445 account in the expression of the Argand number. Furthermore, when the two  
446 lithospheres are coupled (experiments F2 and F3), lateral stretching of the cratonic  
447 lithosphere primarily adjusts to lateral escape of the deforming weak lithosphere (Figure  
448 9). The above considerations suggest that despite the experimental limitations, the

449 dynamic analysis of deformation inside and at the collisional boundary of the weak  
450 lithosphere remains valid.

451 In experiment F1 including a thick lateral confining layer (Figure 8, Table 4), the  
452 initial negative Argand number of the weak lithosphere is not realistic for simulating an  
453 orogenic plateau. These initial experimental conditions may rather simulate a thin hot  
454 back arc domain precursor of an orogenic plateau. During experiment, the thickening of  
455 the weak lithosphere increases its Argand number, which should in turn favor lateral  
456 escape. Then, the weak lithosphere should not escape right away, but only after a  
457 significant amount of shortening-induced thickening. However, lateral escape takes  
458 place with a constant rate during the entire the experiment (Figure 10a). This apparent  
459 inconsistency shows that horizontal stresses resulting from the shortening of the weak  
460 lithosphere are larger than horizontal stresses arising from density contrasts with the  
461 lateral confining medium. In these conditions, part of the shortening is accommodated  
462 by lateral escape. Such a configuration reflects a forced tectonic extrusion mechanism  
463 such as that modeled by *Tapponnier et al.* [1982] and in the strongly confined  
464 experiments of *Ratschbacher et al.* [1991].

465 For strong (F2 experiment) or partial (F3 experiment) coupling between the two  
466 lithospheres (case of a weaker lateral foreland), the initial Argand number of the weak  
467 lithosphere is significantly higher than that of the cratonic lithosphere (Table 4). At the  
468 beginning of experiments, the main driving mechanism of escape is collapse, as attested  
469 by the evolution of the escape versus thickening ratio through time (Figure 10d).  
470 Collapse-driven escape is fast at the early stages of the experiment. As the lateral  
471 foreland thickens with time, the Argand number of the plateau drops and the escape rate  
472 decreases accordingly and eventually stabilizes (Figure 10b, 10c, and 10d). At that  
473 stage, the models become governed by forced tectonic extrusion in a configuration that

474 is close to that of experiment F1 with a high strength lateral foreland. In other words,  
475 the evolving strength of the lateral foreland exerts a prime control on the dynamics of  
476 hot orogens, particularly on their capacity to collapse laterally. Such an influence is  
477 similar to that observed by *Davy and Cobbold* [1988].

478

#### 479 **4. Discussion**

480 Models describing the dynamics of the Himalaya-Tibet orogen should be consistent  
481 with geological observations, earthquakes distribution and deep structure. Several  
482 models have addressed these issues. For example *Grujic* [1996] or *Beaumont et al.*  
483 [2001; 2004] focused on the transverse mass transfers in the collision zone, and *Royden*  
484 *et al.* [1997, 2008], *Clark and Royden* [2000] try to explain the topographic gradient and  
485 lateral escape at the eastern edge of the plateau. The differences between the frontal and  
486 lateral margins arise from boundary conditions (collision with strong lithosphere vs.  
487 partially free boundary, respectively), deep structure (underthrusting of India or not),  
488 orientation with respect to the direction of convergence (parallel vs. perpendicular) and  
489 surface factors (climate, erosion rates). This results in different crustal flow modalities  
490 and timing. For the south margin of the plateau, the channel flow model explains  
491 exhumation of high grade rocks (High Himalayan Crystalline) bounded by a thrust at its  
492 base (Main Central Thrust, MCT) and a detachment at its top (South Tibetan  
493 detachment, STD) alongside with focused erosion at the surface. Cratonward injection  
494 of plateau lower crust in the collision zone as observed in our 2D models provides  
495 insights into the channel flow process (Figures 3 and 4). At the eastern margin of the  
496 Tibetan plateau, eastward flow of weak lower crust material without exhumation could  
497 explain the topographic gradient and GPS motions in the area. The lateral flow patterns  
498 of our 3D models (Figures 6 to 8) allow addressing the mechanism of eastern growth /

499 escape of the Tibetan plateau. It is important to consider that despite their obvious  
500 kinematic differences, both the transverse and lateral flow processes are ultimately  
501 driven by gravitational collapse and/or forced tectonic extrusion of plateau lower crust  
502 [Bird, 1991; Royden *et al.*, 1997; Shen *et al.*, 2001; Beaumont *et al.*, 2004]. In the  
503 discussion, we shall first focus on strain partitioning at the surface and at depth, then on  
504 the transversal flow at the India-Asia plate boundary, and finally discuss three-  
505 dimensional aspects of the interplay between transversal and lateral flows. As our  
506 models do not involve erosion or temperature variations, we shall not discuss surface  
507 processes or metamorphism issues.

508

#### 509 *4.1. Strain partitioning and kinematics*

510 In the Himalaya-Tibet orogen, strain is spatially partitioned, with dip-slip reverse  
511 faulting at the orogenic front and transpression in the syntaxes and north of the Kunlun  
512 fault, whereas the plateau undergoes transtension, and strike-slip deformation dominates  
513 East of the Longmen Shan and Xianshuihe fault [Andronicos *et al.*, 2007]. Our models  
514 reproduce well most of this pattern. In 2D and 3D, thrusting initiates at the lithospheres  
515 boundary and at the backstop at early stages, with a strike-slip / transpressive  
516 deformation component for 3D models forming anastomosed fault networks (e.g.  
517 Figures 3 and 6). This confirms recent studies challenging the view of reverse thrusting  
518 propagating from the suture to the North [e.g. Tapponnier *et al.*, 2001] and attesting  
519 distributed deformation in the plateau with Paleocene/Eocene faulting in north Tibet  
520 [e.g. Zhang *et al.*, 2004; Clark *et al.*, 2010]. The weak plateau lithosphere squeezed  
521 against the strong Tarim basin / craton in the north, represented by the back wall of the  
522 box in our experiments, can deform early far from the collision zone. The Himalayan  
523 plate boundary is complex with transpressive deformation along the Karakorum fault,

524 the suture and the Jiali fault, which is connected with north-south striking grabens from  
525 the west – central part of the plateau (Fig). Right-lateral strike-slip shearing (early to  
526 mid-Miocene) and east-west extension (mid-Miocene) are very close in age and may  
527 have been coeval in east and central Tibet [Murphy *et al.*, 2002, 2010; Taylor *et al.*,  
528 2003; Searle *et al.*, 2011 and references therein]. Our experiments reproduce very well  
529 this pattern and are consistent with previous experiments [Ratschbacher *et al.*, 1991a]  
530 with the development of a large-scale transpressive fault at the boundary between craton  
531 and plateau lithospheres, coeval with the opening of conjugate grabens (Figures 6 and  
532 7). The grabens rotate clockwise to accommodate lateral escape but stay roughly  
533 parallel to each other and do not show changes in strike from west to east as in Tibet  
534 [Kapp and Gynn, 2004]. The plate boundary stays almost straight unlike the arcuate  
535 Himalaya bounded by syntaxes. This implies that processes not reproduced in the  
536 experiments and controlled by earlier oceanic subduction stages and/or the shape of  
537 Greater India [Ali and Atchinson, 2005; Replumaz *et al.*, 2010c; van Hinsbergen *et al.*,  
538 2011; Bajolet *et al.*, 2013] would be responsible specific features of the orogen such as  
539 (i) the Himalayan orocline and the variable strike of rifts potentially due to oroclinal  
540 bending [Ratschbacher *et al.*, 1994], (ii) the lateral variations in strain orientation along  
541 the orogenic front [Seeber and Pecher, 1998; Kapp and Gynn, 2004] and (iii)  
542 southward propagation of the orogenic front [Murphy and Copeland, 2005; Bajolet *et*  
543 *al.*, 2013]. In our models, the grabens are also restricted to the plate boundary area and  
544 within the cratonic lithosphere, and transpression is confined to the inner plateau  
545 (Figures 6 to 8), whereas central Tibet is under transtension [Andronicos *et al.*, 2007].  
546 The boundary between these domains is also more irregular in nature than in our  
547 experiments [e.g. Ratschbacher *et al.*, 2011]. Possibly because in our experiments the  
548 rheological contrast between the plateau and the craton localizes this boundary.

549 Moreover, the Tibetan plateau's width is variable (from ca. 400 km near the west  
550 syntaxe to 1000 km in its center) whereas it is constant in our experiments. In our 3D  
551 models, gravitational collapse is mainly accommodated by lower ductile flow, whilst it  
552 is also partially accommodated in the upper crust in Tibet by active grabens.  
553 Transtension is observed in the less deformed external part of the 3D models that rotates  
554 clockwise during escape (Figures 6 to 8). Experiments F2 and F3 (Figure 6 and 7) with  
555 a thin confining layer show large amount of escape as in east Tibet but limited rotation.  
556 Experiment F1 with a thick confining layer (Figure 8) reproduces well the overall  
557 rotation and deformation pattern of extruded SE Tibet between the Red River and  
558 Sagaing faults, but with a small amount of escape. This would confirm the  
559 heterogeneity in lithospheric strength east of Tibet, with an overall weak lateral foreland  
560 allowing eastward escape, but bearing a strong Sichuan basin resisting and redirecting  
561 lateral escape to the SE [Cook and Royden, 2008; Robert et al., 2010a].

562 If it is now well established that deformation is distributed within the Tibetan  
563 plateau, strain localization at depth is still debated, especially in eastern Tibet.  
564 Earthquakes distribution [Clark and Royden, 2000; Steck et al., 2001; Andronicos et al.,  
565 2007; Priestley et al., 2007] and geophysical imaging [Bai et al., 2010; Liu et al., 2014;  
566 Bao et al., 2015] suggests that 1) the mid/lower crust is heterogenous with weak regions  
567 (interconnected or not) and stronger ones, 2) some faults are rooted in the deep crust  
568 and channelize crustal flow, whereas others are restricted to the upper crust. In our  
569 experiments, the fact that the most external (escaped) part the models remains mostly  
570 undeformed and that silicone layers are homogeneous does not allow us to model  
571 complex flow patterns at depth and test the hypotheses mentioned above.

572

573 4. 2. *Transverse mass transfers at plateau edge*



574 Our experimental results help reconstruct a sequence of deformation at the contact  
575 between a hot and a cold lithosphere under ongoing convergence such as the Himalaya  
576 collision zone (Figure 11). Early shortening is absorbed dominantly by indentation of  
577 the hot lithosphere by the mantle layer of the cold lithosphere. In the weak lithosphere,  
578 ongoing convergence is accommodated by distributed thickening and by burial of upper  
579 crust by the formation of pop-downs [*Cagnard et al.*, 2006b]. Pop-downs are not  
580 observed in the cratonic lithosphere because strong lithospheric mantle prevents  
581 downward motion of crustal material. Instead, shortening is accommodated by  
582 thickening and pop-ups. Indentation at depth evolves into the subduction of the cratonic  
583 mantle beneath the weak lithosphere. Decoupling along the continental subduction  
584 enables overflow and later injection of the lower crust of the hot lithosphere into the  
585 orogenic wedge. Shortening of the cold lithosphere induces moderate crustal thickening  
586 and strain localization along foreland-verging thrusts rooted in the subduction shear  
587 zone. The shear zone accommodating back-shearing at the roof of the overflowing hot  
588 lower crust emerges as a retro-thrust at the suture. In other words, transverse advection  
589 of weak lithosphere lower crust produces indentation of the foreland crust by coeval  
590 activation of (1) retro-fold-and-thrust belt whose front coincides with the suture, and  
591 (2) a pro- (subduction) shear zone rooting in the crust-mantle boundary. The surface  
592 trace of the suture zone migrates towards the hinterland concomitantly with cratonward  
593 injection of lower crust and continental subduction. Interestingly, these features and  
594 kinematics are also produced in channel flow numerical experiments where the craton  
595 lower crust does not subduct with, and is decoupled from, the underlying lithospheric  
596 mantle and the trench is fixed [*Beaumont et al.*, 2004]. In numerical models with trench  
597 advance as in the India-Asia collision, the motion of the suture (pro-ward or retro-ward)  
598 depends on the trade-off between the subduction velocity and the denudation intensity

599 at the orogenic front. Our experiments do not simulate early stages of subduction and  
600 the cratonic upper crust is not forced to subduct beneath the plateau lithosphere as in  
601 numerical models, which may explain the migration of the surface trace of the suture  
602 toward the hinterland. However, the suture, branching on a lithospheric shear zone,  
603 controls underthrusting of the cratonic lithospheric mantle at a shallow angle and a fold-  
604 and-thrust belt develops at the lithospheres boundary. This configuration is similar to  
605 the India-Asia collision where Indian mantle underthrusts the Tibetan lithosphere over a  
606 large area [*Jimenez-Munt et al.*, 2008; *Li et al.*, 2008]. One may infer from the  
607 experiments that in case of efficient erosion at the orogenic front, the dome of lower  
608 plateau crust could be significantly exhumed. Such an exhumation would stop backward  
609 flow at the roof of the dome and may change the kinematics at the suture. Therefore, the  
610 trench-fixed dynamics reproduced in the experiments may be only transient and coeval  
611 with dome amplification and ascent, before trench-advance occurs in late collisional  
612 stages.

613 Keeping a nearly stationary flat Moho and topographic surface, the plateau crust  
614 shortens and thickens by preferential downward motions that are transformed into  
615 cratonward (i.e., transverse) extrusion of lower crust (Figure 11). The initiation and  
616 amplification mode, structure and kinematics of the lower crustal dome indenting the  
617 collisional wedge compare to those of hot fold nappes and may reflect early stages of a  
618 channel flow process. However, in contrast with fold nappes that are fed from below by  
619 upward extrusion of collisional wedge crust [*Merle and Guillier*, 1989; *Duretz et al.*,  
620 2011], our model implies feeding of the transversally extruding lower crust by  
621 downward burial of thickened plateau crust.

622 In channel flow models as set up by *Beaumont et al.* [2004], the shape and amplitude  
623 of cratonward flow are determined by the conditions at the plate boundary and the

624 denudation intensity at the orogenic front. Exhumation of lower crust is achieved for  
625 denudation rates of ca.  $1\text{ cm yr}^{-1}$  and a fixed shape of the subduction fault assuming a  
626 non-deformable upper mantle. These parameters ensure the formation of a large-scale  
627 channel in the mid-crust (injecting the craton over several hundreds of kilometers)  
628 unlike the structure observed in our models. The fact that no net exhumation of the  
629 dome takes place in our models requires either a change in the boundary conditions of  
630 the injection, or an additional phenomenon not modeled here and permitting the hot  
631 lower crust to reach the surface. An increase of mechanical coupling between the two  
632 lithospheres will inhibit subduction and transversal flow. This should also favor the  
633 nucleation of a thrust ramp below the advancing dome, which would form a fault bent  
634 fold involving the dome, thereby enhancing focused erosion and ultimately exhumation  
635 of the dome (Figure 11). No structure comparable to the South Tibetan Detachment  
636 (STD) is formed during our experiments, most probably because the exhumation of the  
637 dome is not complete. However, toppling of the backlimb of the dome on the ramp  
638 would turn the retro-thrust system accompanying transversal injection into a hinterland-  
639 dipping detachment system comparable to the STD (Figure 11, e.g., *Godin et al.*, 2011).  
640 Whatever the mechanism controlling the kinematics of this detachment (gravitational  
641 collapse or extension-assisted mountain building), the formation of a crustal ramp and  
642 its consequences could set favorable conditions to establish channel flow as envisaged  
643 by *Beaumont et al.* [2001, 2004]. In the scenario exposed above, back thrusts at the rear  
644 of the exhumed lower crust (former dome) may either be fossil (abandoned after  
645 activation of the detachment) or reactivated by gravity-driven slip along the detachment.  
646 Reactivation of the Himalayan suture along back-thrusts of post-early Oligocene age  
647 [*Masclé et al.*, 1986; *Yin et al.*, 1994; *Aldsorf et al.*, 1998] may indicate the emergence  
648 of the retro fold-and-thrust belt produced experimentally.

649

650 4. 3. *Three-dimensional mass balance: transversal vs. longitudinal crustal flow*

651 The results of the two sets of experiments suggest that three-dimensional mass  
652 redistribution takes place by combining transversal injection of plateau lower crust into  
653 the frontal foreland as modeled by *Beaumont et al.* [2001], and lateral flow of the weak  
654 lithosphere as proposed by *Royden et al.* [1997] (Figure 11). The relative magnitude of  
655 the two processes is controlled by a balance between the degree of mechanical coupling  
656 along the craton/plateau boundary and by lateral forces resulting from the resistance and  
657 buoyancy of the lateral foreland. We observe that lateral escape observed in our 3D  
658 experiments prevents significant continental underthrusting and concomitant injection  
659 of plateau lower crust into the orogenic wedge. This implies that transversal  
660 (injection/subduction) and longitudinal (escape) mass transfers may not coexist with  
661 comparable fluxes during the entire evolution of the orogenic system. For an unstable  
662 lithosphere, gravity forces can be accommodated by faulting in the upper crust and/or  
663 by ductile flow at depth. Stages of transversal-dominated and escape-dominated flow  
664 may alternate depending on the boundary conditions at the orogenic front and lateral  
665 boundary. In the following, we propose a typical scenario for the three dimensional  
666 evolution of a collision zone between a cratonic and a weak lithosphere.

667 The strength of the lateral foreland and forces arising from density contrasts on the  
668 lateral boundary of the converging system primarily control the mode of lateral escape  
669 of the weak lithosphere. As in our experiments, during the early stages of collision, a  
670 weak lateral foreland and a large Argand number of the hot lithosphere enhance lateral  
671 collapse-driven escape even for low values of shortening-induced thickening  
672 (configuration of F2 experiment). A lateral flow regime is installed. In nature, lateral  
673 escape could also be favored by lateral tension forces arising for instance from

674 subduction occurring close to the lateral boundary of the collision zone [e.g.,  
675 *Tapponnier et al.*, 1986; *Ratschbacher et al.*, 1991b; *Fournier et al.*, 2004; *Schellart*  
676 *and Lister*, 2005; *Faccenna et al.*, 2006]. Strength built-up in the lateral foreland as a  
677 consequence of escape-driven tectonic thickening may reach a threshold, triggering  
678 thickening of the weak lithosphere and slow forced tectonic extrusion (F1 experiment  
679 configuration). At this stage, decoupling in the collision zone favors a transversal flow  
680 regime driven by transformation of plateau overthickening into cratonward expulsion of  
681 lower crust (Figures 4, 5 and 11).

682 The transversal flow regime is maintained as long as the stiff lateral foreland limits  
683 collapse. During this period, gravity forces are accommodated by cratonward injection  
684 of plateau lower crust between a thrust and a detachment, as the High Himalayan  
685 Crystalline, whose exhumation was driven by coeval and opposed shearing along the  
686 MCT and STD between ca. 25 and 13 Ma. In details, the exhumation process was  
687 probably more complex, not fully synchronous along the range, and likely of lesser  
688 amplitude than that simulated in *Beaumont et al.* [2004] and in our experiments,  
689 especially considering the lateral structural / rheological heterogeneity of the lower crust  
690 [*Long and McQuarrie*, 2010; *Rey et al.*, 2010; *Kellett and Grujic*, 2012].

691 A return to a lateral flow regime would be permitted if a change in the configuration  
692 of the orogenic system would again permit collapse-driven lateral escape. Such a  
693 change may result from a threshold in the gravitational potential of the weak lithosphere  
694 with respect to its lateral foreland and/or from a drop in the degree of coupling at the  
695 craton/plateau boundary. Such a process may have resulted from break-off of the Indian  
696 subducting slab inferred to propagate from west to east between 25 and 10 Ma  
697 [*Replumaz et al.*, 2010b; *Stearns et al.*, 2015]. Slab break-off may largely increase the  
698 elevation of the plateau [e.g., *Molnar et al.*, 1993], its Argand number compared to its

699 lateral foreland and, in turn, favor lateral escape. The lateral flow regime would be  
700 installed at the end of the break-off or once the process is completed. Initiation of a  
701 subduction at the lateral boundary could also enhance lateral escape.

702 A reorganization of the frontal continental subduction fault system may also cause  
703 for switching from a transversal to a lateral orogenic flow regime. Nucleation and  
704 activation of a crustal ramp in the footwall of the transversally overflowing lower crust  
705 (see above) could trigger an increase in the inter-plate coupling, an increase in  
706 topography, and therefore favor collapse-driven lateral escape. Abandonment of the  
707 MCT around 13 Ma and activation of the Main Boundary Thrust (MBT) could have  
708 triggered such a change.

709 The switch from a transversal to a lateral orogenic flow regime is exemplified in the  
710 Ama Drime Massif of the High Himalayan Crystalline, which has been exhumed at the  
711 southern edge of the Tibetan plateau between the MCT and the STD. Exhumation of the  
712 massif started at ca. 30 Ma along the STD with N-S extension, and the tectonic regime  
713 then switched to E-W extension activating the NS-striking normal shear zones bounding  
714 the massif at ca. 12-13 Ma [Jessup *et al.*, 2008; Cottle *et al.*, 2009; Kali *et al.*, 2010].  
715 The age of ~ 13 Ma is consistent with the onset of lateral extension in the Tibetan  
716 plateau estimated between 16 and 8 Ma [Armijo *et al.*, 1986; Styron *et al.*, 2015] and  
717 attributed to lateral collapse [e.g., Coleman and Hodges, 1995; Williams *et al.*, 2001].  
718 Lateral collapse therefore postdates the main episode of transversal flow of the High  
719 Himalaya Crystalline between 25 and 15 Ma [Burg *et al.*, 1984; Hubbard and Harrison,  
720 1989; Hodges *et al.*, 1992]. The formation of the MBT in the footwall of the MCT  
721 around 13 – 12 Ma [e.g., Kali *et al.*, 2010] would have provided the necessary  
722 conditions for a change from a transversal to longitudinal flow regime in the Himalaya-  
723 Tibet orogenic system. This change may have been accompanied by a transient flow

724 regime during which the extruding lower crust of the High Himalaya Crystalline  
725 recorded both transversal flow at depth and lateral flow at its roof [*Burg et al.*, 1984;  
726 *Brun et al.*, 1985; *Gapais et al.*, 1992; *Beaumont et al.*, 2001; *Murphy and Copeland*,  
727 2005]. The onset of normal faulting is also documented at ca. 13 Ma in other Himalayan  
728 domes [e.g. *Murphy et al.*, 2002; *Languille et al.*, 2014] and in Tibet [e.g. *Armijo et al.*,  
729 1986; *Blisniuk et al.*, 2001; *Styron et al.*, 2015]. Rifts and extensional focal mechanisms  
730 are more numerous in south than in central or north Tibet [*Copley et al.*, 2011]. We  
731 propose that after 13 Ma, gravitational collapse was mainly accommodated by brittle  
732 faulting in the upper crust in south Tibet and by ductile lateral flow in northern Tibet.  
733 This can be understood considering that 1) lateral flow in south Tibet is partially  
734 blocked by the east Himalayan syntaxis, 2) southern Tibet is underthrust by India,  
735 herewith increasing its overall strength. In our experiments, grabens are indeed more  
736 developed in the plateau lithosphere for overall stronger ductile layers (Figures 6 and 7).  
737 This would be consistent with recent studies highlighting the importance of India  
738 underthrusting on rifting in Tibet [*Copley et al.*, 2011; *Ratschbacher et al.*, 2011; *Styron*  
739 *et al.*, 2015]. If orogen-parallel extension is partly accommodated by brittle faulting in  
740 northern Tibet, the main mechanism is ductile lateral flow along strike-slip faults, as in  
741 our 3D experiments (Figure 6 to 8). In areas where the lithosphere has regained a stable  
742 thickness, lateral escape could continue, driven by forced tectonic extrusion.

743

## 744 **5. Conclusions**

745 The present work suggests that paired orogenic plateaus – collisional wedges may  
746 undergo two distinct syn-convergence flow regimes governed by the balance between  
747 the gravity potential and the strength of the plateau crust, and the resistance of its lateral  
748 foreland. A first possible regime, accretion dominated, is characterized by transversal

749 injection of plateau lower crust into the collisional wedge as a result of confinement of  
750 the plateau by an increasingly stiffer lateral foreland. In this regime, transversal  
751 injection is driven by downward thickening of the plateau crust that is forcedly extruded  
752 into the orogenic wedge. The second orogenic flow regime is characterized by collapse-  
753 driven lateral escape of the plateau as a consequence of increasing inter-plate coupling  
754 in the collision zone, which increases the gravity potential of the plateau with respect to  
755 the resistance of its lateral foreland. During collapse-driven lateral escape, a large  
756 proportion of convergence-induced thickening of the plateau and the top of the  
757 collisional wedge is transformed into lateral constrictional flow and extension.

758

#### 759 **Acknowledgments**

760 This work was carried out at the experimental tectonic laboratory in Rennes. We  
761 thank N. Durrieu, Y. Daoudene and M. Philippon for assistance in the lab and C.  
762 Cavaré-Hester for finalizing figures 9 and 11. The paper benefited from a constructive  
763 review by W. Schellart and an anonymous reviewer that helped improved an earlier  
764 version of the manuscript.

765

#### 766 **Appendix A. Calculation of the Argand number**

767 The Argand number allows the quantification of the stability of the lithosphere. It is  
768 expressed as the ratio between body forces that favor the gravitational collapse of the  
769 lithosphere, and tectonic forces that oppose it [*England and McKenzie*, 1982;  
770 *Houseman and England*, 1986]:

$$771 \text{Ar} = F_B/F_T \quad (1)$$



772 For our models, the buoyancy force may be calculated as the difference between the  
773 gravitational potential energy of the lithosphere (cratonic or plateau type) integrated  
774 over depth and that of the lateral foreland (confining silicone)

$$775 F_B = \int_{\text{surface}}^z (\rho(z) z g)_{\text{collision}} dz - \int_{\text{surface}}^z (\rho(z) z g)_{\text{lateral}} dz \quad (2)$$

776 Given the collapse regime operating in the models with lateral escape, the tectonic force  
777 is calculated assuming a vertical  $\sigma_1$  as the sum of tectonics forces necessary to stretch  
778 the brittle and ductile layers

$$779 F_T = F_{T\text{brittle}} + F_{T\text{ductile}} \quad (3)$$

780 with

$$781 F_{T\text{brittle}} = 1/3 g \rho_{BC} h_{BC}^2 \quad (4)$$

$$782 F_{T\text{ductile}} = 2 \eta h d\epsilon/dt \quad (5)$$

783 where  $g$  is the gravity,  $\rho_{BC}$  and  $h_{BC}$  the density and thickness of the sand layer,  $\eta$  and  $h$   
784 the viscosity and thickness of the silicone layer, and  $d\epsilon/dt$  the experimental strain rate.

785 The strain rate  $d\epsilon/dt$  is calculated as

$$786 d\epsilon/dt = V/W \quad (6)$$

787 where  $V$  is the shortening velocity and  $W$  the length of the model in the shortening-  
788 parallel direction. Thicknesses of layers at the end of each experiment were measured  
789 on the most internal and most external cross-sections; whereas those at the beginning of  
790 the experiments are known from model building. This allows us to quantify the stability  
791 of the lithospheres at the beginning and at the end of the experiments. Argand numbers  
792 are given in Table 4.

793

794

795 **Appendix B. Quantification of deformation**

796 Following the method proposed by *Cruden et al.* (2006), a three-dimensional finite  
 797 strain analysis has been performed by measuring deformation of the ductile layers on  
 798 each cross-section of the models. For this purpose, the x direction is defined as the  
 799 direction of convergence, y as the direction of lateral escape (orogen parallel), z as the  
 800 vertical direction. Initial and final measured lengths ( $L_0$  and  $L$ ) and thicknesses ( $T_0$  and  
 801  $T$ ) of the ductile layers give the principal strains in x and z directions with the relation

$$802 \lambda_x = (L/L_0)^2 = (1+\epsilon_x)^2 \text{ and } \lambda_z = (T/T_0)^2 = (1+\epsilon_z)^2 \quad (1)$$

803 The principal strain in the direction of lateral escape (y) is calculated from the change in  
 804 cross-sectional area can be expressed as

$$805 \lambda_y = (A_0/A)^2 = (1+\epsilon_y)^2 \quad (2)$$

806 where  $A_0$  and  $A$  are the initial and final area respectively. Flinn's K parameter defining  
 807 the aspect ratio of the strain ellipsoids has been calculated as

$$808 K = (\lambda_1/\lambda_2 - 1)/(\lambda_2/\lambda_3 - 1) \quad (3)$$

809  $\lambda_1, \lambda_2$  and  $\lambda_3$  being the maximal, intermediate and minimum principal axes of the strain  
 810 ellipsoid, respectively. Strain intensity for each ellipsoid is estimated by  $\epsilon_s$  [*Nadai,*

811 1950], defined as

$$812 \epsilon_s = (\sqrt{3}/2) * \gamma_0 \quad (4)$$

813 with

$$814 \gamma_0 = 2/3 * \{[\ln(\lambda_1/\lambda_2)]^2 + [\ln(\lambda_2/\lambda_3)]^2 + [\ln(\lambda_3/\lambda_1)]^2\}^{1/2} \quad (5)$$

815

816

817 **Note:** <sup>1</sup>. See supplementary material comprising photos, descriptions of the experiments

818 that were not detailed in the paper and tables containing strain and lateral escape

819 measurement data.

820

821 **References**

- 822 Alsdorf, D., L. Brown, K. D. Nelson, Y. Makovsky, S. Klemperer, and W. J. Zhao (1998),  
823 Crustal deformation of the Lhasa terrane, Tibet plateau from Project INDEPTH deep  
824 seismic reflection profiles, *Tectonics*, 17(4), 501-519, doi:10.1029/98TC01315.
- 825 Andronicos, C. L., A. A. Velasco, and J. M. Hurtado (2007), Large-scale deformation in  
826 the India-Asia collision constrained by earthquakes and topography, *Terra Nova*,  
827 19, 105–119, doi:10.1111/j.1365-3121.2006.00714.x.
- 828 Armijo, R., P. Tapponnier, J. L. Mercier and H. Tong-Lin (1986), Quaternary extension  
829 in Southern Tibet: Field observations and tectonic implications, *J. Geophys. Res.*,  
830 91, B14, doi: 10.1029/JB091iB14p13803.
- 831 Bai, D. H., M. J. Unsworth, M. A. Meju, X. B. Ma, J. W. Teng, X. R. Kong, Y. Sun, L. F.  
832 Wang, C. S. Jiang, C. P. Zhao, P. F. Xiao, and M. Liu (2010), Crustal deformation of the  
833 eastern Tibetan plateau revealed by magnetotelluric imaging, *Nature Geoscience*, 3(5),  
834 358-362, doi:10.1038/Ngeo830.
- 835 Bajolet, F., A. Replumaz, and R. Laine (2013), Orocline and syntaxes formation during  
836 subduction and collision, *Tectonics*, 32(5), 1529-1546, doi:10.1002/Tect.20087.
- 837 Bao, X., X. Sun, M. Xu, Eaton D. W., X. Song, L. Wang, Z. Ding, N. Mi, H. Li, D. Yu, Z.  
838 Huang, and P. Wang (2015), Two crustal low-velocity channels beneath SE Tibet revealed  
839 by joint inversion of Rayleigh wave dispersion and receiver functions, *Earth Planet. Sci.*  
840 *Lett.*, 415, 16-24, doi:10.1016/j.epsl.2015.01.020.
- 841 Beaumont, C., R. A. Jamieson, M. H. Nguyen, and B. Lee (2001), Himalayan tectonics  
842 explained by extrusion of a low-viscosity crustal channel coupled to focused surface  
843 denudation, *Nature*, 414, 738-742, doi:10.1038/414738a.
- 844 Beaumont, C., R. A. Jamieson, M. H. Nguyen, and S. Medvedev (2004), Crustal channel flows:  
845 1. Numerical models with applications to the tectonics of the Himalayan-Tibetan orogen, *J.*

846 *Geophys. Res.*, 109, B06406, doi:10.1029/2003JB002809.

847 Bird, P. (1991), Lateral Extrusion of Lower Crust from under High Topography, in the Isostatic  
848 Limit, *J. Geophys. Res.*, 96(B6), 10275-10286, doi: 10.1029/91JB00370.

849 Blisniuk, P. M., B. R. Hacker, J. Glodny, L. Ratschbacher, S. W. Bi, Z. H. Wu, M. O.  
850 McWilliams, and A. Calvert (2001), Normal faulting in central Tibet since at least 13.5  
851 Myr ago, *Nature*, 412(6847), 628-632, doi:10.1038/35088045.

852 Brun, J. P., J. P. Burg, and C. G. Ming (1985), Strain Trajectories above the Main Central  
853 Thrust (Himalaya) in Southern Tibet, *Nature*, 313, 388-390, doi:10.1038/313388a0.

854 Brun, J. P. (2002), Deformation of the continental lithosphere: insights from brittle–ductile  
855 model, in *Deformation Mechanisms, Rheology and Tectonics: Current Status and Future  
856 Perspectives*, edited by S. De Meers, M. R. Drury, J. H. P. De Bresser and G. M. Pennock,  
857 *Geol. Soc. Spec. Publ.*, 200, 355-370, doi: 10.1144/GSL.SP.2001.200.01.20.

858 Burg, J. P., M. Brunel, D. Gapais, G. M. Chen, and G. H. Liu (1984), Deformation of  
859 Leucogranites of the Crystalline Main Central Sheet in Southern Tibet (China), *J. Struct.  
860 Geol.*, 6(5), 535-542, doi:10.1016/0191-8141(84)90063-4.

861 Cagnard, F., N. Durrieu, D. Gapais, J. P. Brun, and C. Ehlers (2006a), Crustal thickening and  
862 lateral flow during compression of hot lithospheres, with particular reference to  
863 Precambrian times, *Terra Nova*, 18(1), 72-78, doi: 10.1111/j.1365-3121.2005.00665.x.

864 Cagnard, F., J. P. Brun, and D. Gapais (2006b), Modes of thickening of analogue weak  
865 lithospheres, *Tectonophysics*, 421(1-2), 145-160, doi:10.1016/j.tecto.2006.04.016.

866 Chardon, D., D. Gapais, and F. Cagnard (2009), Flow of ultra-hot orogens: A view from the  
867 Precambrian, clues for the Phanerozoic, *Tectonophysics*, 477(3-4), 105-118,  
868 doi:10.1016/j.tecto.2009.03.008.

869 Chardon, D., M. Jayananda, and J. •J. Peucat (2011), Lateral constrictional flow of hot  
870 orogenic crust: Insights from the Neoproterozoic of south India, geological and

871 geophysical implications for orogenic plateaux, *Geochem. Geophys. Geosyst.*, 12,  
872 Q02005, doi:10.1029/2010GC003398.

873 Clark, M. K., K. A. Farley, D. W. Zheng, Z. C. Wang, and A. R. Duvall (2010), Early Cenozoic  
874 faulting of the northern Tibetan Plateau margin from apatite (U-Th)/He ages, *Earth Planet.*  
875 *Sci. Lett.*, 296(1-2), 78-88, doi:10.1016/J.Epsl.2010.04.051.

876 Clark, M. K., and L. H. Royden (2000), Topographic ooze: Building the eastern margin of  
877 Tibet by lower crustal flow, *Geology*, 28(8), 703-706, doi:10.1130/0091-  
878 7613(2000)28<703:TOBTEM>2.0.CO;2.

879 Coleman, M.E., and K.V. Hodges, 1995, Evidence for Tibetan plateau uplift before 14  
880 m.y. ago from a new minimum age for east-west extension, *Nature*, 374, 49–52,  
881 doi:10.1038/374049a0.

882 Cook, K. L., and L. H. Royden (2008), The role of crustal strength variations in shaping  
883 orogenic plateaus, with application to Tibet, *J. Geophys. Res.*, 113(B8), B08407,  
884 doi:10.1029/2007JB005457.

885 Copley, A., J. P. Avouac, and B. P. Wernicke (2011), Evidence for mechanical coupling and  
886 strong Indian lower crust beneath southern Tibet, *Nature*, 472(7341), 79-81,  
887 doi:10.1038/Nature09926.

888 Cottle, J. M., M. J. Jessup, D. L. Newell, M. S. A. Horstwood, S. R. Noble, R. R. Parrish, D. J.  
889 Waters, and M. P. Searle (2009), Geochronology of granulitized eclogite from the Ama  
890 Drime Massif: Implications for the tectonic evolution of the South Tibetan Himalaya,  
891 *Tectonics*, 28, TC1002, doi:10.1029/2008TC002256.

892 Cruden, A. R., M. H. B. Nasser, and R. Pysklywec (2006), Surface topography and  
893 internal strain variation in wide hot orogens from three-dimensional analogue and  
894 two-dimensional numerical vice models, in *Analogue and Numerical Modelling of*  
895 *Crustal-Scale Processes*, edited by S. J. H. Buiter and G. Schreurs, *Geol. Soc. Spec.*

896 *Publ.*, 253, 79–104, doi:10.1144/GSL.SP.2006.253.01.04.

897 Davy, P., and Cobbold P. R. (1988), Indentation tectonics in nature and experiment, 1.  
898 Experiments scaled for gravity, *Bulletin of the Geological Institutions of Uppsala*,  
899 *New Series*, 14, 129-141.

900 Davy, P., and P. R. Cobbold (1991), Experiments on Shortening of a 4-Layer Model of the  
901 Continental Lithosphere, *Tectonophysics*, 188(1-2), 1-25, doi:10.1016/0040-  
902 1951(91)90311-F.

903 Dewey, J.F. (1988), Extensional collapse or orogens, *Tectonics*, 7(6), 1123-1139,  
904 doi:10.1029/TC007i006p01123.

905 Duretz, T., B. J. P. Kaus, K. Schulmann, D. Gapais, and J.-J. Kermarrec (2011),  
906 Indentation as an extrusion mechanism of lower crustal rocks: Insight from  
907 analogue and numerical modelling, application to the Eastern Bohemian Massif,  
908 *Lithos*, 124(1-2), 158-168, doi:10.1016/j.lithos.2020.10.013.

909 England, P., and G. Houseman (1989), Extension during Continental Convergence, with  
910 Application to the Tibetan Plateau, *J. Geophys. Res.*, 94(B12), 17,561-17,579,  
911 doi:10.1029/JB094iB12p17561.

912 England, P., and D. McKenzie (1982), A thin viscous sheet model for continental  
913 deformation, *Geophys. J. R. Astron. Soc.*, 70, 295–321, doi:10.1111/j.1365-  
914 246X.1982.tb04969.x.

915 England, P. C., and A. B. Thompson (1984), Pressure temperature time paths of  
916 regional metamorphism. 1. Heat transfer during the evolution of regions of  
917 thickened continental crust, *J. Petrol.*, 25(4), 894–928,  
918 doi:10.1093/petrology/25.4.894.

919 Faccenna, C., O. Bellier, J. Martinod, C. Piromallo and V. Regard (2006), Slab  
920 detachment beneath eastern Anatolia: A possible cause for the formation of the

921 North Anatolian fault, *Earth Planet. Sci. Lett.*, 242, 85-97, doi:  
922 10.1016/j.epsl.2005.11.046.

923 Fournier, M., L. Jolivet, P., Davy, J. C., Thomas, (2004), Backarc extension and  
924 collision: an experimental approach to the tectonics of Asia, *Geoph. J. Int.*, 157(2),  
925 871-889, doi: 10.1111/j.1365-246X.2004.02223.x.

926 Gapais, D., A. Pécher, E. Gilbert, and M. Ballevre (1992), Synconvergence Spreading  
927 of the Higher Himalaya Crystalline in Ladakh, *Tectonics*, 11(5), 1045-1056, doi:  
928 10.1029/92TC00819.

929 Godin, L., C. Yakymchuk, and L. B. Harris (2011), Himalayan hinterland-verging  
930 superstructure folds related to foreland-directed infrastructure ductile flow: Insights from  
931 centrifuge analogue modelling, *J. Struct. Geol.*, 33(3), 329-342,  
932 doi:10.1016/J.Jsg.2010.09.005.

933 Grujic, D., M. Casey, C. Davidson, L. S. Hollister, R. Kundig, T. Pavlis, and S. Schmid (1996),  
934 Ductile extrusion of the Higher Himalayan Crystalline in Bhutan: Evidence from quartz  
935 microfabrics, *Tectonophysics*, 260(1-3), 21-43, doi:10.1016/0040-1951(96)00074-1.

936 Hodges, K. V., R. R. Parrish, T. B. Housh, D. R. Lux, B. C. Burchfiel, L. H. Royden, and Z.  
937 Chen (1992), Simultaneous Miocene Extension and Shortening in the Himalayan Orogen,  
938 *Science*, 258, 1,466-1,470, doi:10.1126/science.258.5087.1466.

939 Holt, W. E. (2000), Correlated crust and mantle strain fields in Tibet, *Geology*, 28, 67–  
940 70, doi:10.1130/0091-7613(2000)28<67:CCAMSF>2.0.CO;2.

941 Houseman, G., and P. England (1986), Finite strain calculations of continental  
942 deformation 1. Method and general results for convergent zones. *J. Geophys. Res.*,  
943 91(B3), 3,651–3,663, doi:10.1029/JB091iB03p03651.

944 Hubbard, M. S., and T. M. Harrison (1989), Ar-40/Ar-39 Age Constraints on Deformation and  
945 Metamorphism in the Main Central Thrust Zone and Tibetan Slab, Eastern Nepal

946 Himalaya, *Tectonics*, 8(4), 865-880, doi:10.1029/TC008i004p00865.

947 Jessup, M. J., D. L. Newell, J. M. Cottle, A. L. Berger, and J. A. Spotila (2008), Orogen-  
948 parallel extension and exhumation enhanced by denudation in the trans-Himalayan Arun  
949 River gorge, Ama Drime Massif, Tibet-Nepal, *Geology*, 36(7), 587-590,  
950 doi:10.1130/G24722A.1.

951 Jimenez-Munt, I., M., Fernandez, J., Verges, J. P., Platt (2008), Lithosphere structure  
952 underneath the Tibetan Plateau inferred from elevation, gravity and geoid  
953 anomalies, *Earth Planet. Sci. Lett.*, 267(1-2), 276-289,  
954 doi:10.1016/j.epsl.2007.11.045.

955 Kali, E., P. H. Leloup, N. Arnaud, G. Maheo, D. Y. Liu, E. Boutonnet, J. Van der  
956 Woerd, X. H. Liu, L. Z. Jing, and H. B. Li (2010), Exhumation history of the  
957 deepest central Himalayan rocks, Ama Drime range: Key pressure-temperature-  
958 deformation-time constraints on orogenic models, *Tectonics*, 29, TC2014,  
959 doi:10.1029/2009TC002551.

960 Kapp, P., and J. H. Guynn (2004), Indian punch rifts Tibet, *Geology*, 32(11), 993-996,  
961 doi:10.1130/G20689.1.

962 Kellett, D. A., and D. Grujic (2012), New insight into the South Tibetan detachment system:  
963 Not a single progressive deformation, *Tectonics*, 31, TC2007, doi:10.1029/2011tc002957.

964 Langille, J. M., M. J. Jessup, J. Cottle, and T. Ahmad (2014), Kinematic and thermal studies of  
965 the Leo Pargil Dome: Implications for synconvergent extension in the NW Indian  
966 Himalaya, *Tectonics*, 33(9), 1766-1786, doi:10.1002/2014tc003593.

967 Li, C., R. D. Van der Hilst, A. S. Meltzer, and E. R. Engdahl (2008), Subduction of the  
968 Indian lithosphere beneath the Tibetan Plateau and Burma, *Earth Planet. Sci. Lett.*,  
969 274(1-2), 157-168, doi:10.1016/j.epsl.2008.07.016.

970 Liu, Q. Y., R. D. van der Hilst, Y. Li, H. J. Yao, J. H. Chen, B. Guo, S. H. Qi, J. Wang, H.



971 Huang, and S. C. Li (2014), Eastward expansion of the Tibetan Plateau by crustal flow and  
972 strain partitioning across faults, *Nature Geoscience*, 7(5), 361-365, doi:10.1038/Ngeo2130.

973 Lohrmann, J., N. Kukowski, J. Adam, and O. Oncken (2003), The impact of analogue material  
974 properties on the geometry, kinematics, and dynamics of convergent sand wedges, *J.*  
975 *Struct. Geol.*, 25(10), 1691-1711, doi:Pii S0191-8141(03)00005-1

976 Loiselet, C., L. Husson and J. Braun (2009), From longitudinal slab curvature to slab  
977 rheology, *Geology*, 37(8), 747-750, doi:10.1130/G30052A.

978 Long, S., and N. McQuarrie (2010), Placing limits on channel flow: Insights from the Bhutan  
979 Himalaya, *Earth Planet Sci. Lett.*, 290(3-4), 375-390, doi:10.1016/J.Epsl.2009.12.033.

980 Mascle, G., G. Hérail, T. Van Haver, and B. Delcaillau (1986), Structure et évolution  
981 des bassins d'épissure et de périsuture liés à la chaîne himalayenne, *Bull. Centre*  
982 *Rech. Explor.-Prod. Elf Aquitaine*, 10, 182-203.

983 Merle, O. and B. Guillier (1989), The building of the Central Swiss Alps: an  
984 experimental approach, *Tectonophysics*, 165, 41-56, doi:10.1016/0040-  
985 1951(89)90034-6.

986 Merle, O. and D. Gapais (1997), Strains within thrust-wrench zones, *J. Struct. Geol.*,  
987 19(7), 1011-1014, doi:10.1016/S0191-8141(97)00027-8.

988 Molnar, P., P. England, and J. Martinod (1993), Mantle Dynamics, Uplift of the Tibetan  
989 Plateau, and the Indian Monsoon, *Reviews of Geophysics*, 31(4), 357-396,  
990 doi:10.1029/93RG02030.

991 Murphy, M. A., A. Yin, P. Kapp, T. M. Harrison, C. E. Manning, F. J. Ryerson, L. Ding, and J.  
992 H. Guo (2002), Structural evolution of the Gurla Mandhata detachment system, southwest  
993 Tibet: Implications for the eastward extent of the Karakoram fault system, *Geol. Soc. Am.*  
994 *Bull.*, 114(4), 428-447, doi:10.1130/0016-7606(2002)114<0428:Seotgm>2.0.Co;2.

995 Murphy, M. A., and P. Copeland (2005), Transtensional deformation in the central  
996 Himalaya and its role in accommodating growth of the Himalayan orogen,  
997 *Tectonics*, 24, TC4012, doi:10.1029/2004TC001659.

998 Murphy, M. A., V. Sanchez, and M. H. Taylor (2010), Syncollisional extension along the  
999 India-Asia suture zone, south-central Tibet: Implications for crustal deformation of Tibet,  
1000 *Earth Planet. Sci. Lett.*, 290(3-4), 233-243, doi:10.1016/J.Epsl.2009.11.046.

1001 Nadai, A. (1950), *Theory of Flow and Fracture of Solids*, McGraw-Hill, New York, 705  
1002 pp.

1003 Priestley, K., J. Jackson, and D. McKenzie (2007), Lithospheric structure and deep earthquakes  
1004 beneath India, the Himalaya and southern Tibet, *Geophys. J. Int.*, 172(1), 345-362,  
1005 doi:10.1111/j.1365-246X.2007.03636.x.

1006 Ratschbacher, L., O. Merle, P. Davy, and P. Cobbold (1991a), Lateral extrusion in the eastern  
1007 Alps, part 1: Boundary conditions and experiments scaled for gravity, *Tectonics*, 10(2),  
1008 245-256, doi:10.1029/90TC02622.

1009 Ratschbacher, L., W. Frisch, H-G. Linzer and O. Merle (1991b), Lateral extrusion in the  
1010 eastern Alps, part 2: Structural analysis, *Tectonics*, 10(2), 257-271,  
1011 doi:10.1029/90TC02623.

1012 Ratschbacher, L., W. Frisch, G. H. Liu, and C. S. Chen (1994), Distributed Deformation in  
1013 Southern and Western Tibet during and after the India-Asia Collision, *J. Geophys. Res.*,  
1014 99(B10), 19917-19945, doi:10.1029/94jb00932.

1015 Ratschbacher, L., I. Krumrei, M. Blumenwitz, M. Staiger, R. Gloaguen, B. V. Miller, S. D.  
1016 Samson, M. A. Edwards, and E. Appel (2011), Rifting and strike-slip shear in central Tibet  
1017 and the geometry, age and kinematics of upper crustal extension in Tibet, in *Growth and*  
1018 *Collapse of the Tibetan Plateau*, edited by Gloaguen, R., and L. Ratschbacher, *Geol. Soc.*  
1019 *Spec. Publ.*, 353, 127-163, doi:10.1144/SP353.8.

1020 Replumaz, A., A. M. Negredo, S. Guillot, P. van der Beek, and A. Villasenor (2010c),  
1021 Crustal mass budget and recycling during the India/Asia collision, *Tectonophysics*,  
1022 492(1-4), 99-107, doi:10.1016/j.tecto.2010.05.023.

1023 Replumaz, A., A. M. Negredo, A. Villasenor, and S. Guillot (2010b), Indian continental  
1024 subduction and slab break-off during Tertiary Collision, *Terra Nova*, 22(4), 290-296,  
1025 doi:10.1111/j.1365-3121.2010.00945.x.

1026 Rey, P. F., C. Teyssier, and D. L. Whitney (2010), Limit of channel flow in orogenic plateaux,  
1027 *Lithosphere*, 2(5), 328-332, doi:10.1130/L114.1.

1028 Riller, U., A. R. Cruden, D. Boutelier, and C. E. Schrank (2012), The causes of sinuous  
1029 crustal-scale deformation patterns in hot orogens: Evidence from scaled analogue  
1030 experiments and the southern Central Andes, *J. Struct. Geol.*, 37, 65-74,  
1031 doi:10.1016/j.jsg.2012.02.002.

1032 Robert, A., M. Pubellier, J. de Sigoyer, J. Vergne, A. Lahfid, R. Cattin, N. Findling, and J. Zhu  
1033 (2010), Structural and thermal characters of the Longmen Shan (Sichuan, China),  
1034 *Tectonophysics*, 491(1-4), 165-173, doi:10.1016/J.Tecto.2010.03.018.

1035 Royden, L. (1996), Coupling and decoupling of crust and mantle in convergent orogens:  
1036 Implications for strain partitioning in the crust, *J. Geophys. Res.*, 101(B8), 17,679-17,705,  
1037 doi:10.1029/96JB00951.

1038 Royden, L. H., B. C. Burchfiel, R. W. King, E. Wang, Z. L. Chen, F. Shen, and Y. P. Liu  
1039 (1997), Surface deformation and lower crustal flow in eastern Tibet, *Science*, 276(5313),  
1040 788-790, doi:10.1126/science.276.5313.788.

1041 Royden, L. H., B. C. Burchfiel, and R. D. van der Hilst (2008), The Geological Evolution of  
1042 the Tibetan Plateau, *Science*, 321, 1054-1058, doi:10.1126/science.1155371.

- 1043 Sandiford, M., and R. Powell (1991), Some remarks on high temperature•low•pressure  
1044 metamorphism in convergent orogens, *J. Metamorph. Geol.*, 9, 333–340,  
1045 doi:10.1111/j.1525-1314.1991.tb00527.x.
- 1046 Schellart, W. P. (2000), Shear test results for cohesion and friction coefficients for different  
1047 granular materials: scaling implications for their usage in analogue modelling,  
1048 *Tectonophysics*, 324(1-2), 1-16, doi:10.1016/S0040-1951(00)00111-6.
- 1049 Schellart, W. P. (2010), Evolution of Subduction Zone Curvature and its Dependence on the  
1050 Trench Velocity and the Slab to Upper Mantle Viscosity Ratio, *J. Geoph. Res.*, 115,  
1051 B11406, doi:10.1029/2009JB006643.
- 1052 Schellart, W. P., and G. S. Lister (2005), The role of the East Asian active margin in  
1053 widespread extensional and strike-slip deformation in East Asia, *J. Geol. Soc.*, 162, 959-  
1054 972, doi:10.1144/0016-764904-112.
- 1055 Searle, M. P., J. R. Elliott, R. J. Phillips, and S. L. Chung (2011), Crustal-lithospheric structure  
1056 and continental extrusion of Tibet, *J. Geol. Soc. London*, 168(3), 633-672,  
1057 doi:10.1144/0016-76492010-139.
- 1058 Seeber, L., and A. Pecher (1998), Strain partitioning along the Himalayan arc and the Nanga  
1059 Parbat antiform, *Geology*, 26(9), 791-794, doi:10.1130/0091-  
1060 7613(1998)026<0791:Spatha>2.3.Co;2.
- 1061 Shen, F., L. H. Royden, and B. C. Burchfiel (2001), Large-scale crustal deformation of the  
1062 Tibetan Plateau, *J. Geophys. Res.*, 106(B4), 6793-6816, doi:10.1029/2000jb900389.
- 1063 Steck, L. K., A. A. Velasco, A. H. Cogbill, and H. J. Patton (2001), Improving regional seismic  
1064 event location in China, *Pure App. Geoph.*, 158(1-2), 211-240, doi:10.1007/Pl00001157.
- 1065 Stearns, M. A., B. R. Hacker, Ratschbacher L., Rutte D., and A. R. C. Kylander-Clark (2015),  
1066 Titanite petrochronology of the Pamir gneiss domes: Implications for middle to deep crust  
1067 exhumation and titanite closure to Pb and Zr diffusion, *Tectonics*, 34, 784-802,

1068 doi:10.1002/2014TC003774.

1069 Styron, R., M. Taylor, and K. Sundell (2015), Accelerated extension of Tibet linked to the  
1070 northward underthrusting of Indian crust, *Nature Geoscience*, 8, 131-134,  
1071 doi:10.1038/NGEO2336.

1072 Tapponnier, P., G. Peltzer, A. Y. La Dain, R. Armijo, and P. Cobbold (1982),  
1073 Propagating extrusion tectonics in Asia: New insights from simple experiments  
1074 with plasticine, *Geology*, 10, 611-616, doi:10.1130/0091-  
1075 7613(1982)10<611:PETIAN>2.0.CO;2.

1076 Tapponnier, P., G. Peltzer, and R. Armijo (1986), On the mechanics of the collision  
1077 between India and Asia, *Geol. Soc. London Spec. Publ.*, 19, 113-157.

1078 Tapponnier, P., Z. Q. Xu, F. Roger, B. Meyer, N. Arnaud, G. Wittlinger, and J. S. Yang (2001),  
1079 Geology - Oblique stepwise rise and growth of the Tibet plateau, *Science*, 294(5547),  
1080 1671-1677, doi:10.1126/Science.105978.

1081 Taylor, M., A. Yin, F. J. Ryerson, P. Kapp, and L. Ding (2003), Conjugate strike-slip faulting  
1082 along the Bangong-Nujiang suture zone accommodates coeval east-west extension and  
1083 north-south shortening in the interior of the Tibetan Plateau, *Tectonics*, 22(4), 1044,  
1084 doi:10.1029/2002tc001361.

1085 Teysier, C. and B. Tikoff (1999), Fabric stability in oblique convergence and  
1086 divergence, *J. Struct. Geol.*, 21(8-9), 969-974, doi:10.1016/S0191-8141(99)00067-  
1087 X.

1088 Tikoff, B., R. Russo, C. Teysier, and A. Tommasi (2004), Mantle-driven deformation  
1089 of orogenic zones and clutch tectonic, in *Vertical Coupling and Uncoupling in the*  
1090 *Lithosphere*, edited by Grocott, J., K.J.W. McCaffrey, G. Taylor, and B. Tikoff,  
1091 *Geol. Soc. Spec. Publ.*, 227, 41-64, doi:10.1144/GSL.SP.2004.227.01.03.

1092 Vanderhaeghe, O., and C. Teysier (2001), Partial melting and flow of orogens,

1093 *Tectonophysics*, 342(3-4), 451-472, doi:10.1016/S0040-1951(01)00175-5.

1094 Weijermars, R., and H. Schmeling (1986), Scaling of Newtonian and non-Newtonian fluid  
1095 dynamics without inertia for quantitative modeling of rock flow due to gravity (including  
1096 the concept of rheological similarity), *Phys. Earth Planet. Int.*, 43, 316-330,  
1097 doi:10.1016/0031-9201(86)90021-X.

1098 Williams, H., S. Turner, S. Kelley, and N. Harris (2001), Age and composition of dikes  
1099 in Southern Tibet: New constraints on the timing of east-west extension and its  
1100 relationship to postcollisional volcanism, *Geology*, 29(4), 339–342,  
1101 doi:10.1130/0091-7613(2001)029<0339:AACODI>2.0.CO;2.

1102 Yin, A., T.M. Harrison, F.J. Ryerson, C. Wenji, W.S.F. Kidd, and P. Copeland (1994),  
1103 Tertiary structural evolution of the Gangdese thrust system, southeastern Tibet, *J.*  
1104 *Geophys. Res.*, 99, 18,175-18,201, doi:10.1029/94JB00504.

1105 Zhang, P. Z., Z. Shen, M. Wang, W. J. Gan, R. Burgmann, and P. Molnar (2004), Continuous  
1106 deformation of the Tibetan Plateau from global positioning system data, *Geology*, 32(9),  
1107 809-812, doi:10.1130/G20554.1.

1108

1109

1110

1111 **Table captions**

1112

1113 **Table 1.** Experimental parameters.

1114

1115 **Table 2.** Material properties for experiments laterally confined and with lateral escape.

1116

1117 **Table 3.** Differential stress of the ductile lithospheric layers for two different  
1118 experimental shortening rates.

1119

1120 **Table 4.** Strain intensities ( $\epsilon_s$ ) and Argand numbers ( $Ar$ ) calculated for experiments  
1121 with lateral escape. Argand numbers are given for initial and final configurations for the  
1122 most internal and external parts of the models. For experiment F1, lack of cross-sections  
1123 did not allow us to calculate the final  $Ar$  and  $\epsilon_s$ .

1124

1125

1126 **Figure captions**

1127

1128 **Figure 1.** a) Map of the main tectonic features of the Tibet-Himalaya orogenic system.

1129 Grabens and detachment faults are highlighted in red. F: fault; BNS: Bangong-Nujiang

1130 Suture; IT: Indus-Tsangpo; STD: South-Tibetan detachment; MCT: Main Central

1131 Thrust; MBT: Main Boundary Thrust; MFT: Main Frontal Thrust; LMSF:

1132 Longmenshan fault.

1133 b) Synthetic cross-section. BC: brittle crust; WLC: weak lower crust; CLM: cratonic

1134 lithospheric mantle.

1135

1136 **Figure 2.** Experimental setup. The graphs are strength profiles of both types of

1137 lithospheres. BC: brittle crust; DC: ductile crust; WLC: weak lithosphere lower crust;

1138 CLM: cratonic lithospheric mantle. Strength values are given in Table 3.

1139

1140 **Figure 3.** Top views and cross-sections of experiment C1 (see Tables 1 and 2 for

1141 parameters). Top views (top) show selected stages of fault surface pattern development,

1142 that on the right showing the configuration at the end of the experiment. On cross-

1143 sections, the numbers and percentages in bracket refer to the order of appearance and

1144 amount of shortening at which each fault formed, respectively. The lines of sections (5,

1145 3) are located on the last top view. WL: weak lithosphere; CL: cratonic lithosphere; d:

1146 dome (see text).

1147

1148 **Figure 4.** Cross-sections of experiments C2, C4, C5, C6, C7 and C8 (see Tables 1 and 2

1149 for parameters). White dashed lines represent originally horizontal passive markers in

1150 the ductile layers. Ductile lower crust in the weak lithosphere of experiments C7 and C8



1151 (TWLC in Tables 1 and 2) is initially doubly thickened. In experiment C7 (panel 4e),  
1152 the markers slightly lighter than the DC tend to localize the deformation. Moreover, the  
1153 model is deformed by post-experiment downwarping. See Figure 3 for caption.

1154

1155 **Figure 5.** Top views and cross-sections of experiment C3 (see Tables 1 and 2 for  
1156 parameters). White dashed lines represent passive markers in the ductile layers that  
1157 were originally horizontal. See Figure 3 for caption.

1158

1159 **Figure 6.** Top views and cross-sections of experiment F2 (see Tables 1 and 2 for  
1160 parameters, and Figure 3 for caption).

1161

1162 **Figure 7.** Top views and cross-sections of experiment F3 (see Tables 1 and 2 for  
1163 parameters, and Figure 3 for caption).

1164

1165 **Figure 8.** Top views of experiment F1 (see Tables 1 and 2 for parameters).

1166

1167 **Figure 9.** Summary of results of experiments with lateral escape. See text for further  
1168 explanations.

1169

1170 **Figure 10.** Relationships between lateral escape, thickening and thinning through time  
1171 for experiments with lateral escape. (a) to (c) Lateral escape of the model lithospheres  
1172 through time based on top view analysis. The portion of the area lost by the advancing  
1173 piston that is absorbed by lithospheric thickening results from the subtraction of the  
1174 total lithospheric area escaped to the area lost by advancing piston. (d) Evolution of the  
1175 thickening/escape ratio versus shortening.

1176

1177 **Figure 11.** Idealized view of two-stage orogenic flow mode at the edge of an orogenic

1178 plateau. See text for further explanations.

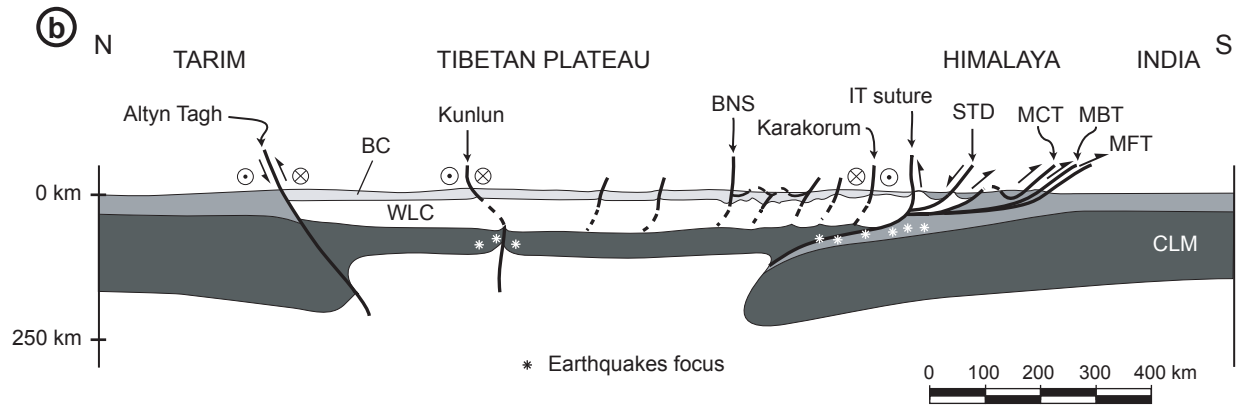
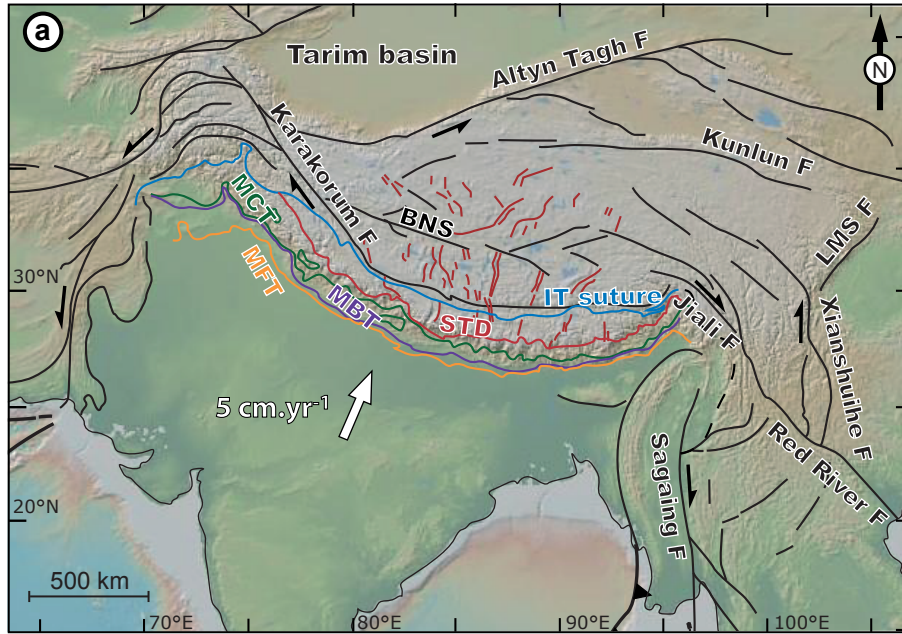

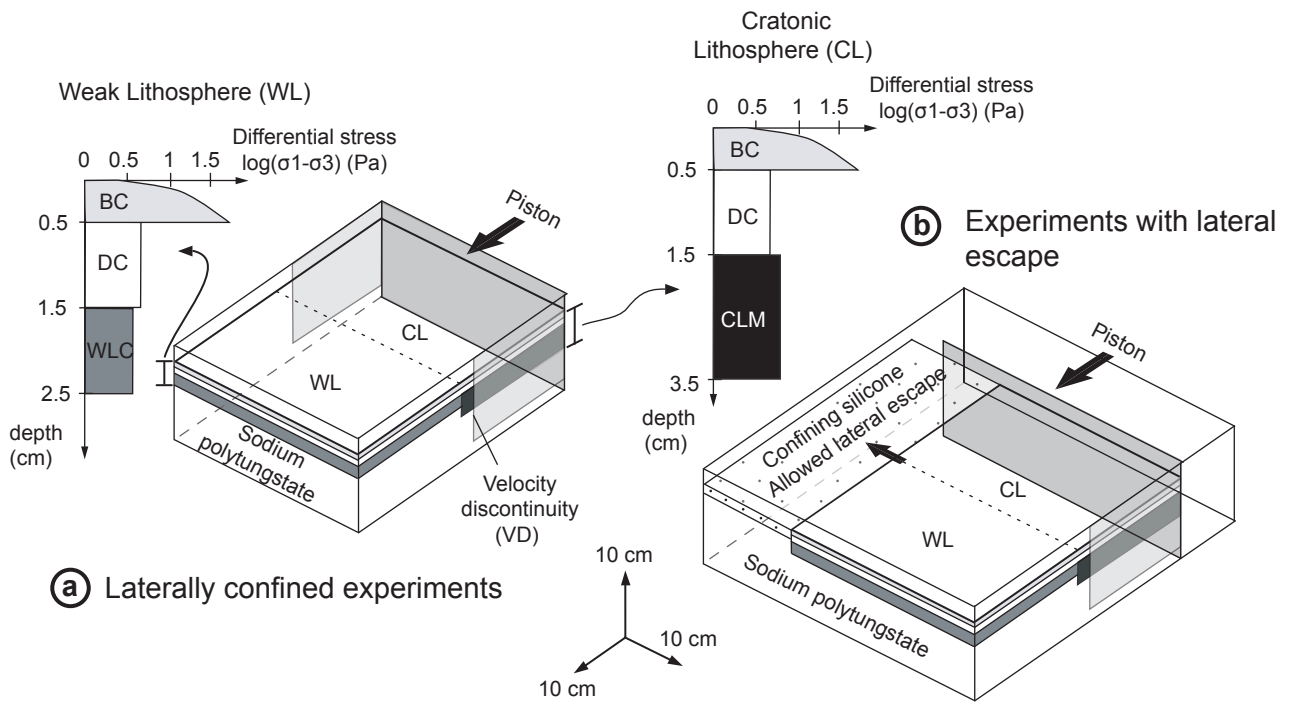

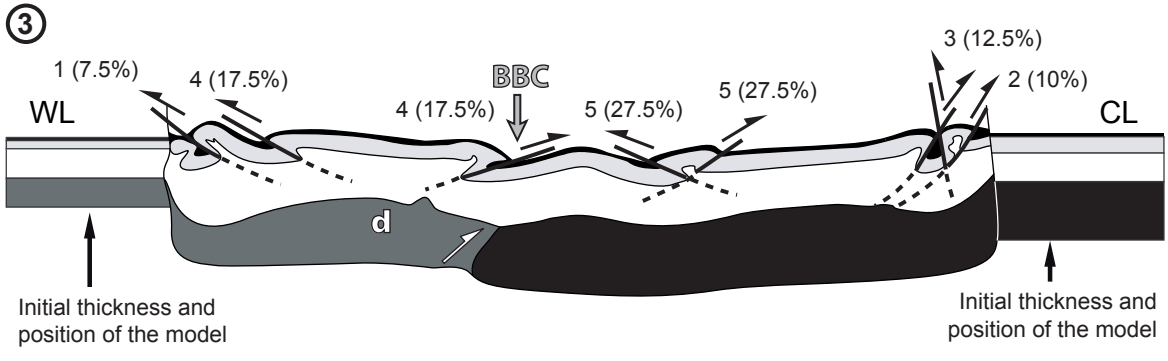
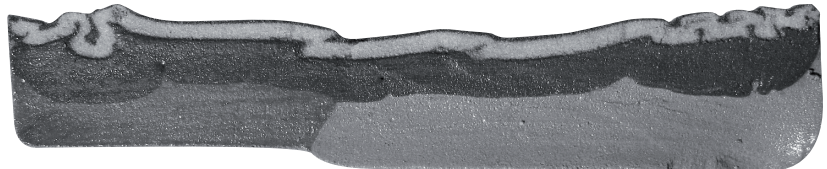
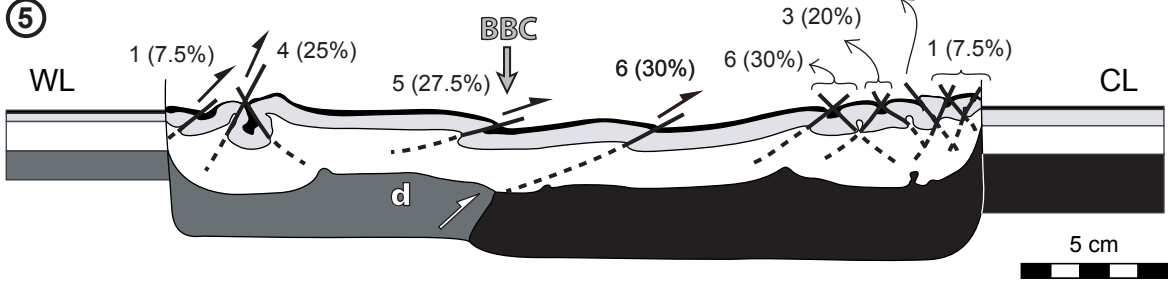
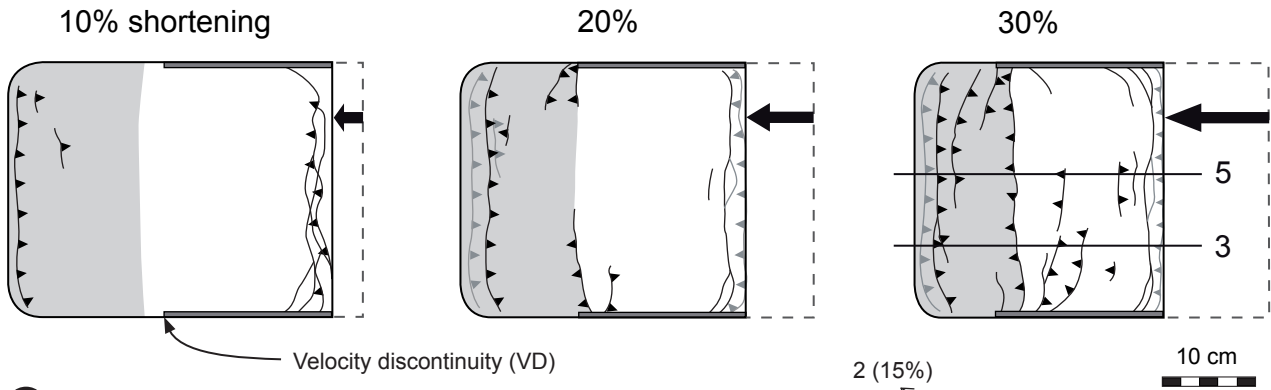

Cross-section view		Plane view	
Brittle crust	Passive markers in ductile crust	Fault	
Ductile crust (DC)	Neutral silicone	Thrust fault	active
Weak lower crust (WLC)	Thickened weak lower crust (TWLC)	Normal fault	active
Cratonic lithospheric mantle (CLM)	Thrust fault		abandoned
Shear sense	Normal fault	Strike-slip fault	
BBC	Indentation	Weak lithosphere brittle crust	
Boundary between WL and CL brittle crusts			

**C1 settings:**

- laterally confined
- 30% shortening
- 2cm/h
- homogeneous sand thickness

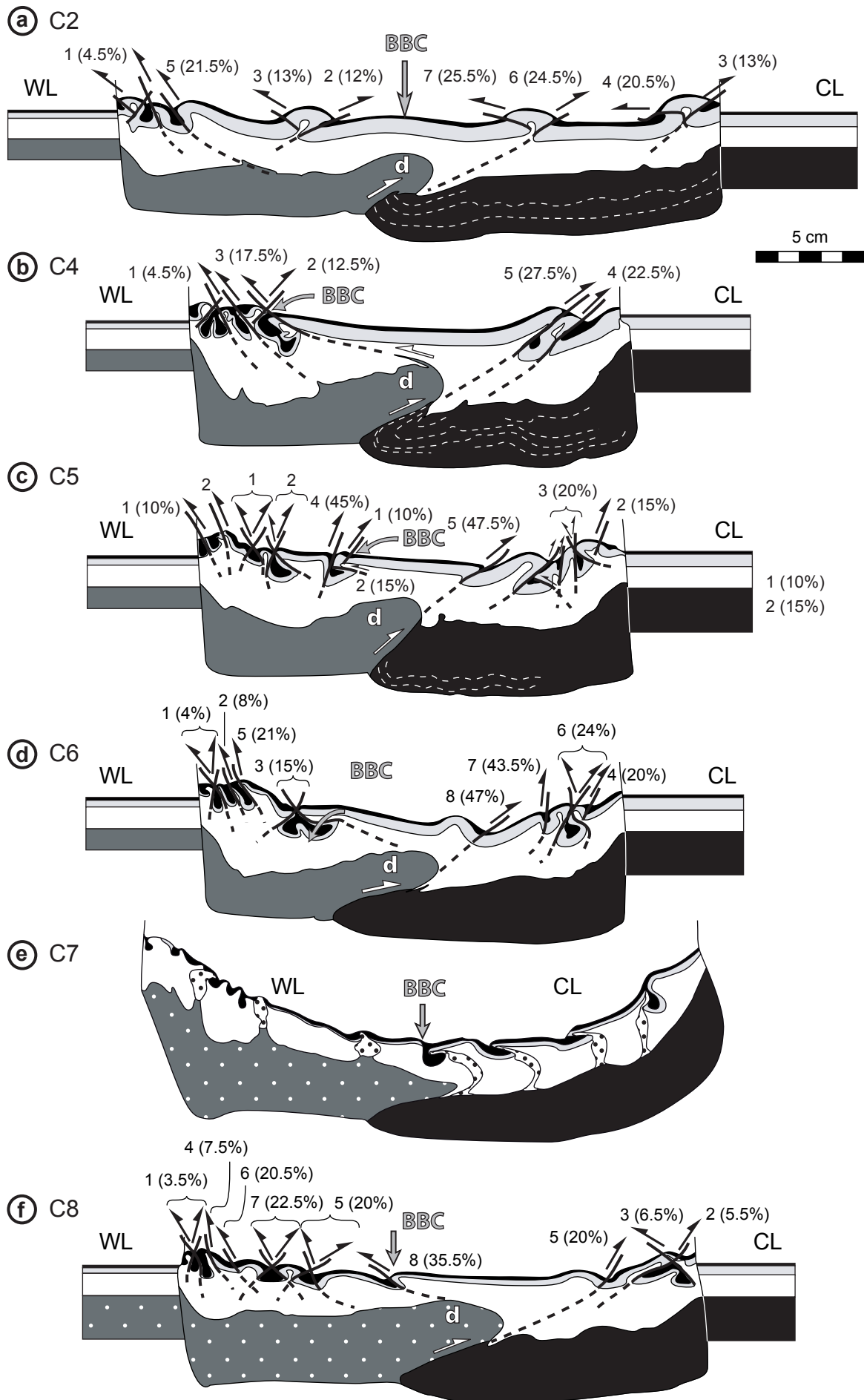

17% shortening

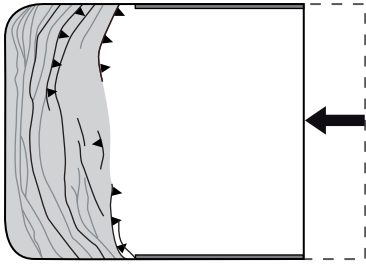

34%

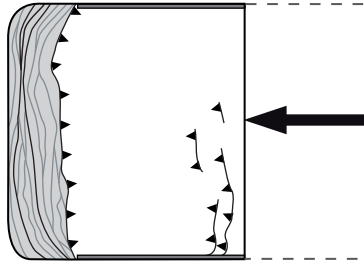

49%

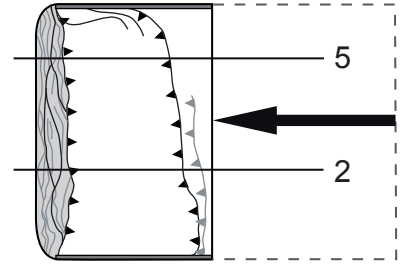

10 cm



⑤

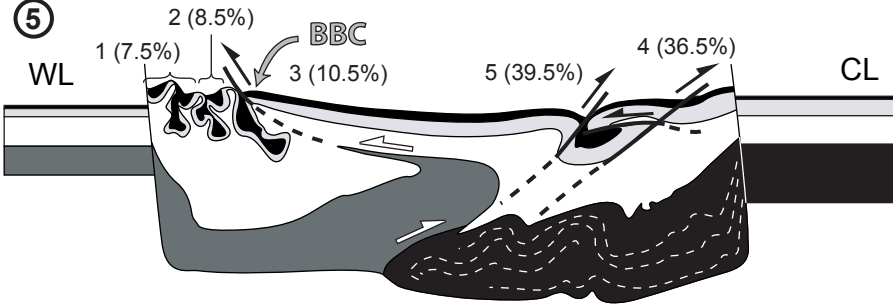

**C3 settings:**

- laterally confined
- 50% shortening
- 0.75 cm/h

②

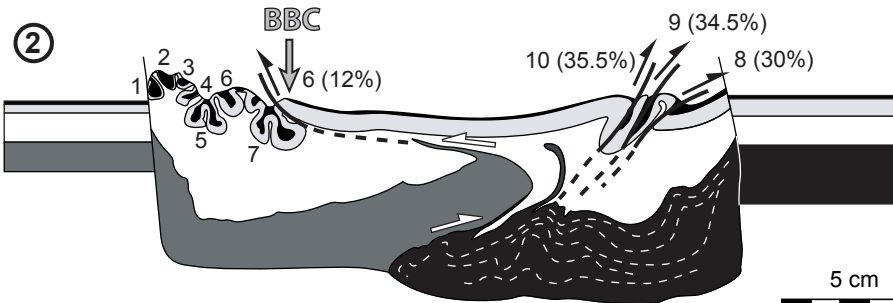

- 1 (3.5%)
- 2 (4.5%)
- 3 (6.5%)
- 4 (7.5%)
- 5 (8.5%)
- 6 (12%)
- 7 (14%)

5 cm

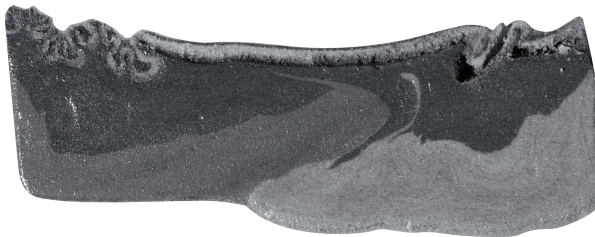

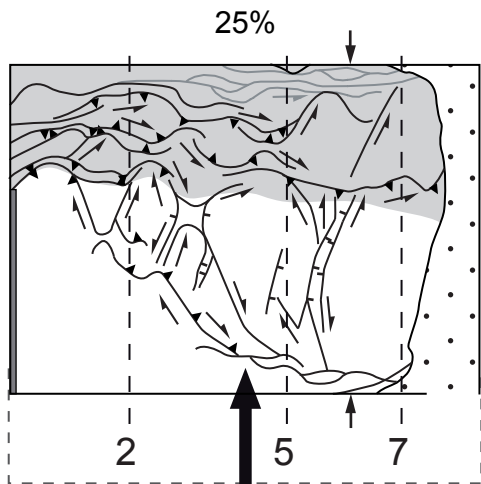
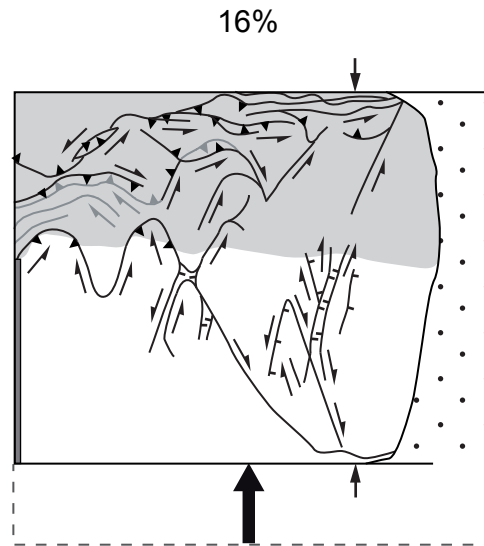
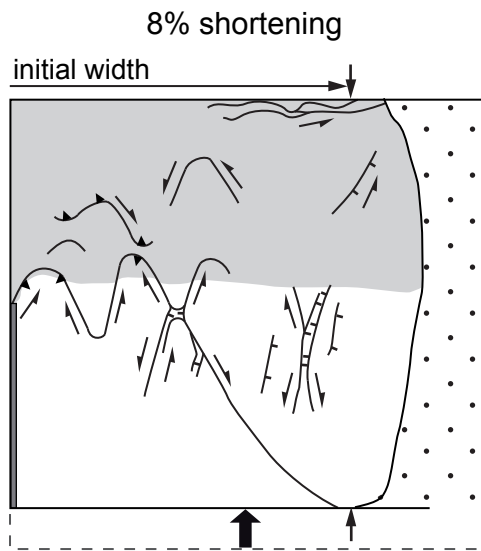

**F2 settings:**

- free lateral boundary
- 1 cm of neutral silicone
- 25% shortening
- 0.75 cm/h

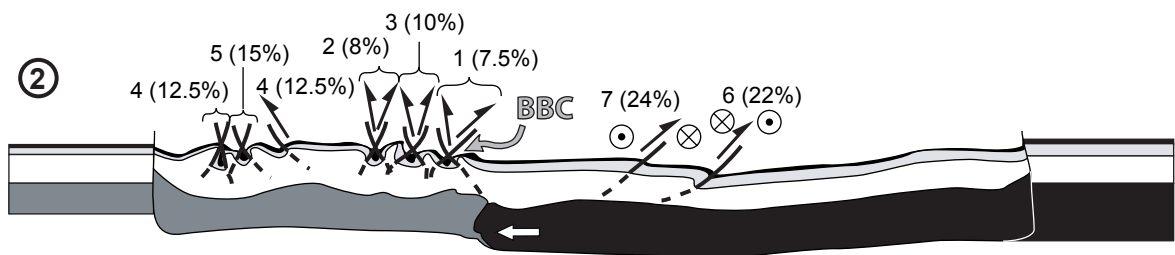
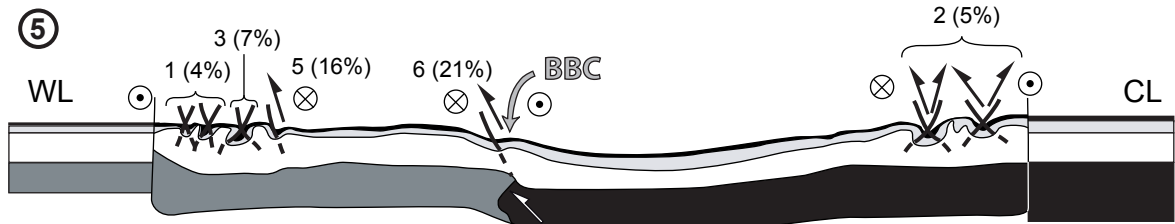
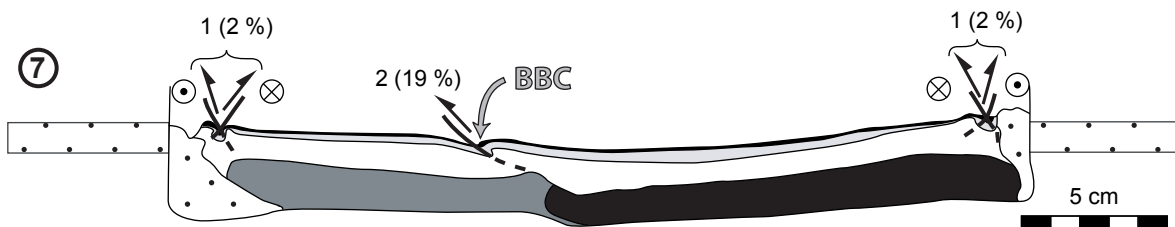



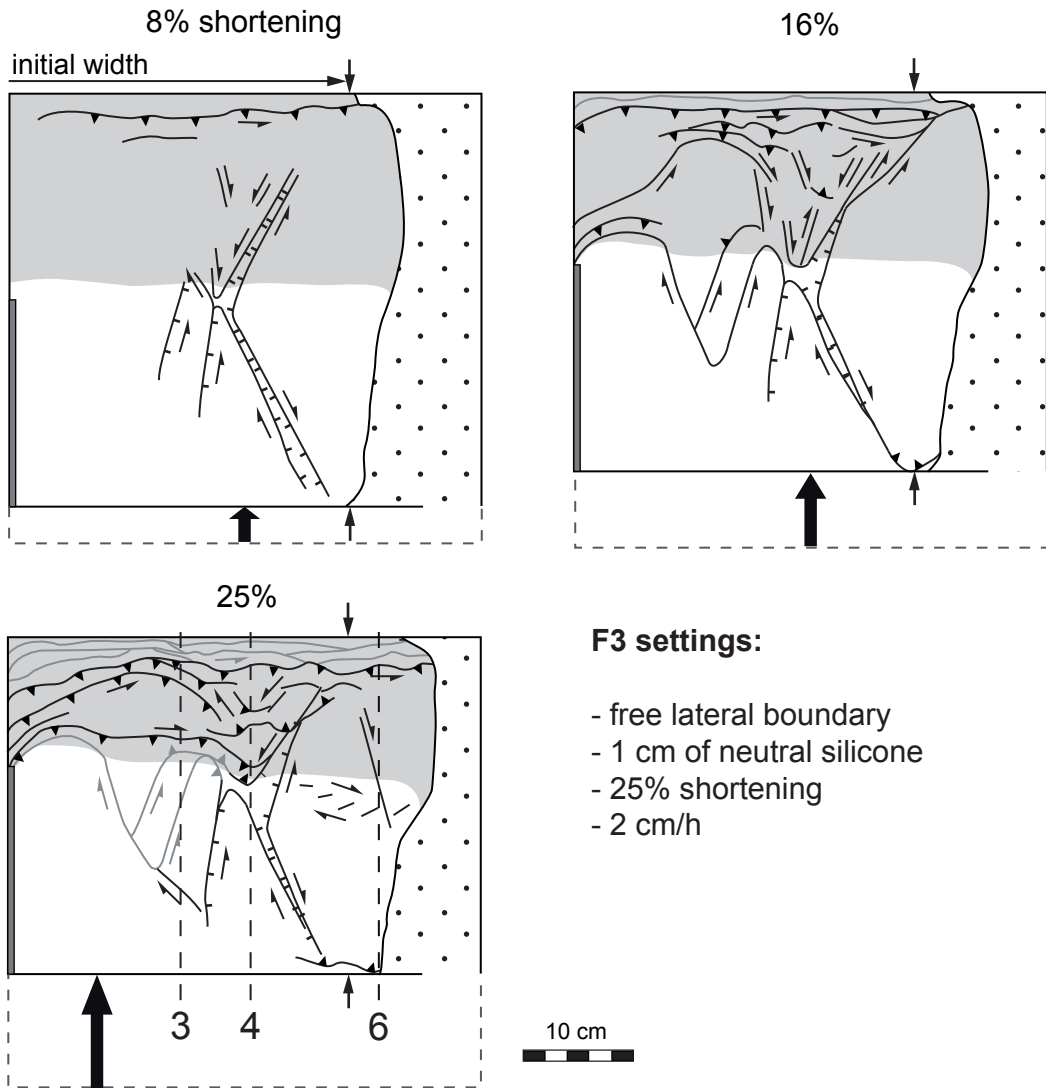

**F3 settings:**

- free lateral boundary
- 1 cm of neutral silicone
- 25% shortening
- 2 cm/h

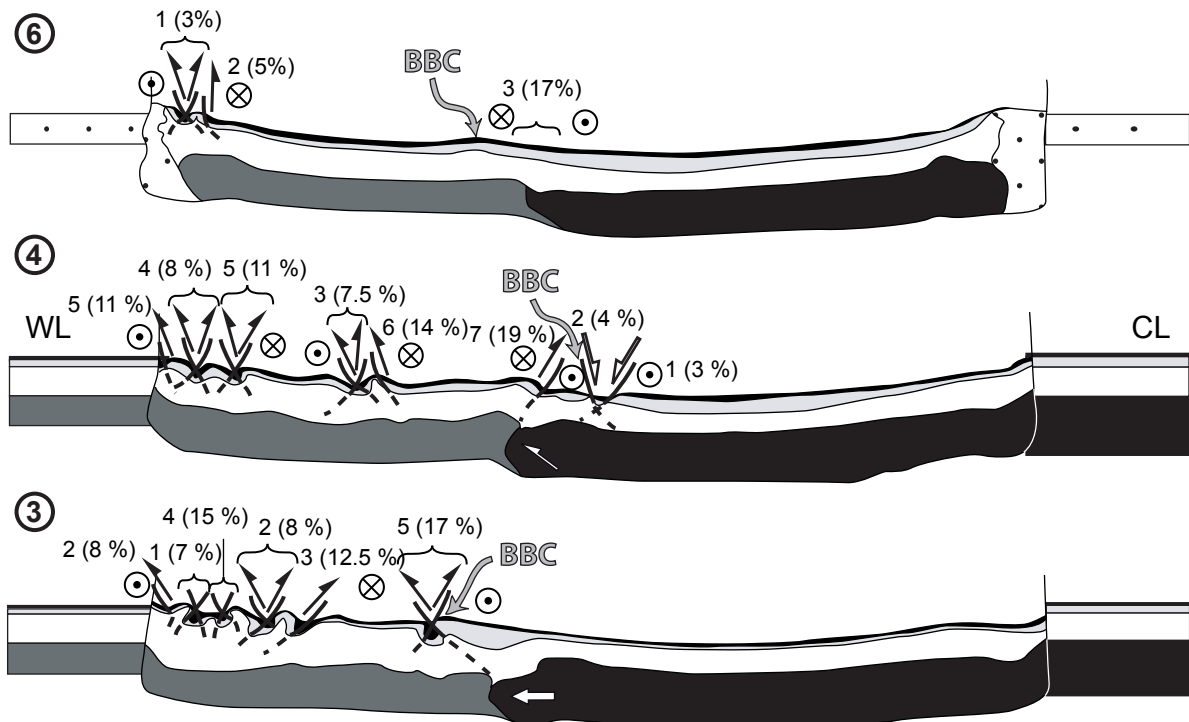

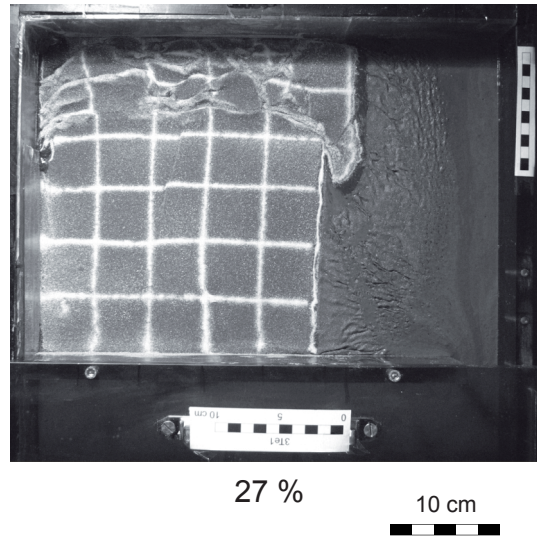
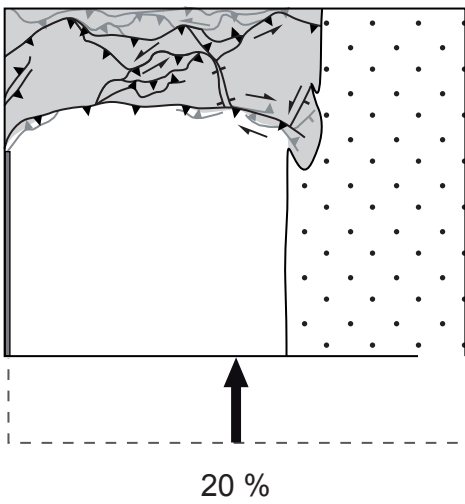
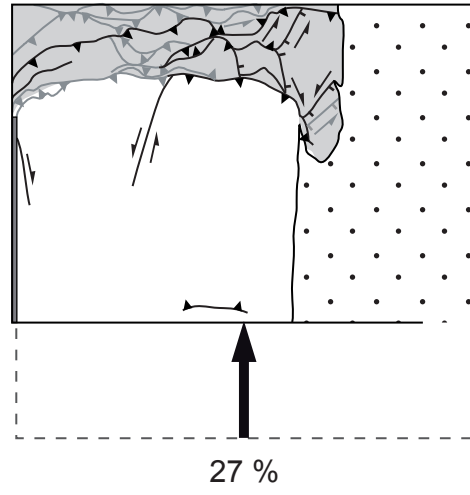
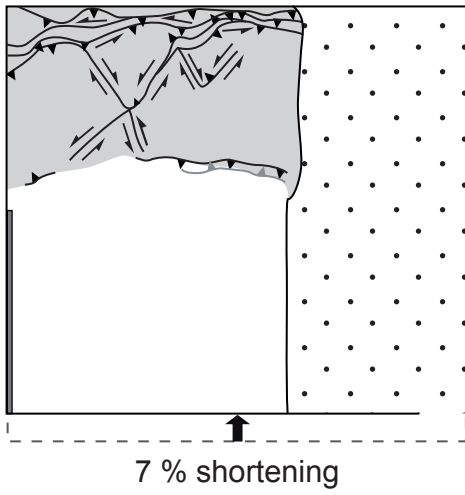

**F1 settings:**

- free lateral boundary
- 3 cm of neutral silicone
- 40% shortening
- 0.75 cm/h

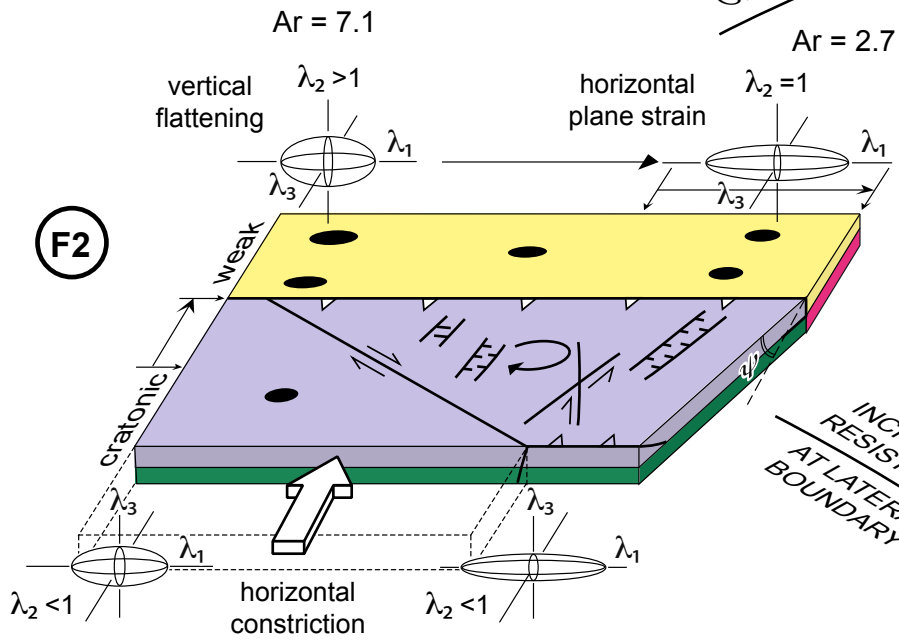
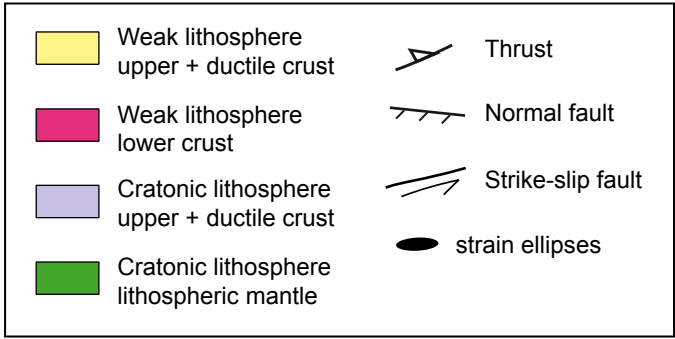

INCREASED OVERALL  
DUCTILE STRENGTH  
OF LITHOSPHERES

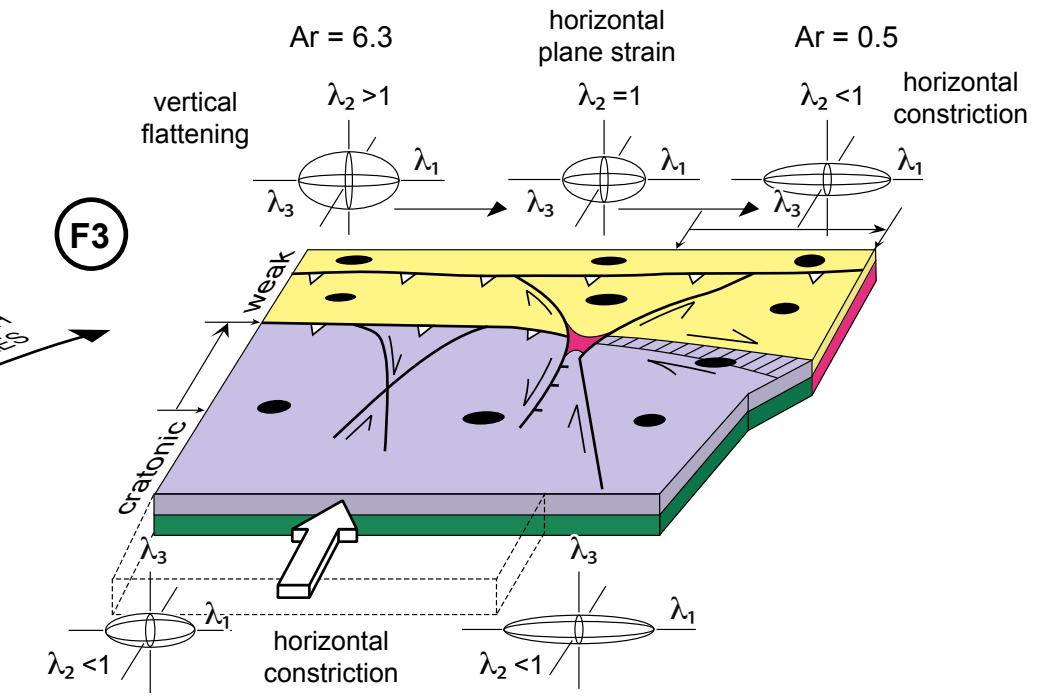

INCREASED  
RESISTANCE  
AT LATERAL  
BOUNDARY

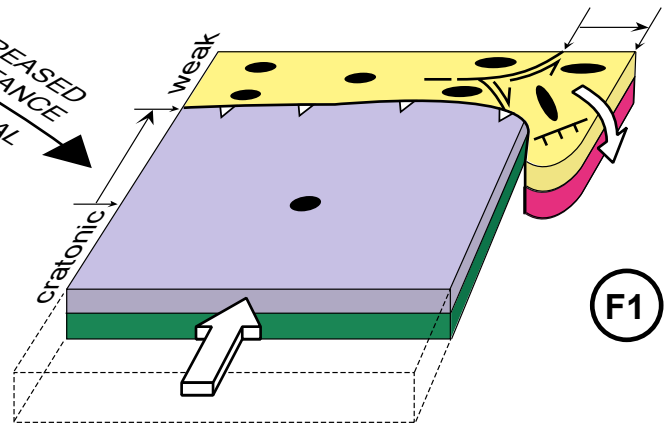

**(a)** Experiment F1

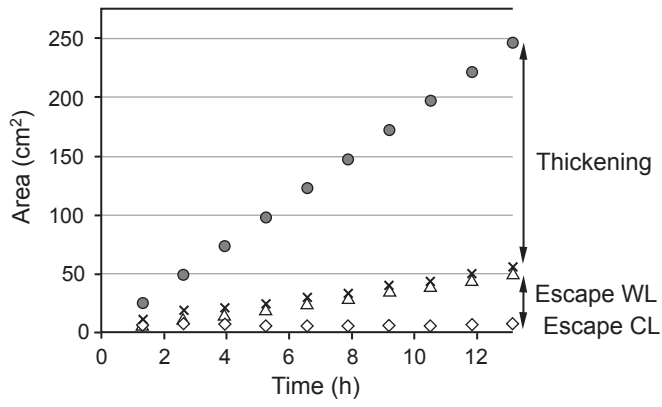

**(b)** Experiment F2

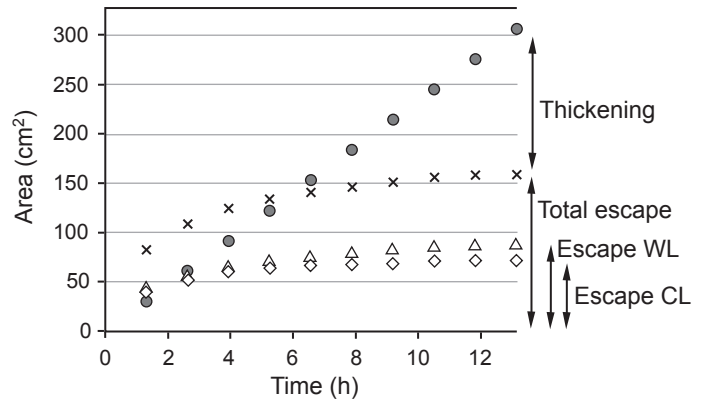

**(c)** Experiment F3

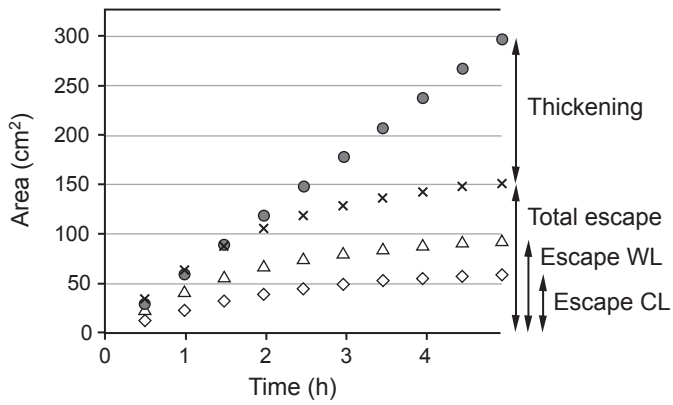

**(d)** Ratio thickening/escape

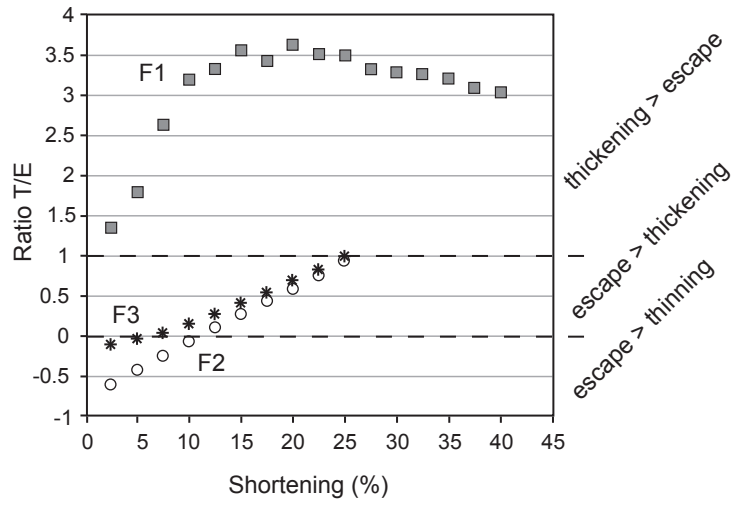

- Area lost by advancing piston
- × Total escaped area
- △ WL escaped area
- ◇ CL escaped area

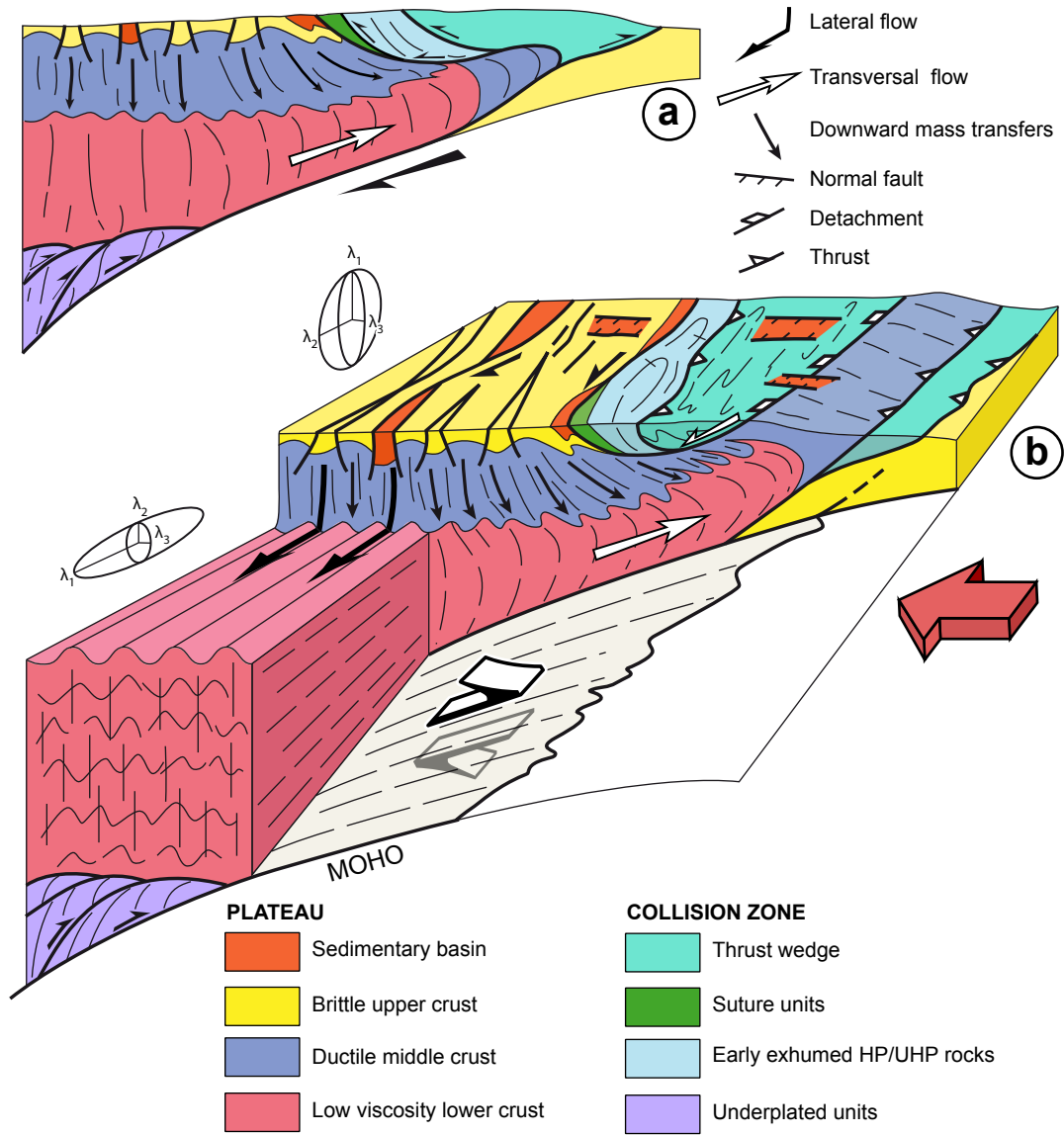

**Table 1.**

Experiment	Finite shortening (%)	Shortening velocity (cm h <sup>-1</sup> )	Lithosphere size (cm)		Sand thickness (cm)		Used silicones* and thicknesses (cm)
			WL	CL	WL	CL	
<b>Confined boundary</b>							
C1	30	2	27x18	27x21.5	0.5	0.5	DC: 1 WLC: 1 CLM: 2
C2	30	0.75	27x21.5	27x18	0.5	0.5	DC: 1 WLC: 1 CLM: 2
C3	50	0.75	27x21.5	27x18	0.4	0.8	DC: 1 WLC: 1 CLM: 2
C4	50	2	27x20	27x19.5	0.4	0.8	DC: 1 WLC: 1 CLM: 2
C5	50	4	27x19.5	27x20	0.4	0.8	DC: 1 WLC: 1 CLM: 2
C6	50	0.4	27x19.5	27x20	0.4	0.8	DC: WLC: 1 CLM: 2
C7	40	2	27x20	27x19.5	0.4	0.8	DC: 1, + markers TWLC: 2 CLM: 2
C8	40	0.75	27x19.5	27x20	0.4	0.8	DC: 1 TWLC: 2 CLM: 2
<b>Lateral escape</b>							
F1	40	0.75	25x19.5	25x20	0.4	0.8	DC: 0.85 WLC: 1.25 CLM: 2 CS: 3
F2	25	0.75	30.5x19	30.5x20.5	0.4	0.8	DC: 0.8 WLC: 1.2 CLM: 2.1 CS: 1
F3	25	2	30.5x19	30.5x20.5	0.4	0.8	DC: 1 WLC: 1 CLM: 2 CS: 1

\* The properties of each silicone are listed in Table 2. CL – cratonic lithosphere; WL – weak lithosphere; DC – ductile crust; WLC – weak lower crust; TWLC – thickened weak lower crust; CLM – cratonic lithospheric mantle; CS – confining silicone.

**Table 2.**

Materials	Viscosity (Pa s)	Density	Thickness (cm)
Sand + ethyle cellulose	-	1.37	0.4 or 0.8
Sodium polythungstate + glycol water	1.2	1.75	7
<b>Silicones</b>			
Ductile crust (DC) blue	$3.57 \times 10^4$	1.40	1
Weak lower crust (WLC) purple	$2.77 \times 10^4$	1.42	1
Thickened weak lower crust (TWLC) brown	$9.51 \times 10^3$	1.42	2
Cratonic lithospheric mantle (CLM) pink	$3.58 \times 10^4$	1.56	2
Confining silicone (CS)	$5.8 \times 10^3$	1.48	1 or 3

**Table 3.**

Layer	$\sigma_1 - \sigma_3$ (Pa)*	
	Shortening rate of $2 \text{ cm h}^{-1}$	Shortening rate of $0.75 \text{ cm h}^{-1}$
Weak lithosphere		
Ductile crust	4.97	1.86
Lower crust	3.90	1.46
Cratonic lithosphere		
Ductile crust	4.97	1.86
Cratonic lithospheric mantle	5.36	2.00

\*Strength profiles for a shortening rate of  $2 \text{ cm h}^{-1}$  are shown in Figure 2.



**Table 4.**

Experiment	$\epsilon_s$		Ar initial		Ar final			
					Internal domain		External domain	
	Weak lithosphere	Cratonic lithosphere	Weak lithosphere	Cratonic lithosphere	Weak lithosphere	Cratonic lithosphere	Weak lithosphere	Cratonic lithosphere
F1			-3.2	1.0				
F2	1.4	1.1	8.3	4.0	7.1	1.8	2.7	0.5
F3	1.1	0.9	7.2	3.8	6.3	1.5	0.5	0.6